



Agenzia Nazionale per le Nuove Tecnologie,
l'Energia e lo Sviluppo Economico Sostenibile



Ministero dello Sviluppo Economico

RICERCA DI SISTEMA ELETTRICO

SIET 01 525 ST10

SPES-3 Two-phase mass flow measurements: technical specifications

S. Gandolfi, M. Greco

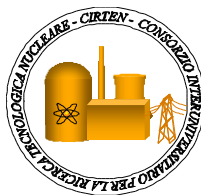

SPES-3- TWO PHASE MASS FLOW MEASUREMENTS: TECHNICAL SPECIFICATIONS

S. Gandolfi, M. Greco

Settembre 2010

Report Ricerca di Sistema Elettrico

Accordo di Programma Ministero dello Sviluppo Economico – ENEA

Area: Produzione e fonti energetiche

Tema: Nuovo Nucleare da Fissione

Responsabile Tema: Stefano Monti, ENEA

Titolo**SPES3 - Two-phase mass flow measurements: technical specifications**

Ente emittente: SIET

PAGINA DI GUARDIA**Descrittori**

Tipologia del documento: Rapporto tecnico/Technical Report
Collocazione contrattuale: Accordo di programma ENEA-MSE: tema di ricerca "Nuovo nucleare da fissione"
Argomenti trattati: Reattori ad acqua leggera/Light Water Reactors

Sommario

This report has been issued in the frame of the second research programme of the ENEA and MSE (Economic Development Ministry) agreement and it is one the deliverables of the task C " IRIS Integral testing- special instrumentation selection" of the work-programme 2 " Evolutionary INTD (International Near Term Deployment) Reactors" of the research theme on "Nuovo Nucleare da Fissione".

The document reports the technical specifications for the choice of two-phase flow instrumentation to be installed on the SPES3 integral facility.

Note

Copia n.

In carico a:

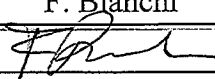
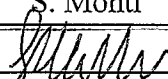
2			NOME			
			FIRMA			
1			NOME			
			FIRMA			
0	EMISSIONE	28/09/2010	NOME	F. Bianchi		S. Monti
			FIRMA			
REV.	DESCRIZIONE	DATA		CONVALIDA	VISTO	APPROVAZIONE



Società Informazioni Esperienze Termoidrauliche
Via Nino Bixio, 27 - 29100 Piacenza (I)

EMITTENTE

issued by

Unità di Produzione

Production Unit

CLIENTE: ENEA

Client :

COMMESSA: 1PN000CA90245

job:

DISCO: CA90245/1

disk

PAGINA: 1 **DI:** 164

page: of

IDENTIFICATIVO:

document:

01 525 ST 09

Classe Ris.:

Confidential:

ALLEGATI:

Enclosures:

TITOLO: SPES3 - TWO-PHASE MASS FLOW MEASUREMENTS: TECHNICAL SPECIFICATIONS

Title:



REDATTORI: S. Gandolfi, M. Greco

prepared by:

LISTA DI DISTRIBUZIONE

distribution list

ENEA	Renato Tinti
ENEA	Fosco Bianchi
SIET S.p.A.	Andrea Achilli
SIET S.p.A.	Gustavo Cattadori
SIET S.p.A.	Stefano Gandolfi
SIET S.p.A.	Matteo Greco
SIET S.p.A.	Roberta Ferri
SIET S.p.A.	Gaetano Tortota
SIET S.p.A.	Cinzia Congiu

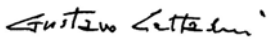
0	14/07/2010	Emissione	S. Gandolfi  M Greco 	G.Cattadori 
REV. Rev.	DATA date	DESCRIZIONE description	REDAZIONE prepared by	APPROVAZIONE approved by

Informazioni strettamente riservate di proprietà SIET SpA - Da non utilizzare per scopi diversi da quelli per cui sono state fornite.
Confidential information property of SIET SpA - Not to be used for any purpose other than those for which it is supplied.

CONTENTS

LIST OF TABLES.....	5
LIST OF FIGURES	7
LIST OF ACRONYMS.....	12
1 SCOPE.....	13
2 INTRODUCTION.....	14
3 MEASUREMENT NEEDS.....	15
3.1 Thermalhydraulic parameters	15
3.2 Measurement location.....	16
4 RELAP5 TRANSIENTS AND BREAK POSTIONS	18
5 VARIABLE RANGE IDENTIFICATION	34
5.1 DVI BREAK TEST	35
5.1.1 DVI DEG break line.....	35
5.1.1.1 Synthesis of achievements for the DVI DEG break.....	44
5.1.2 DVI SPLIT break line.....	45
5.1.2.1 Synthesis of achievements for the DVI SPLIT break.....	54
5.1.3 ADS lines.....	55
5.1.3.1 Synthesis of achievements for the ADS lines.....	56
5.2 EBT BREAK TEST	62
5.2.1 EBT DEG break line	62
5.2.1.1 Synthesis of achievements for the EBT DEG break.....	71
5.2.2 EBT SPLIT break line.....	72
5.2.2.1 Synthesis of achievements for the EBT SPLIT break.....	81
5.2.3 ADS lines.....	82
5.2.3.1 Synthesis of achievements for the ADS lines.....	83
5.3 ADS BREAK TEST	89
5.3.1 ADS ST DEG break line	89
5.3.1.1 Synthesis of achievements for the ADS ST DEG break.....	98
5.3.2 ADS SPLIT break line	99
5.3.2.1 Synthesis of achievements for the ADS SPLIT break	108
5.3.3 ADS lines.....	109

5.3.3.1	Synthesis of achievements for the ADS lines.....	110
5.4	SL BREAK TEST	114
5.4.1	SL DEG break line.....	114
5.4.1.1	Synthesis of achievements for the SL DEG break	123
5.4.2	SL SPLIT break line	124
5.4.2.1	Synthesis of achievements for the SL SPLIT break	133
5.4.3	ADS lines.....	133
5.5	FL BREAK TEST.....	134
5.5.1	FL DEG break line.....	134
5.5.1.1	Synthesis of achievements for the FL DEG break.....	143
5.5.2	FL SPLIT break line.....	144
5.5.2.1	Synthesis of achievements for the FL SPLIT break	153
5.5.3	ADS lines.....	153
6	INSTRUMENT ANALYTICAL CORRELATIONS AND PARAMETER RANGES	154
6.1	Mass flow correlations.....	154
6.2	Parameter ranges	155
6.3	Spool piece instrument correlations	155
7	CONCLUSIONS.....	163
8	REFERENCES.....	164

LIST OF TABLES

Table 4.1: Base cases for the SPES3 break transients	18
Table 5.1: List of the RELAP5 volumes for the DVI DEG break	35
Table 5.2: Maximum and minimum values of the main variables in the	38
Table 5.3: Maximum and minimum values of the main variables in the	42
Table 5.4: Flow regimes function of monitoring volumes and time – DVI DEG LINE	43
Table 5.5: Description of the volumes for the DVI SPLIT break	45
Table 5.6: Maximum and minimum values of the main variables in the	48
Table 5.7: Maximum and minimum values of the main variables in the	52
Table 5.8: Flow regimes function of monitoring volumes and time – DVI SPLIT LINE	53
Table 5.9: Maximum and minimum values of the void fraction and mass flow in the	55
Table 5.10: Maximum and minimum values of the main variables in the	61
Table 5.11: Maximum and minimum values of the main variables in the	61
Table 5.12: Description of the volumes for the EBT DEG break	62
Table 5.13: Maximum and minimum values of the main variables in the	65
Table 5.14: Maximum and minimum values of the main variables in the	69
Table 5.15: Flow regimes function of monitoring volumes and time – EBT DEG line	70
Table 5.16: Description of the volumes for the EBT SPLIT break	72
Table 5.17: Maximum and minimum values of the main variables in the	75
Table 5.18: Maximum and minimum values of the main variables in the	79
Table 5.19: Flow regimes function of monitoring volumes and time – EBT SPLIT LINE	80
Table 5.20: Maximum and minimum values of the void fraction and mass flow in the	82
Table 5.21: Maximum and minimum values of the main variables in the	88
Table 5.22: Maximum and minimum values of the main variables in the	88
Table 5.23: Description of the volumes for the ADS ST DEG break	89
Table 5.24: Maximum and minimum values of the main variables in the	92
Table 5.25: Maximum and minimum values of the main variables in the	96
Table 5.26: Flow regimes function of monitoring volumes and time – ADS ST DEG LINE	97
Table 5.27: Description of the volumes for the ADS ST SPLIT break	99
Table 5.28: Maximum and minimum values of the main variables in the	102
Table 5.29: Maximum and minimum values of the main variables in the	106

Table 5.30: Flow regimes function of monitoring volumes and time – ADS ST SPLIT LINE	107
Table 5.31: Maximum and minimum values of the void fraction and mass flow in the	109
Table 5.32: Maximum and minimum values of the main variables in the	113
Table 5.33: Description of the volumes for the SL-B DEG break	114
Table 5.34: Maximum and minimum values of the main variables in the	117
Table 5.35: Maximum and minimum values of the main variables in the	121
Table 5.36: Flow regimes function of monitoring volumes and time – SL-B DEG LINE	122
Table 5.37: Description of the volumes for the SL-B SPLIT break	124
Table 5.38: Maximum and minimum values of the main variables in the	127
Table 5.39: Maximum and minimum values of the main variables in the	131
Table 5.40: Flow regimes function of monitoring volumes and time – SL-B SPLIT LINE	132
Table 5.41: Description of the volumes for the FL-B DEG break	134
Table 5.42: Maximum and minimum values of the main variables in the	137
Table 5.43: Maximum and minimum values of the main variables in the	141
Table 5.44: Flow regimes function of monitoring volumes and time – FL-B DEG LINE	142
Table 5.45: Description of the volumes for the FL-B SPLIT break	144
Table 5.46: Maximum and minimum values of the main variables in the	147
Table 5.47: Maximum and minimum values of the main variables in the	151
Table 5.48: Flow regimes function of monitoring volumes and time – FL-B SPLIT LINE	152
Table 6.1: Two-phase parameters and measurement instruments	155
Table 6.2: DVI SPLIT break line	158
Table 6.3: EBT SPLIT break line	159
Table 6.4: ADS SPLIT break line	160
Table 6.5: ADS ST Stage-I line	161
Table 6.6: ADS DT Stage-I line	162

LIST OF FIGURES

Figure 3.1: SPES3 facility general view	17
Figure 4.1: SPES3 DVI Break line – Flow Sheet – Steady state conditions	19
Figure 4.2: SPES3 DVI Break line – Flow Sheet – Transient conditions	19
Figure 4.3: SPES3 ADS lines – Flow Sheet – Steady state conditions.	20
Figure 4.4: SPES3 ADS lines – Flow Sheet – Transient conditions	21
Figure 4.5: SPES3 DVI break line system	22
Figure 4.6: SPES3 DVI-B break line nodalization	23
Figure 4.7: SPES3 EBT-B break line system.....	24
Figure 4.8: SPES3 EBT-B break line nodalization	25
Figure 4.9: SPES3 FL-B break line system	26
Figure 4.10: SPES3 FL-B break system nodalization.....	26
Figure 4.11: SPES3 SL-B break system.....	27
Figure 4.12: SPES3 SL-B break system nodalization.....	28
Figure 4.13: SPES3 ADS-ST Stage-I break line system	29
Figure 4.14: SPES3 ADS group of pipes and ADS break lines	30
Figure 4.15: SPES3 ADS single and double train nodalization (front view).....	31
Figure 4.16: SPES3 ADS single train and ADS break line nodalization (top view).....	32
Figure 4.17: SPES3 ADS double train nodalization (top view)	33
Figure 5.1: DVI DEG BREAK LINE Mass flowrate.....	36
Figure 5.2: DVI DEG BREAK LINE liquid and gas velocities UPSTREAM.....	36
Figure 5.3: DVI DEG BREAK LINE pressure UPSTREAM.....	37
Figure 5.4: DVI DEG BREAK LINE liquid and gas temperatures UPSTREAM.....	37
Figure 5.5: DVI DEG BREAK LINE void fraction and quality UPSTREAM	38
Figure 5.6: DVI DEG BREAK LINE liquid and gas velocities DOWNSTREAM.....	39
Figure 5.7: DVI DEG BREAK LINE pressure DOWNSTREAM	40
Figure 5.8: DVI DEG BREAK LINE liquid and gas temperatures DOWNSTREAM	40
Figure 5.9: DVI DEG BREAK LINE void fraction and quality DOWNSTREAM.....	41
Figure 5.10: DVI DEG BREAK LINE volumetric flowrate DOWNSTREAM.....	41
Figure 5.11: DVI SPLIT BREAK LINE mass flowrate	46

Figure 5.12: DVI SPLIT BREAK LINE liquid and gas velocities UPSTREAM.....	46
Figure 5.13: DVI SPLIT BREAK LINE pressure UPSTREAM.....	47
Figure 5.14: DVI SPLIT BREAK LINE liquid and gas temperatures UPSTREAM	47
Figure 5.15: DVI SPLIT BREAK LINE void fraction and quality UPSTREAM.....	48
Figure 5.16: DVI SPLIT BREAK LINE liquid and gas velocities DOWNSTREAM	49
Figure 5.17: DVI SPLIT BREAK LINE pressure DOWNSTREAM	50
Figure 5.18: DVI SPLIT BREAK LINE liquid and gas temperatures DOWNSTREAM.....	50
Figure 5.19: DVI SPLIT BREAK LINE void fraction and quality DOWNSTREAM.....	51
Figure 5.20: DVI SPLIT BREAK LINE volumetric flowrate DOWNSTREAM	51
Figure 5.21: DVI TEST, ADS ST (Stage-I) LINE void fraction UPSTREAM	57
Figure 5.22: DVI TEST, ADS ST (Stage-I) LINE void fraction DOWNSTREAM.....	57
Figure 5.23: DVI TEST, ADS ST (Stage-I) LINE mass flow.....	58
Figure 5.24: DVI TEST, ADS DT (Stage-I) LINE void fraction UPSTREAM	58
Figure 5.25: DVI TEST, ADS DT (Stage-I) LINE void fraction DOWNSTREAM.....	59
Figure 5.26: DVI TEST, ADS DT (Stage-I) LINE mass flow.....	59
Figure 5.27: DVI TEST, ADS ST (Stage-I) LINE volumetric flowrate DOWNSTREAM	60
Figure 5.28: DVI TEST, ADS DT (Stage-I) LINE volumetric flowrate DOWNSTREAM	60
Figure 5.29: EBT DEG BREAK LINE mass flowrate.....	63
Figure 5.30: EBT DEG BREAK LINE liquid and gas velocities UPSTREAM.....	63
Figure 5.31: EBT DEG BREAK LINE pressure UPSTREAM.....	64
Figure 5.32: EBT DEG BREAK LINE liquid and gas temperatures UPSTREAM.....	64
Figure 5.33: EBT DEG BREAK LINE void fraction and quality UPSTREAM	65
Figure 5.34: EBT DEG BREAK LINE liquid and gas velocities DOWNSTREAM.....	66
Figure 5.35: EBT DEG BREAK LINE pressure DOWNSTREAM.....	67
Figure 5.36: EBT DEG BREAK LINE liquid and gas temperatures DOWNSTREAM	67
Figure 5.37: EBT DEG BREAK LINE void fraction and quality DOWNSTREAM.....	68
Figure 5.38: EBT DEG BREAK LINE volumetric flowrate DOWNSTREAM	68
Figure 5.39: EBT SPLIT BREAK LINE mass flowrate	73
Figure 5.40: EBT SPLIT BREAK LINE liquid and gas velocities UPSTREAM.....	73
Figure 5.41: EBT SPLIT BREAK LINE pressure UPSTREAM.....	74
Figure 5.42: EBT SPLIT BREAK LINE liquid and gas temperatures UPSTREAM	74
Figure 5.43: EBT SPLIT BREAK LINE void fraction and quality UPSTREAM.....	75

Figure 5.44: EBT SPLIT BREAK LINE liquid and gas velocities DOWNSTREAM	76
Figure 5.45: EBT SPLIT BREAK LINE pressure DOWNSTREAM	77
Figure 5.46: EBT SPLIT BREAK LINE liquid and gas temperatures DOWNSTREAM.....	77
Figure 5.47: EBT SPLIT BREAK LINE void fraction and quality DOWNSTREAM.....	78
Figure 5.48: EBT SPLIT BREAK LINE volumetric flowrate DOWNSTREAM	78
Figure 5.49: EBT TEST, ADS ST (Stage-I) LINE void fraction UPSTREAM	84
Figure 5.50: EBT TEST, ADS ST (Stage-I) LINE void fraction DOWNSTREAM.....	84
Figure 5.51: EBT TEST, ADS ST (Stage-I) LINE mass flow.....	85
Figure 5.52: EBT TEST, ADS DT (Stage-I) LINE void fraction UPSTREAM	85
Figure 5.53: EBT TEST, ADS DT (Stage-I) LINE void fraction DOWNSTREAM.....	86
Figure 5.54: EBT TEST, ADS DT (Stage-I) LINE mass flow.....	86
Figure 5.55: EBT TEST, ADS ST (Stage-I) LINE volumetric flowrate DOWNSTREAM	87
Figure 5.56: EBT TEST, ADS DT (Stage-I) LINE volumetric flowrate DOWNSTREAM	87
Figure 5.57: ADS ST DEG BREAK LINE mass flowrate.....	90
Figure 5.58: ADS ST DEG BREAK LINE liquid and gas velocities UPSTREAM.....	90
Figure 5.59: ADS ST DEG BREAK LINE pressure UPSTREAM.....	91
Figure 5.60: ADS ST DEG BREAK LINE liquid and gas temperatures UPSTREAM.....	91
Figure 5.61: ADS ST DEG BREAK LINE void fraction and quality UPSTREAM	92
Figure 5.62: ADS ST DEG BREAK LINE liquid and gas velocities DOWNSTREAM.....	93
Figure 5.63: ADS ST DEG BREAK LINE pressure DOWNSTREAM.....	94
Figure 5.64: ADS ST DEG BREAK LINE liquid and gas temperatures DOWNSTREAM	94
Figure 5.65: ADS ST DEG BREAK LINE void fraction and quality DOWNSTREAM.....	95
Figure 5.66: ADS ST DEG BREAK LINE volumetric flowrate DOWNSTREAM.....	95
Figure 5.67: ADS ST SPLIT BREAK LINE mass flowrate	100
Figure 5.68: ADS ST SPLIT BREAK LINE liquid and gas velocities UPSTREAM.....	100
Figure 5.69: ADS ST SPLIT BREAK LINE pressure UPSTREAM.....	101
Figure 5.70: ADS ST SPLIT BREAK LINE liquid and gas temperatures UPSTREAM	101
Figure 5.71: ADS ST SPLIT BREAK LINE void fraction and quality UPSTREAM.....	102
Figure 5.72: ADS ST SPLIT BREAK LINE liquid and gas velocities DOWNSTREAM	103
Figure 5.73: ADS ST SPLIT BREAK LINE pressure DOWNSTREAM	104
Figure 5.74: ADS ST SPLIT BREAK LINE liquid and gas temperatures DOWNSTREAM.....	104
Figure 5.75: ADS ST SPLIT BREAK LINE void fraction and quality DOWNSTREAM.....	105

Figure 5.76: ADS ST SPLIT BREAK LINE volumetric flowrate DOWNSTREAM	105
Figure 5.77: ADS TEST, ADS DT (stage I) LINE void fraction UPSTREAM.....	111
Figure 5.78: ADS TEST, ADS DT (stage I) LINE void fraction DOWNSTREAM.....	111
Figure 5.79: ADS TEST, ADS DT (stage I) LINE mass flow.....	112
Figure 5.80: ADS TEST, ADS DT (stage I) LINE volumetric flowrate DOWNSTREAM	112
Figure 5.81: SL-B DEG BREAK LINE mass flowrate UPSTREAM.....	115
Figure 5.82: SL-B DEG BREAK LINE liquid and gas velocities UPSTREAM.....	115
Figure 5.83: SL-B DEG BREAK LINE pressure UPSTREAM.....	116
Figure 5.84: SL-B DEG BREAK LINE liquid and gas temperatus UPSTREAM.....	116
Figure 5.85: SL-B DEG BREAK LINE void fraction and quality UPSTREAM	117
Figure 5.86: SL-B DEG BREAK LINE liquid and gas velocities DOWNSTREAM.....	118
Figure 5.87: SL-B DEG BREAK LINE pressure DOWNSTREAM.....	119
Figure 5.88: SL-B DEG BREAK LINE liquid and gas temperatures DOWNSTREAM	119
Figure 5.89: SL-B DEG BREAK LINE void fraction and quality DOWNSTREAM.....	120
Figure 5.90: SL-B DEG BREAK LINE volumetric flowrate DOWNSTREAM	120
Figure 5.91: SL-B SPLIT BREAK LINE mass flowrate	125
Figure 5.92: SL-B SPLIT BREAK LINE liquid and gas velocities UPSTREAM.....	125
Figure 5.93: SL-B SPLIT BREAK LINE pressure UPSTREAM.....	126
Figure 5.94: SL-B SPLIT BREAK LINE liquid and gas temperatures UPSTREAM	126
Figure 5.95: SL-B SPLIT BREAK LINE void fraction and quality UPSTREAM.....	127
Figure 5.96: SL-B SPLIT BREAK LINE liquid and gas velocities DOWNSTREAM	128
Figure 5.97: SL-B SPLIT BREAK LINE pressure DOWNSTREAM	129
Figure 5.98: SL-B SPLIT BREAK LINE liquid and gas temperatures DOWNSTREAM.....	129
Figure 5.99: SL-B SPLIT BREAK LINE void fraction and quality DOWNSTREAM.....	130
Figure 5.100: SL-B SPLIT BREAK LINE volumetric flowrate DOWNSTREAM	130
Figure 5.101: FL-B DEG BREAK LINE mass flowrate.....	135
Figure 5.102: FL-B DEG BREAK LINE liquid and gas velocities UPSTREAM.....	135
Figure 5.103: FL-B DEG BREAK LINE pressure UPSTREAM	136
Figure 5.104: FL-B DEG BREAK LINE liquid and gas temperatures UPSTREAM.....	136
Figure 5.105: FL-B DEG BREAK LINE void fraction and quality UPSTREAM	137
Figure 5.106: FL-B DEG BREAK LINE liquid and gas velocities DOWNSTREAM.....	138
Figure 5.107: FL-B DEG BREAK LINE pressure DOWNSTREAM.....	139

Figure 5.108: FL-B DEG BREAK LINE liquid and gas temperatures DOWNSTREAM	139
Figure 5.109: FL-B DEG BREAK LINE void fraction and quality DOWNSTREAM	140
Figure 5.110: FL-B DEG BREAK LINE volumetric flowrate DOWNSTREAM	140
Figure 5.111: FL-B SPLIT BREAK LINE mass flowrate	145
Figure 5.112: FL-B SPLIT BREAK LINE liquid and gas velocities UPSTREAM	145
Figure 5.113: FL-B SPLIT BREAK LINE pressure UPSTREAM	146
Figure 5.114: FL-B SPLIT BREAK LINE liquid and gas temperatures UPSTREAM	146
Figure 5.115: FL-B SPLIT BREAK LINE void fraction and quality UPSTREAM	147
Figure 5.116: FL-B SPLIT BREAK LINE liquid and gas velocities DOWNSTREAM	148
Figure 5.117: FL-B SPLIT BREAK LINE pressure DOWNSTREAM	149
Figure 5.118: FL-B SPLIT BREAK LINE liquid and gas temperatures DOWNSTREAM	149
Figure 5.119: FL-B SPLIT BREAK LINE void fraction and quality DOWNSTREAM	150
Figure 5.120: FL-B SPLIT BREAK LINE volumetric flowrate DOWNSTREAM	150

LIST OF ACRONYMS

ADS	Automatic Depressurization System
ANM	Annular mist
BBY	Bubbly
CHF MPR	mist pre-CHF
CV	Containment Volume
DBE	Design Basis Event
DEG	Double Ended Guillotine
DT	Double Train
DVI	Direct Vessel Injection
DW	Dry Well
EBT	Emergency Boration Tank
EHR	Emergency Heat Removal System
FL	Feed Line
HST	Horizontal Stratified
LGMS	Long Term Gravity Make-up System
LOCA	Loss of coolant Accident
LWR	Light Water Reactor
PSS	Pressure Suppression System
RV	Reactor Vessel
RC	Reactor Cavity
SG	Steam Generator
SL	Steam Line
SLG	Slug
SPES	Simulatore Per Esperienze di Sicurezza
ST	Single Train
WMS	Wire Mesh Sensor

1 SCOPE

The purpose of this document is to define the technical specifications for the choice of two-phase flow instrumentation to be installed on the SPES3 test facility.

To reach that goal, a detailed analysis of thermalhydraulic conditions in the plant locations where two-phase flow occurs has been done by using the RELAP5 numerical code.

2 INTRODUCTION

The SPES-3 facility is an integral simulator of the IRIS reactor, suitable to test the plant response to postulated design basis accidents and to provide experimental data for code validation and IRIS plant safety analyses [1].

The IRIS reactor is an advanced medium size nuclear reactor, based on the proven technology of Pressurized (Light) Water Reactors with an innovative integral configuration and safety features suitable to cope with Loss of Coolant Accidents through a dynamic coupling of the primary and containment systems. It is under design in the frame of an international consortium led by Westinghouse including industries, universities and research centers.

All the primary, secondary and containment systems are simulated in SPES3 with 1:100 volume and power scaling, 1:1 elevation scaling and the fluid at IRIS pressure and temperature nominal conditions [2].

A test matrix establishes the simulation of a series of SBLOCAs and secondary breaks which data will be fundamental for the certification process IRIS is going to undergo by the US-NRC [1].

The SBLOCA tests and the secondary side breaks foresee two-phase flow conditions in the pipes simulating the break flow paths, in critical flow during the early phases of the transients and driven by differential pressure in the later phases.

The measurements of two-phase flow have never been an easy task in the experimental thermalhydraulics and the need of such measures in the SPES3 facility has led to investigate different possibilities and evaluation methods to record mass flows and energies, in particular to focus on the analysis of the thermalhydraulic conditions that occur in the interested pipe lines during the investigate transients.

Data obtained by the SPES3 facility simulation with the RELAP5 thermalhydraulic code and the execution of Design Basis Accident transients have provided the reference conditions to define the main thermalhydraulic parameter ranges and a selection of instruments suitable to measure them and derive the required quantities [3], [4].

3 MEASUREMENT NEEDS

3.1 Thermalhydraulic parameters

The thermalhydraulic parameters that need to be investigated in order to evaluate the behaviour of the SPES3 facility, Figure 3.1, and to identify the mass and energy balance in two-phase conditions are:

- Temperature;
- Pressure;
- Mass flowrate;
- Flow regimes;
- Mixture quality;
- Slip ratio.

In two-phase flow conditions, temperatures of the liquid and gas phases are different, since the thermal dynamic equilibrium is not preserved. Anyway, the RELAP5 pre-test analyses of the LOCA and break transients [4] demonstrate that the liquid vs. gas temperature difference is negligible.

On the basis of the RELAP5 results, the fluid temperature will be measured by conventional instruments.

Pressure is one of the most fundamental parameters to be measured. The saturation temperature, enthalpy and density values depend on it. It will be measured by conventional instruments.

The two-phase mass flowrate cannot be directly measured by conventional instruments, e.g. Venturi or Coriolis meters that are usually utilised in single phase flow conditions. The need to limit intrusive measures and the occurrence of different flow regimes (bubbly, churn, annular, horizontal stratified) require special instrumentation, typically set up by two or more instruments. The knowledge of the flow regime is important in the definition of the instrument specifications.

The mixture quality is necessary to estimate the energy balance. A direct measurement of the steam quality is not possible, but it will be obtained by means of the slip ratio value and the mixture void fraction or the mixture density.

The mixture density can be measured by means of non or limited intrusive instruments as Wire Mesh or Capacitive Wire sensors or Gamma-ray densitometers.

Other quantities like mixture velocity, void fraction and momentum flux, necessary to obtain the final required quantity (two-phase mass flow), cannot be measured by conventional instruments and need to be derived by means of particular devices, namely spool piece, which allow to measure typical physical parameters in two-phase conditions.

The spool piece device consists in a set of heterogeneous instruments that give information to be correlated by means of analytical tools in order to have the main variables (mass flowrate, quality).

The devices that constitute the spool piece must be able to resist to all the working conditions foreseen in the SPES facility.

Reference [5] reports the results of a research on possible instruments to measure the two-phase mass flow in the SPES3 facility. A series of criteria has been investigated to select such instruments up to identify a limited number of devices that can potentially satisfy the SPES3 requirements. This document starts from the achievements of reference [5] and defines the ranges of quantities to be measured towards a final selection of instruments.

3.2 Measurement location

The position for the break simulation in SPES3 are specified in [1] and shown in detail in [3] where details of the ADS lines are reported too. Break pipe lines and ADS lines represent a-priori the places where it is necessary to evaluate both mass flow and energy in two-phase conditions. Details of conditions coming from the analysis of the test matrix transients are summarized in section 6 of this document [1].

The special instrumentation, i.e. the spool piece, will be installed in the positions where the two-phase flow conditions are foreseen.

The pre-test analyses of the test matrix transients with the RELAP5 code allows the identification of those break lines where void fraction experiments significant values. The RELAP5 results of the transients are reported in [4]. The investigation of specific variables, properly selected among the set of output data of RELAP5 calculations, allows to identify the pipes with prevalently single-phase water or steam (measurable by conventional instruments, e.g. venturimeters or orifices) and those with a significant two-phase mass flow (necessarily measurable by spool pieces).

The lines identified in SPES3 where two-phase flow may occur are globally fourteen, including the break lines, split and DEG, and the ADS lines Stage-I and Stage-II [3].

In order to limit the number of installed spool pieces to those strictly necessary, it has been decided to establish criteria, in terms of parameters and range of evaluation, suitable to identify those incidents and lines where two-phase conditions are relevant. The details of this process are described in section 4 of this document.

Due to the high pressure in SPES3, upstream of the break valve (primary side pressure), it has been decided to install the spool piece downstream of the break valve (containment pressure). Anyway, a venturimeter will be installed on each line upstream of the break valve to measure the mass flow until the fluid remains single-phase (early phases of the transients), be it liquid or steam. Due to the presence of a calibrated orifice at the break valve and the pressure difference between primary and containment systems, a critical flow occurs at the breaks with strongly different velocity between the phases.

As the break lines are longer downstream than upstream of the valves, the spool piece installation in the longer part allows to limit the instrument impact on the flow profile.

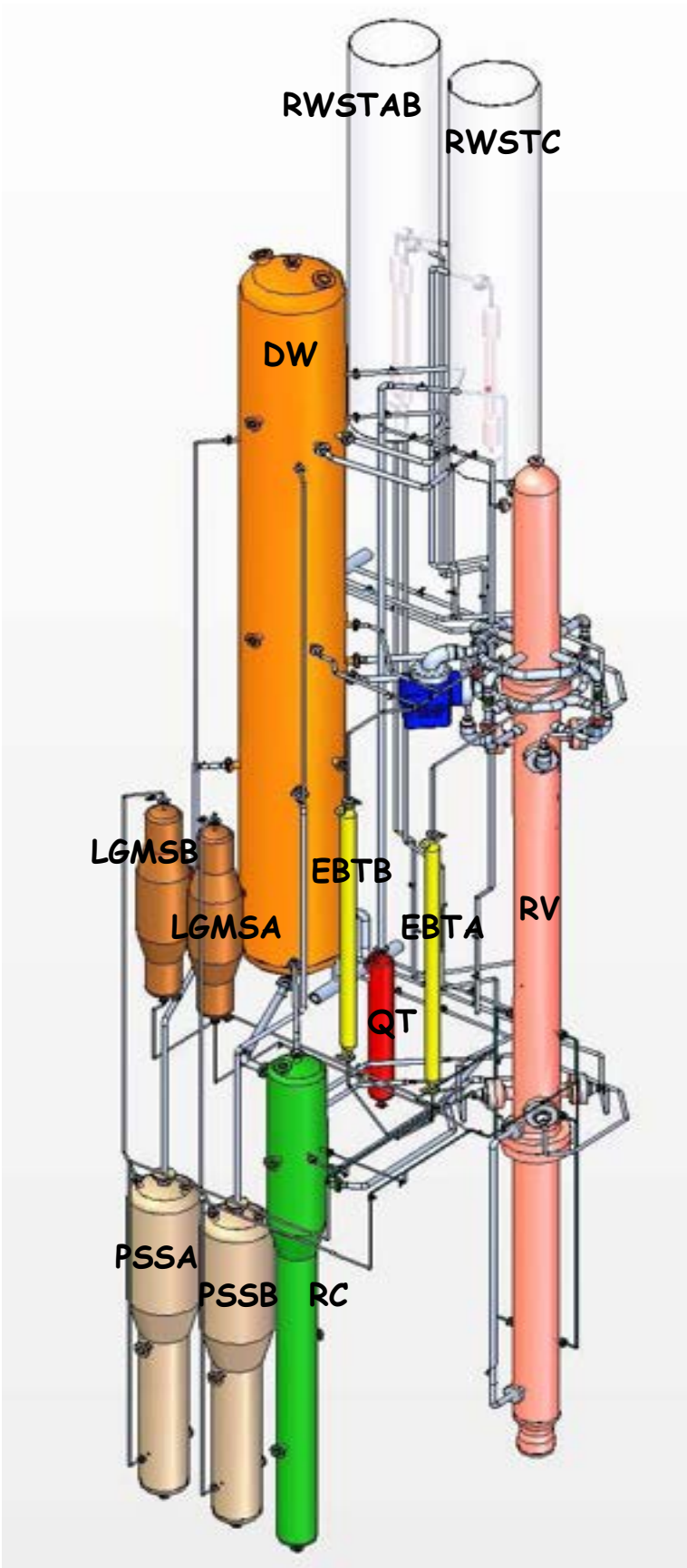

Figure 3.1: SPES3 facility general view

4 RELAP5 TRANSIENTS AND BREAK POSTIONS

Five base transient case simulations have been utilized to study the two-phase flow occurrence in the break lines and such transients have been chosen coherently with the test matrix [1] and reported in [4]. Such cases are simulated starting from full power steady conditions, in order to make easier the comparison between the facility and the IRIS plant calculation results. Due to a limitation on the available power at SIET laboratories, the actual SPES3 tests will be run starting from reduced power (65%) steady conditions, reducing accordingly the primary and secondary mass flows to have the same temperature difference between core inlet and outlet. This does not affect the break mass flow and related thermo-dynamic conditions, being the flow driven by the pressure difference, equal to the full power cases. On this basis, it is correct utilize the available RELAP results to investigate the break line flow conditions.

The investigated cases cover the main primary system LOCAs and secondary system breaks and the ADS lines are involved in the studied transients.

The five investigated base cases are shown in Table 4.1 [4].

Table 4.1: Base cases for the SPES3 break transients

RELAP base case number	Case name	Description
SPES 89	DVI break	Double Ended Guillotine break of the Direct Vessel Injection Line B
SPES 90	EBT break	Double Ended Guillotine break of the top connection between the Emergency Boration Tank and the Reactor Vessel B
SPES 91	ADS break	Double Ended Guillotine break of the Automatic Depressurization System B, on the Single Train Line
SPES 92	SL break	Double Ended Guillotine break of the Steam Line B
SPES 93	FL break	Double Ended Guillotine break of the Feed Line B

For each case, the Double Ended Guillotine (DEG) break is simulated, representing a complete severance of the pipe. The split break, perforation of the pipe without pipe axis movement, is foreseen in the test matrix but not yet simulated at the time of this work.

In the SPES3 facility, each break is constituted as follows:

- three valves;
- three lines: the main pipe and two break lines, SPLIT (RV side) and DEG (containment side).

During the steady state of operations, the two valves localized on the break lines are closed, whereas the valve on the main pipe is open, as shown in Figure 4.1.

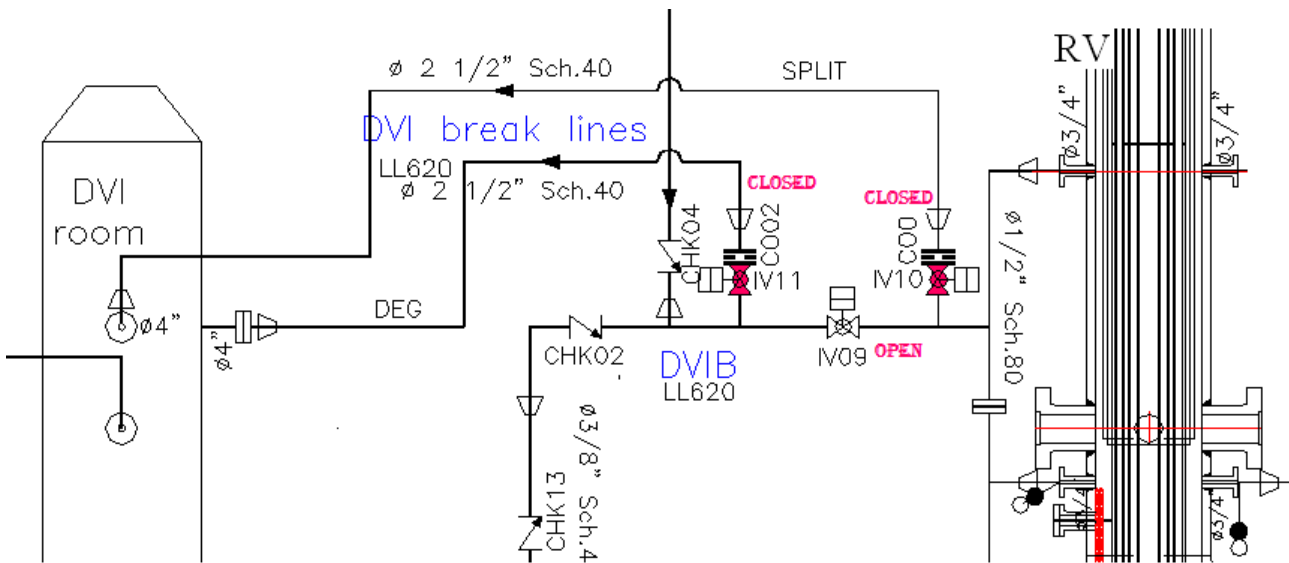

Figure 4.1: SPES3 DVI Break line – Flow Sheet – Steady state conditions

The Figure 4.1 represents the connection between the RV and the RC by the DVI-B.

An analogous break system is used also for the EBT-B line and ADS lines and for the SL and FL breaks. The break lines (SPLIT and DEG) connect the RV to the containment at the same elevation of the pipe which rupture is being simulated, so the DVI and FL breaks exit in the RC, the EBT, ADS and FL breaks exit in the DW.

When a break occurs, the valves switch from “closed” to “open” and vice-versa and water mass and energy are transferred from the RV to the containment, as shown in Figure 4.2.

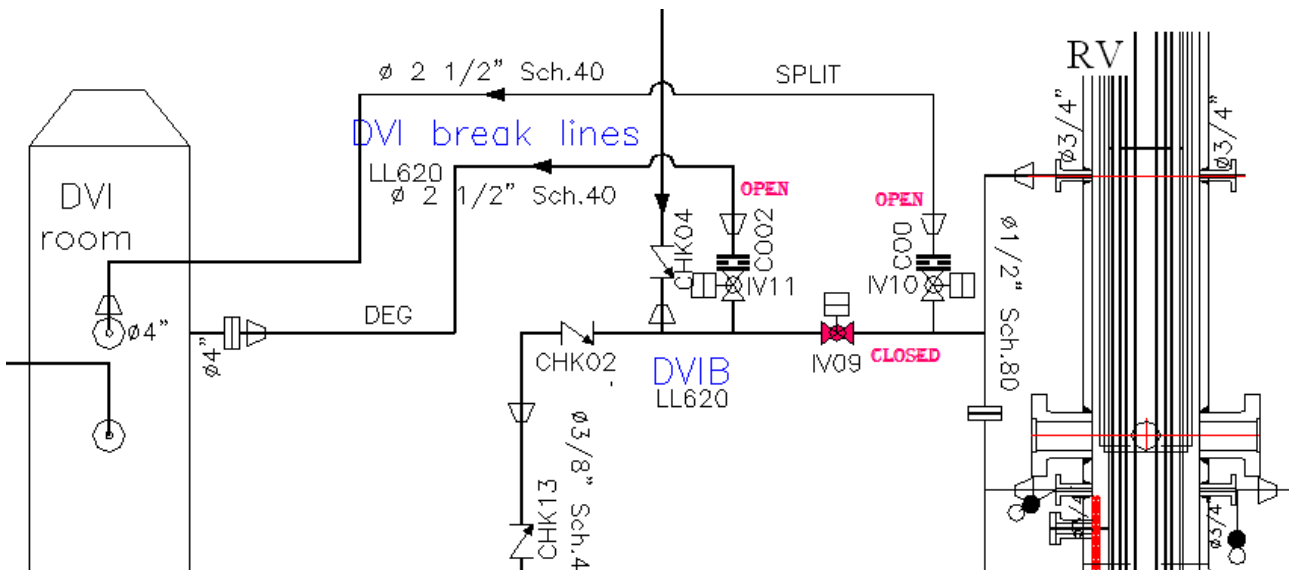

Figure 4.2: SPES3 DVI Break line – Flow Sheet – Transient conditions

In general, during the steady state, the SPLIT break line, being directly connected to the RV, contains fluid at the primary conditions: water at DVI, EBT and FL and steam at the ADS and SL, while the DEG break lines contain fluid at the containment conditions (air).

The test matrix [1] indicates ten break test positions in which it is necessary to evaluate both mass flow and energy balance in two-phase flow conditions:

- DVI Split line break;
- DVI DEG line break;
- EBT Split line break;
- EBT DEG line break;
- ADS-ST Split line break;
- ADS-ST DEG line break;
- SL Split line break;
- SL DEG line break;
- FL Split line break;
- FL DEG line break.

Moreover the two ADS trains (single and double train), each consisting of Stage-I and Stage-II, add four more lines that can experiment two-phase flow and water and gas mixture.

Each ADS line contains a valve. During the steady state such valves are close, as shown in Figure 4.3.

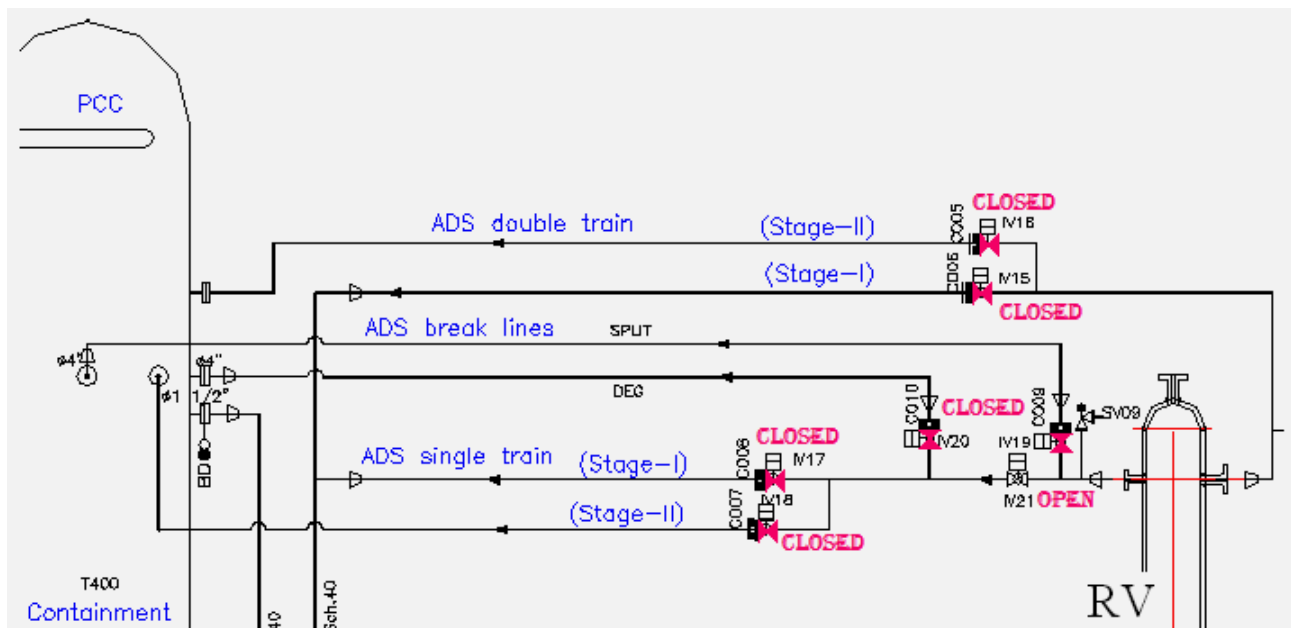

Figure 4.3: SPES3 ADS lines – Flow Sheet – Steady state conditions.

During a transient, when a high containment pressure signal occurs contemporarily to a low pressurizer pressure signal, the ADS Stage-I valves are opened while the ADS Stage-II open later following a low LGMS mass signal. The transient configuration for ADS is shown in Figure 4.4.

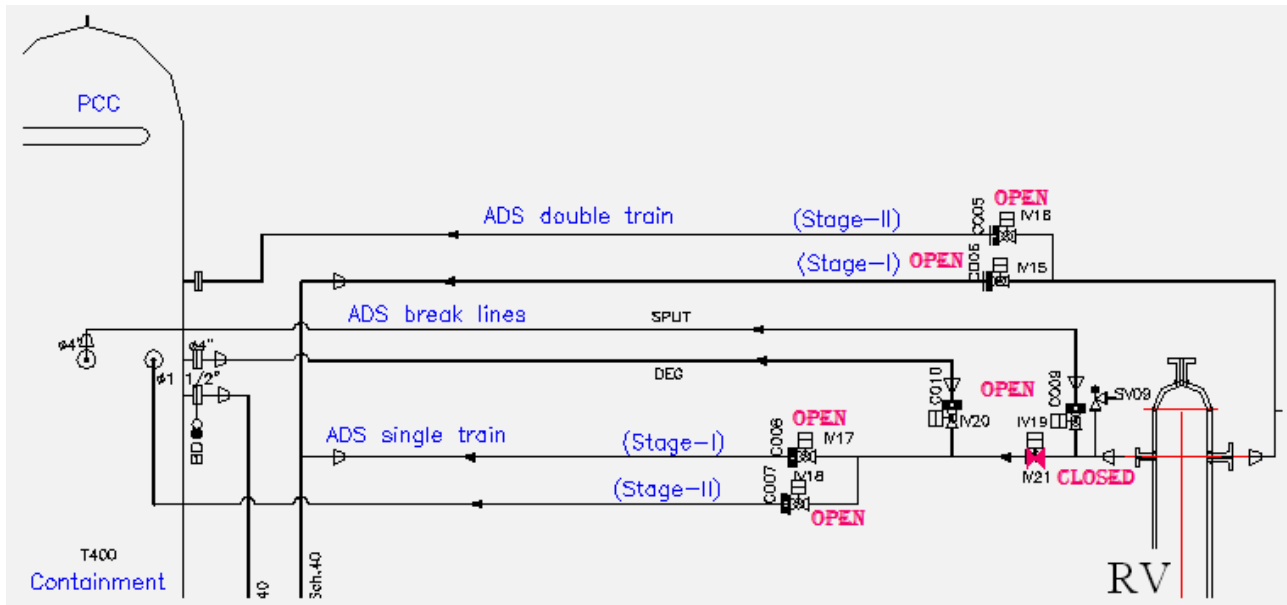

Figure 4.4: SPES3 ADS lines – Flow Sheet – Transient conditions

The RELAP5 results analyzed in this work are mainly related to the break lines, while the description of the whole transients is available in [4]. As all the five simulated transients are Double Ended Guillotine breaks, data for both the SPLIT and DEG lines are available.

The RELAP5 code allows for the determination of the flow main characteristics in each volume that is included in the nodalization [3].

For each break position, two different monitoring volumes were defined for the extraction of the variables necessary to set the instrument range. Such monitoring volumes are located upstream and downstream the valve with calibrated orifice that simulates the correct size of the break.

The upstream monitor volume is always the one just before the break valve, in each test.

The downstream monitor volumes are chosen in the position where it is expected to install the spool piece where the pipe geometric discontinuities (e.g. bends) have little influence on the flow profile (straight pipe portion).

The preliminary check of the pre-test data, as reported in [4], highlighted the presence of two-phase condition in the ADS ST and DT lines (stage I and Stage-II), whenever such lines are in operation. This has led to select monitor volumes on such lines to investigate the problem. Due to the nodalization configuration, the valve downstream volume has been chosen together with an upstream volume on a straight portion of the pipe.

Among the others, flow regime data have been extracted from the RELAP5 results for each break line, considering in particular the downstream volumes sequence, in order to evaluate the flow pattern variation in the transient evolution.

Figure 4.5, Figure 4.6, Figure 4.7, Figure 4.8, Figure 4.9, Figure 4.10, Figure 4.11, Figure 4.12, Figure 4.13, Figure 4.14, Figure 4.15, Figure 4.16 and Figure 4.17 show the studied line configuration and the related RELAP5 nodalization [3].

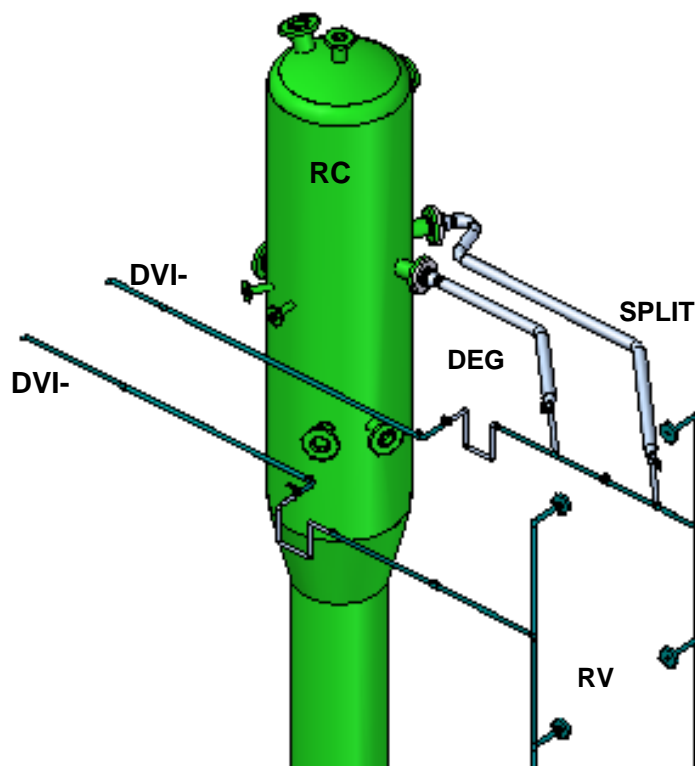

Figure 4.5: SPES3 DVI break line system

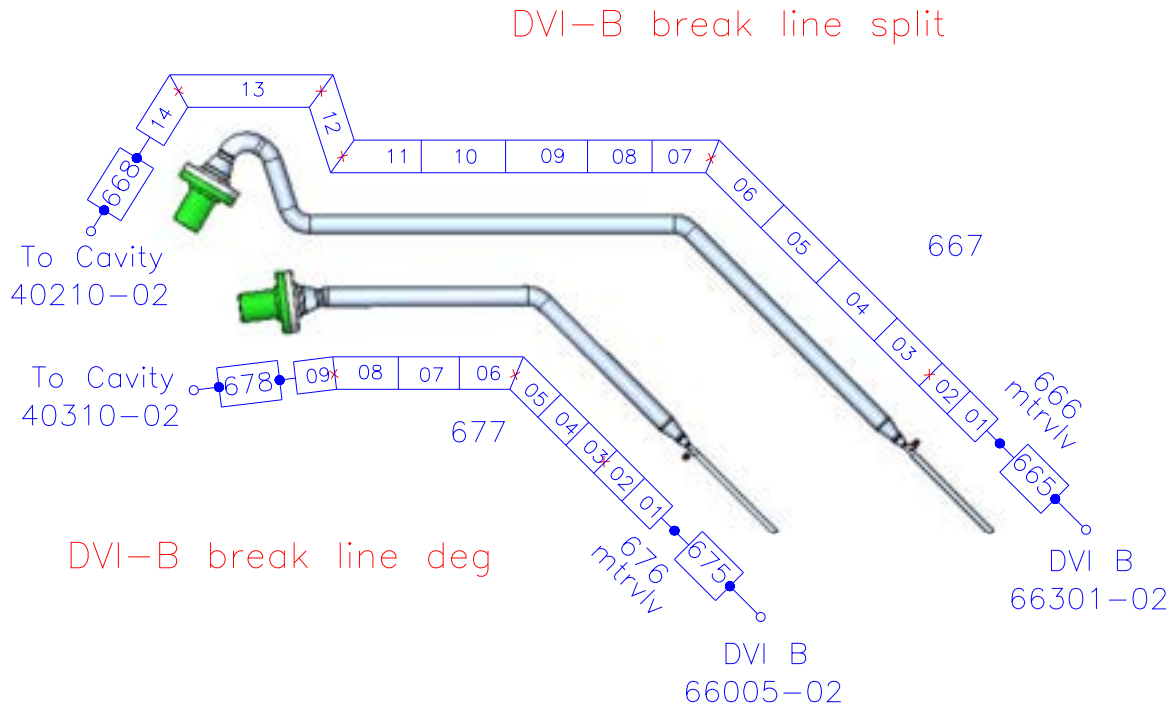

Figure 4.6: SPES3 DVI-B break line nodalization

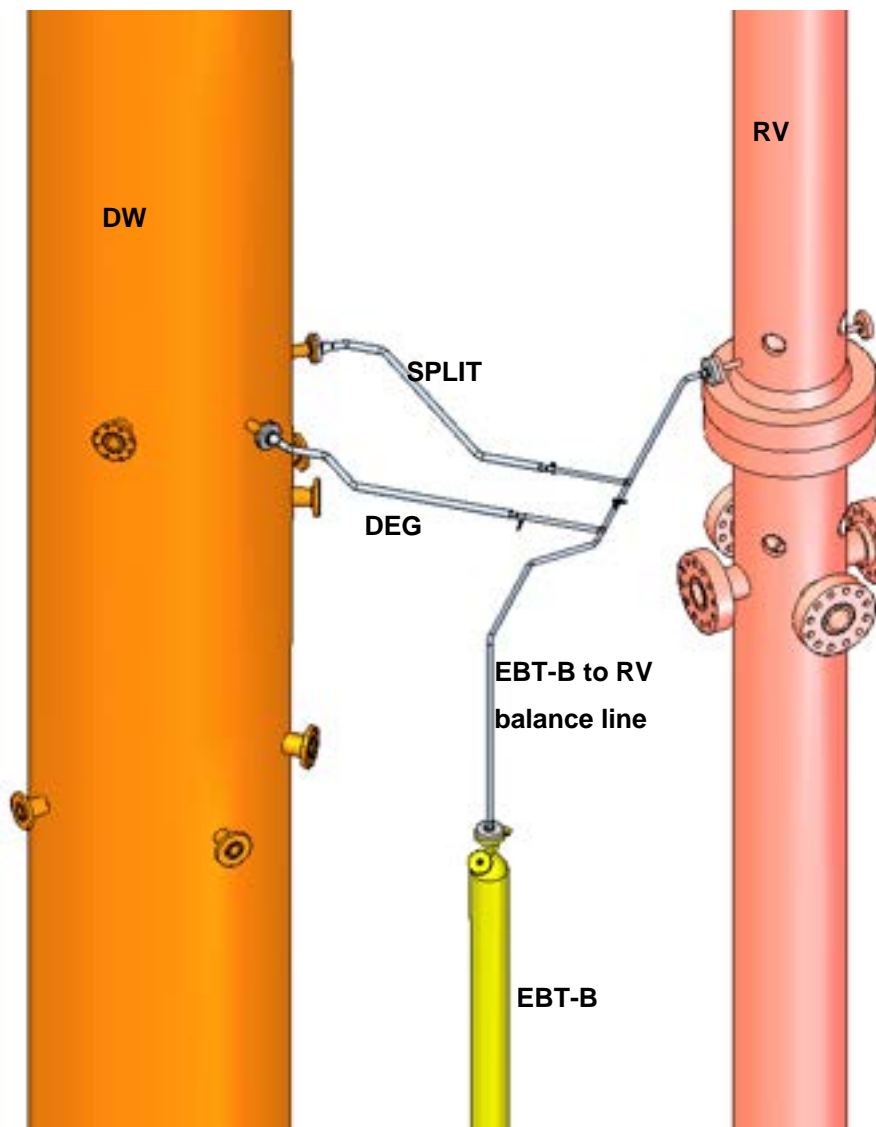

Figure 4.7: SPES3 EBT-B break line system

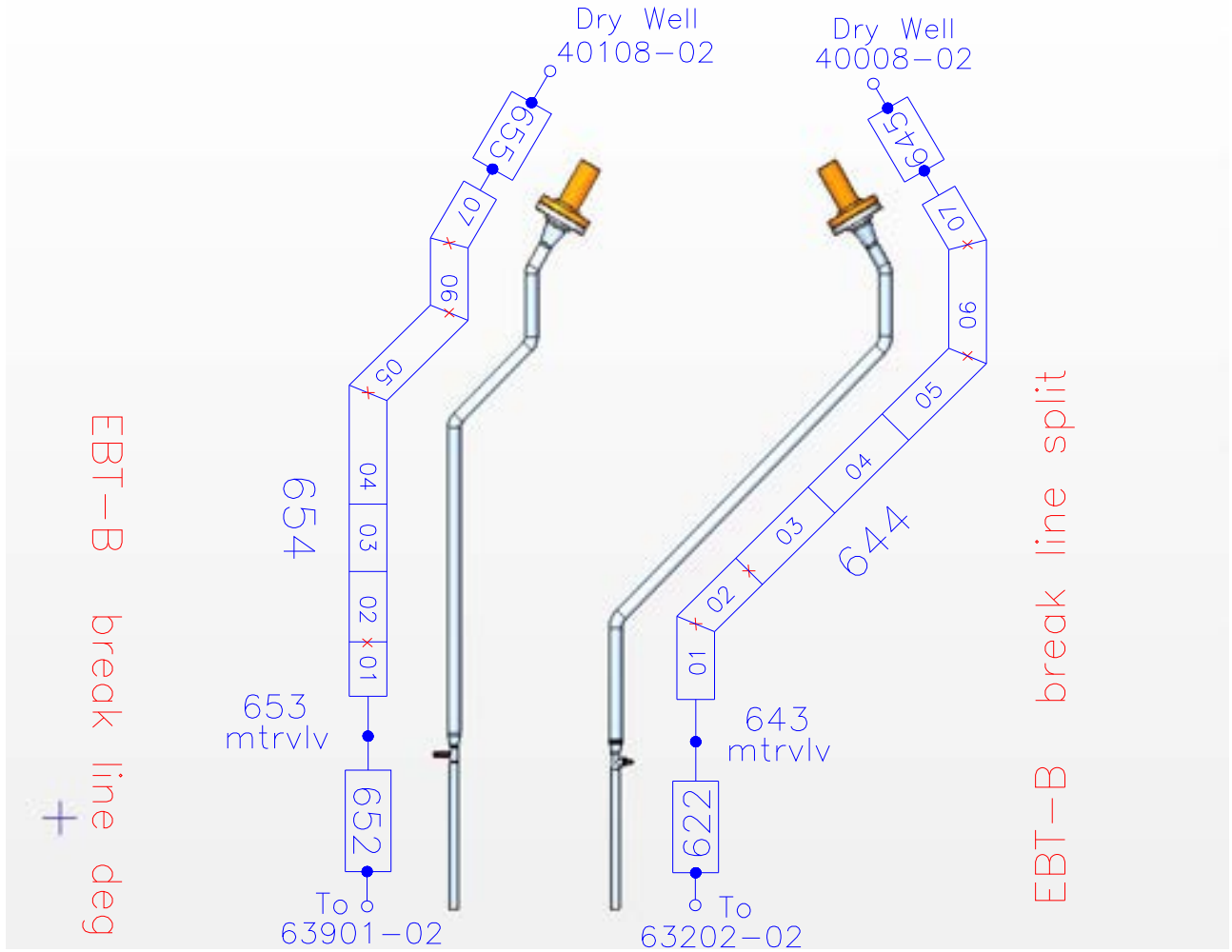

Figure 4.8: SPES3 EBT-B break line nodalization

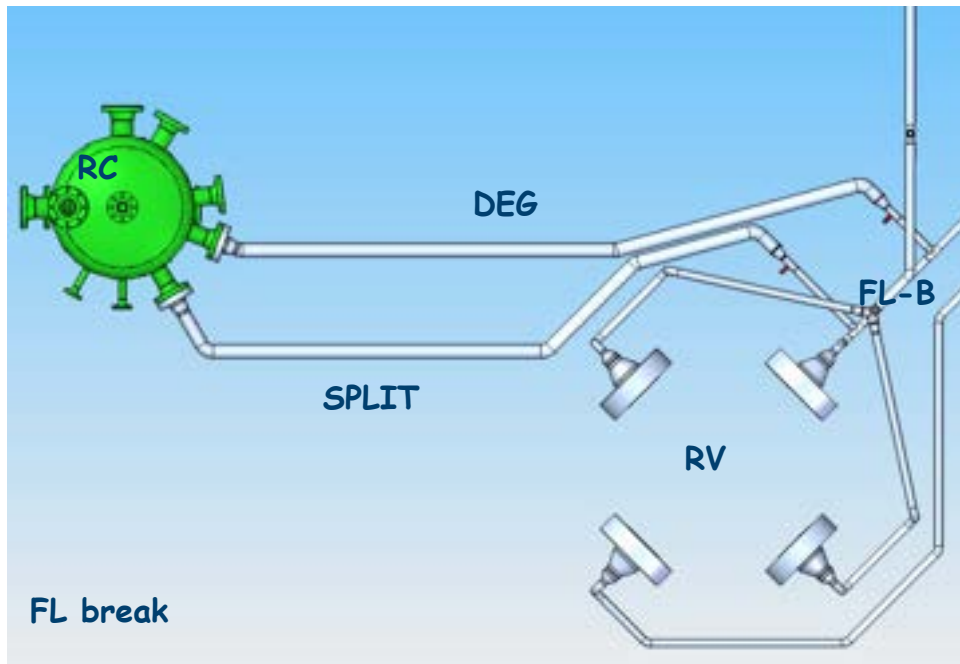

Figure 4.9: SPES3 FL-B break line system

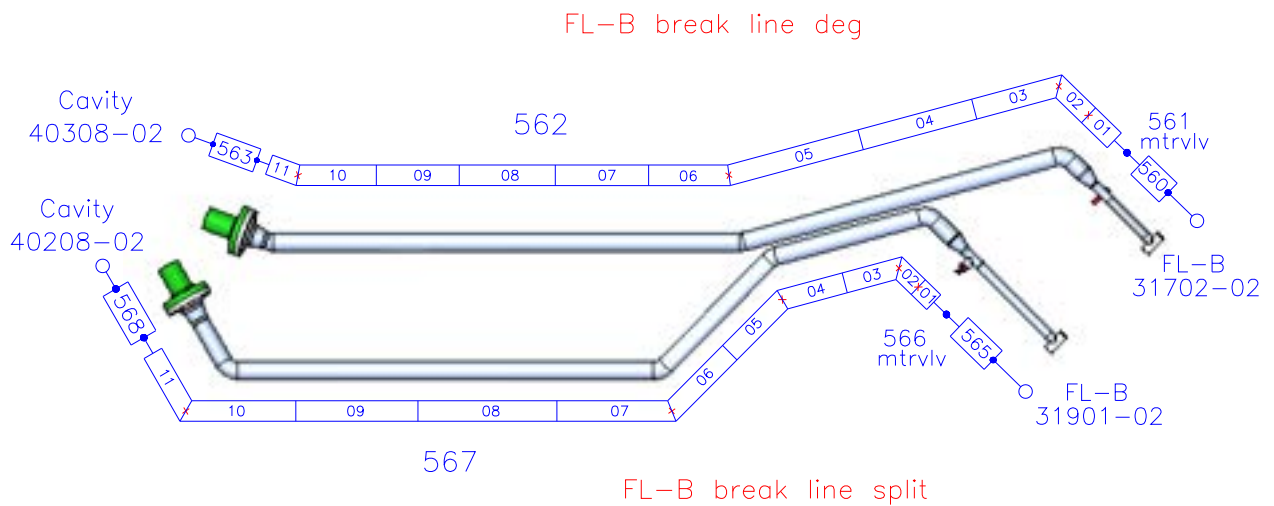

Figure 4.10: SPES3 FL-B break system nodalization

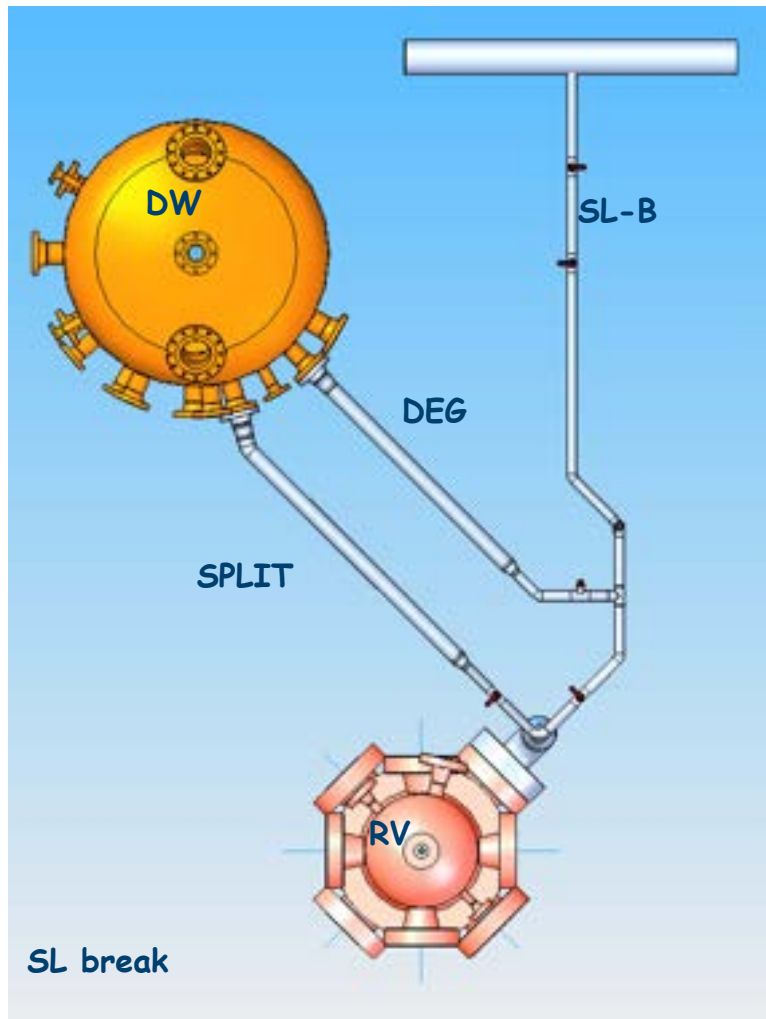

Figure 4.11: SPES3 SL-B break system

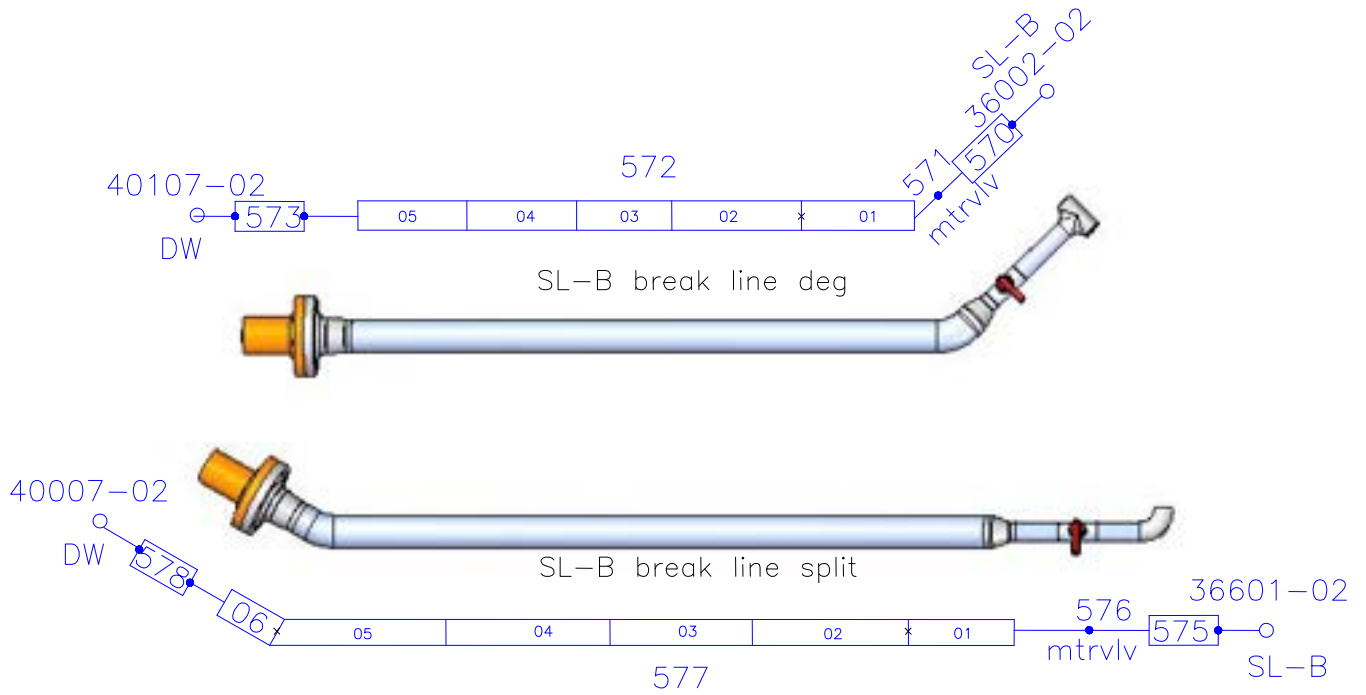

Figure 4.12: SPES3 SL-B break system nodalization

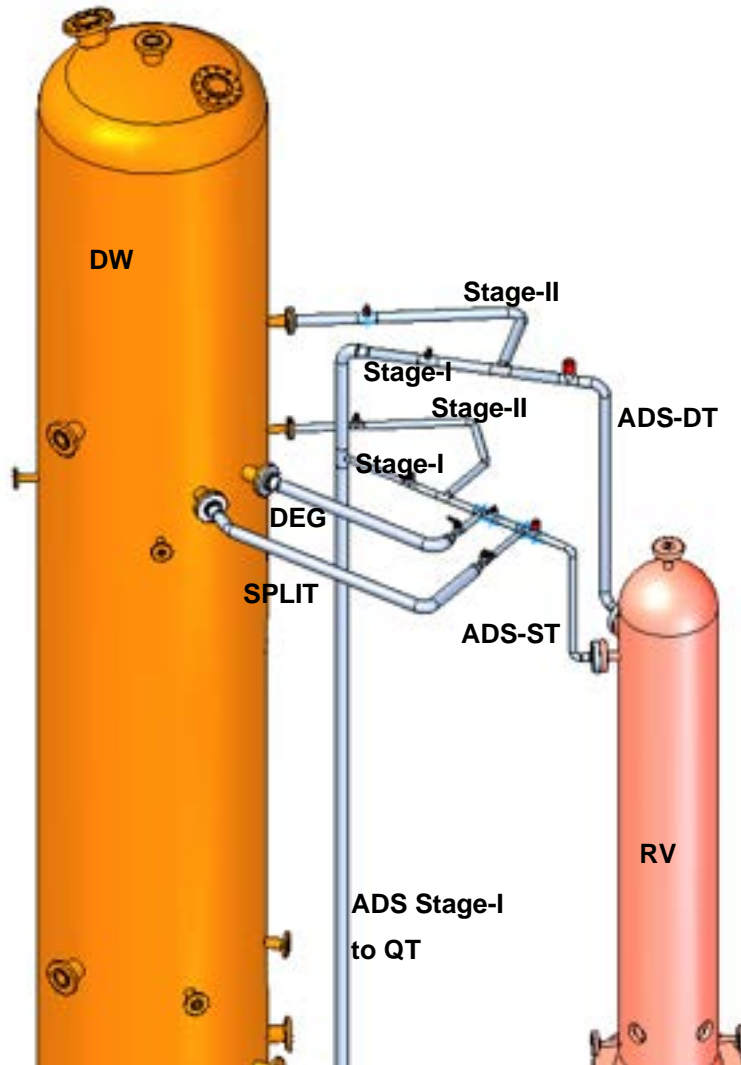

Figure 4.13: SPES3 ADS-ST Stage-I break line system

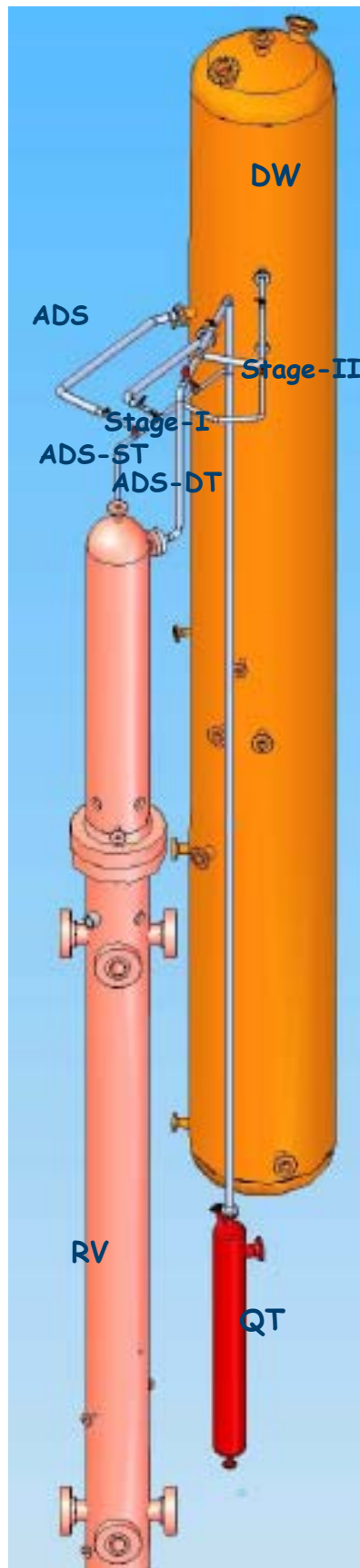

Figure 4.14: SPES3 ADS group of pipes and ADS break lines

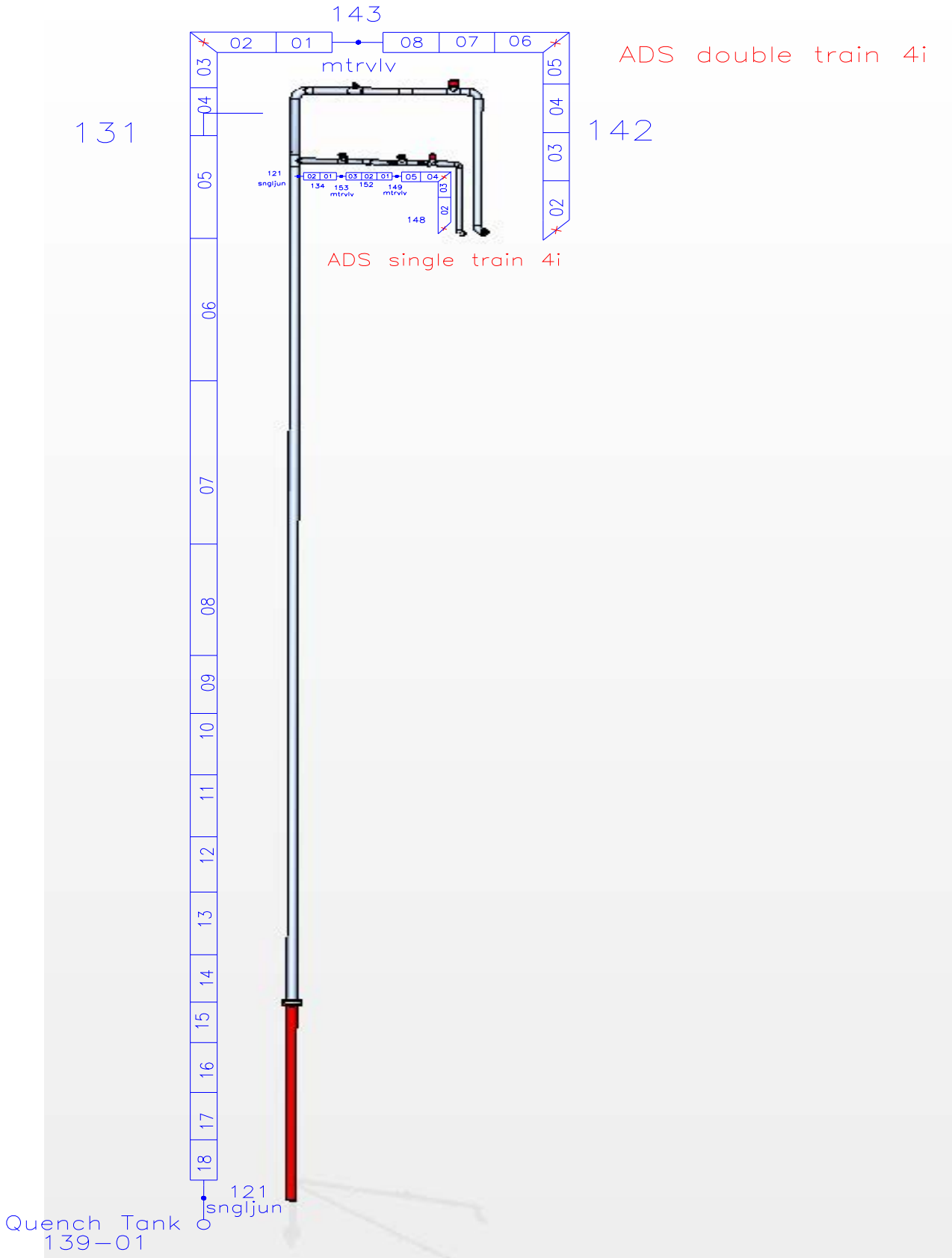

Figure 4.15: SPES3 ADS single and double train nodalization (front view)

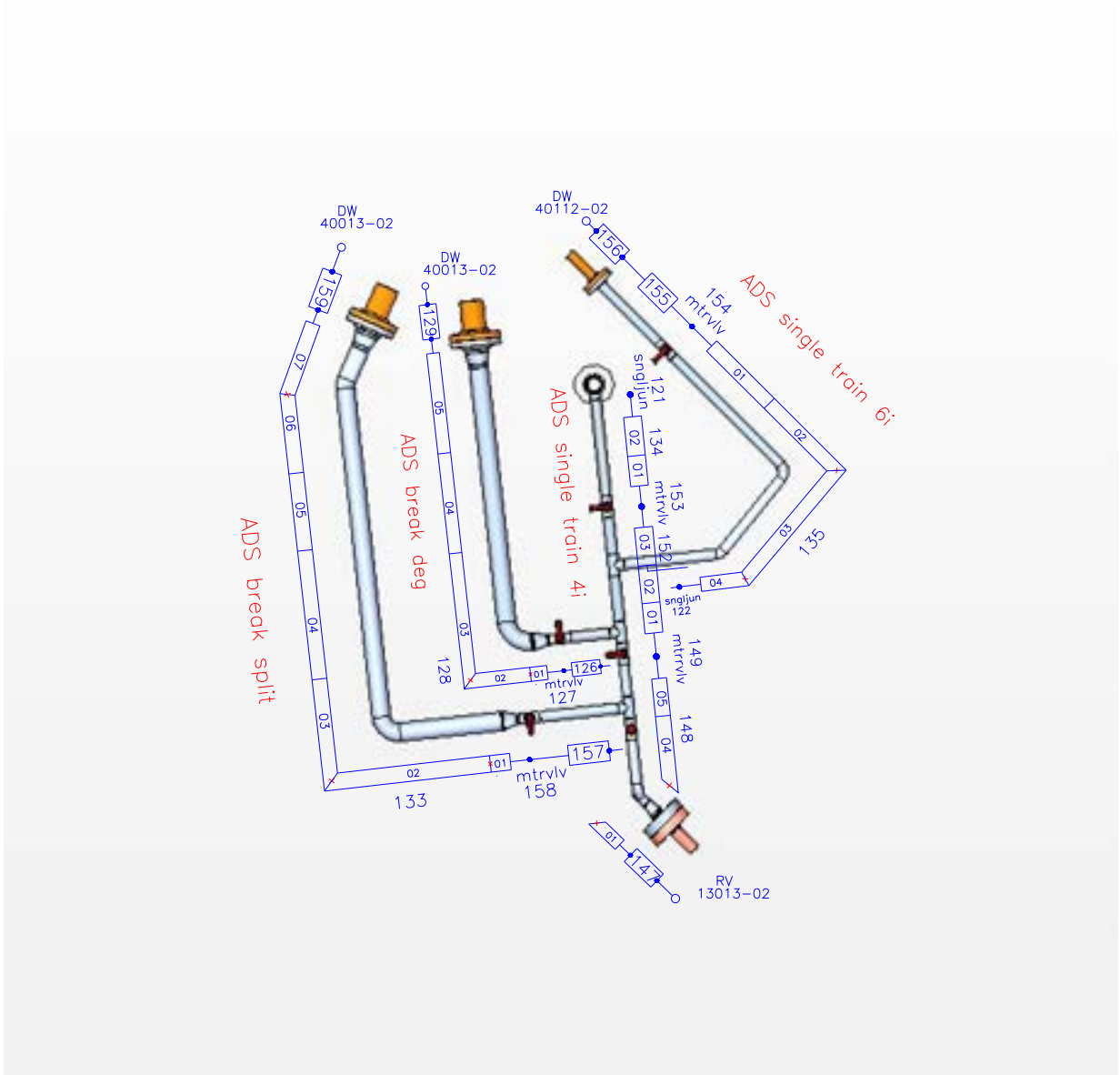

Figure 4.16: SPES3 ADS single train and ADS break line nodalization (top view)

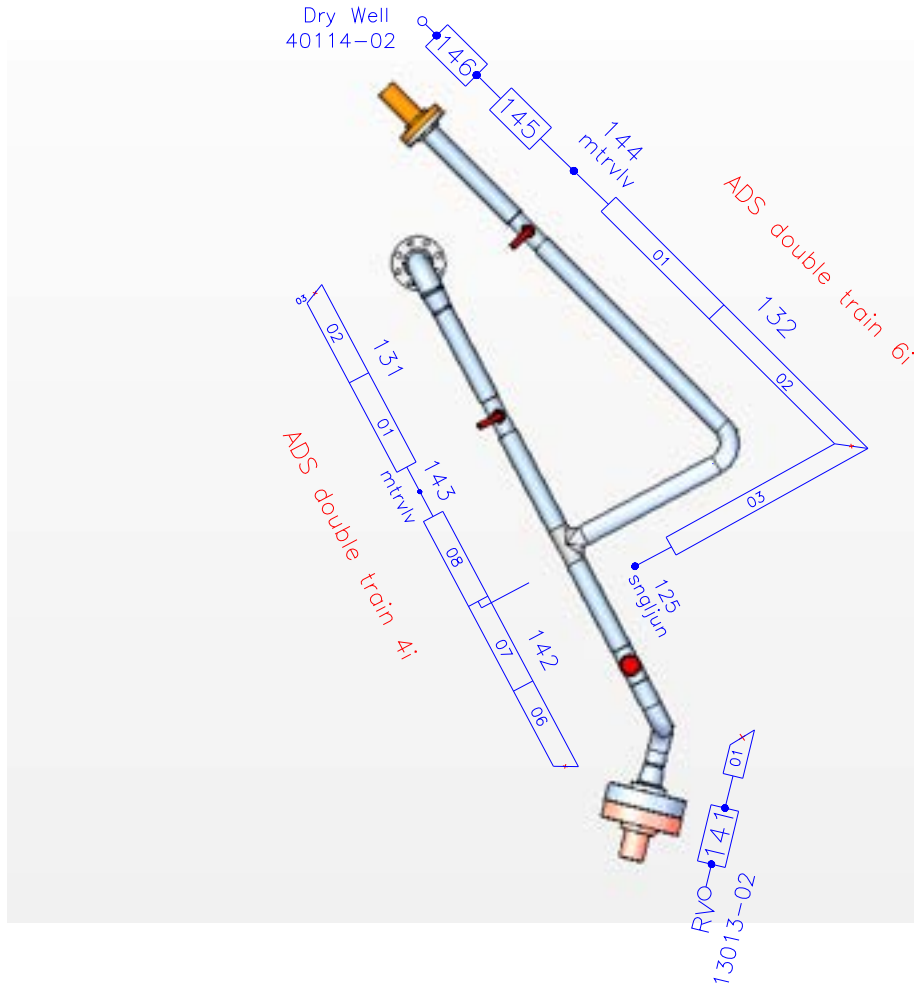

Figure 4.17: SPES3 ADS double train nodalization (top view)

5 VARIABLE RANGE IDENTIFICATION

The aim of the RELAP5 result analyses, related to the break and ADS lines, is to investigate the two-phase thermal-hydraulic conditions in order to identify the variation ranges of the main parameters and to establish suitable criteria to decide where the spool-piece installation is necessary.

In order to investigate the flow conditions in positions where it is foreseen to install instrumentation, a series of monitoring volumes has been defined for each studied line, in particular a volume upstream of the break, the junction representing the break valve, a volume downstream of the break and a volume and the end of the pipe, at the connection with the containment tanks. Such volumes are listed in a proper table for each case.

The variables taken into consideration to analyse the trend of the thermal-hydraulic parameters during the transients are as follows:

- the void fraction and the quality;
- the mass flow;
- the gas and liquid velocities;
- the pressure;
- the gas and liquid temperatures.

The trends of these variables versus time are reported in five graphs for each break line.

A table summarizes the maximum and minimum values of the considered variables.

The evolution of the flow regime in time and space, along the lines, is shown in two tables for the break upstream and downstream position, respectively.

A table points out the minimum and maximum values of the main parameters of the ADS single and double train, Stage-I and Stage-II, upstream and downstream of the valve. Moreover, further graphs shows the void fraction trend in the ADS ST and DT Stage-I.

Each test is described both for break line DEG and for break line SPLIT as follows:

- Five graphs for the main variables upstream of the break;
- A table summarizing the maximum and minimum values of the variables;
- A table for the flow regimes in space and time upstream of the break;
- Five graphs for the main variables downstream of the break;
- A table summarizing the maximum and minimum values of the variables;
- A table for the flow regimes in space and time downstream of the break;
- A table for the maximum and minimum values of mass flowrate and void fraction in the ADS lines.

All the graphs inserted in this document have been realized with a time logarithmic scale.

5.1 DVI BREAK TEST

A Design Basis Event is simulated with a 2 inch equivalent double ended guillotine (DEG) break on the DVI (DVI-B in the facility), but differently from the test matrix specification [1], all the safety systems are available: 3 ADS (ST and DT in SPES3), 2 EBT, 4 EHRS (EHRS-A, B and C in SPES3), 2 LGMS.

5.1.1 DVI DEG break line

The **Errore. L'autoriferimento non è valido per un segnalibro.** describes the nodalization of the DVI DEG BREAK line: one volume upstream of the valve, the junction (valve) that represents the break, nine volumes downstream of the valve and the nozzle before the tank (end of line). The main variables and the flow regimes have been taken in the volumes indicated by “*”.

Table 5.1: List of the RELAP5 volumes for the DVI DEG break

UPSTREAM	VALVE	DOWNSTRAM	END OF LINE
675010000 (*)	676000000	677010000	678010000
		677020000	
		677030000	
		677040000	
		677050000	
		677060000	
		677070000 (*)	
		677080000	
		677090000	

UPSTREAM

The Figure 5.1, Figure 5.2, Figure 5.3, Figure 5.4 and Figure 5.5 represent the mass flowrate, the liquid and gas velocities, the pressure, the liquid and gas temperatures, the void fraction and the quality of the volume 675010000 upstream of the break in the DVI DEG line,

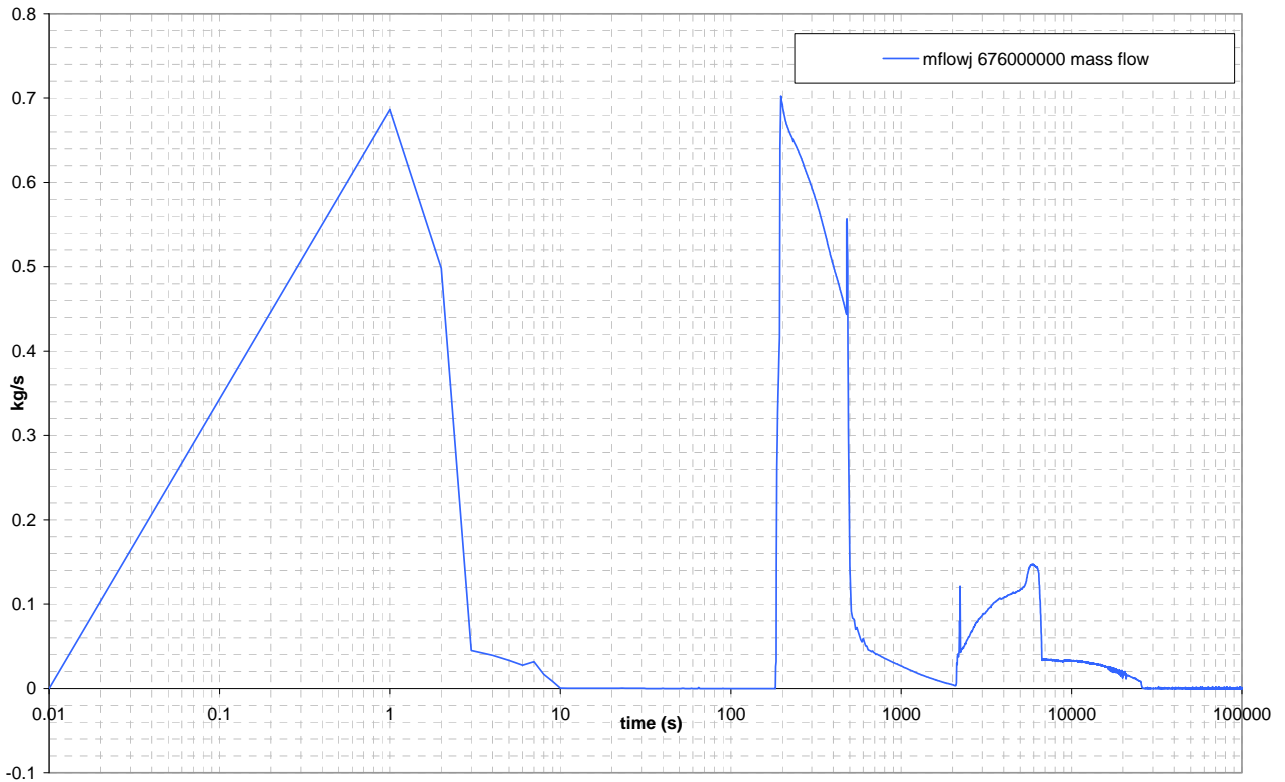

Figure 5.1: DVI DEG BREAK LINE Mass flowrate

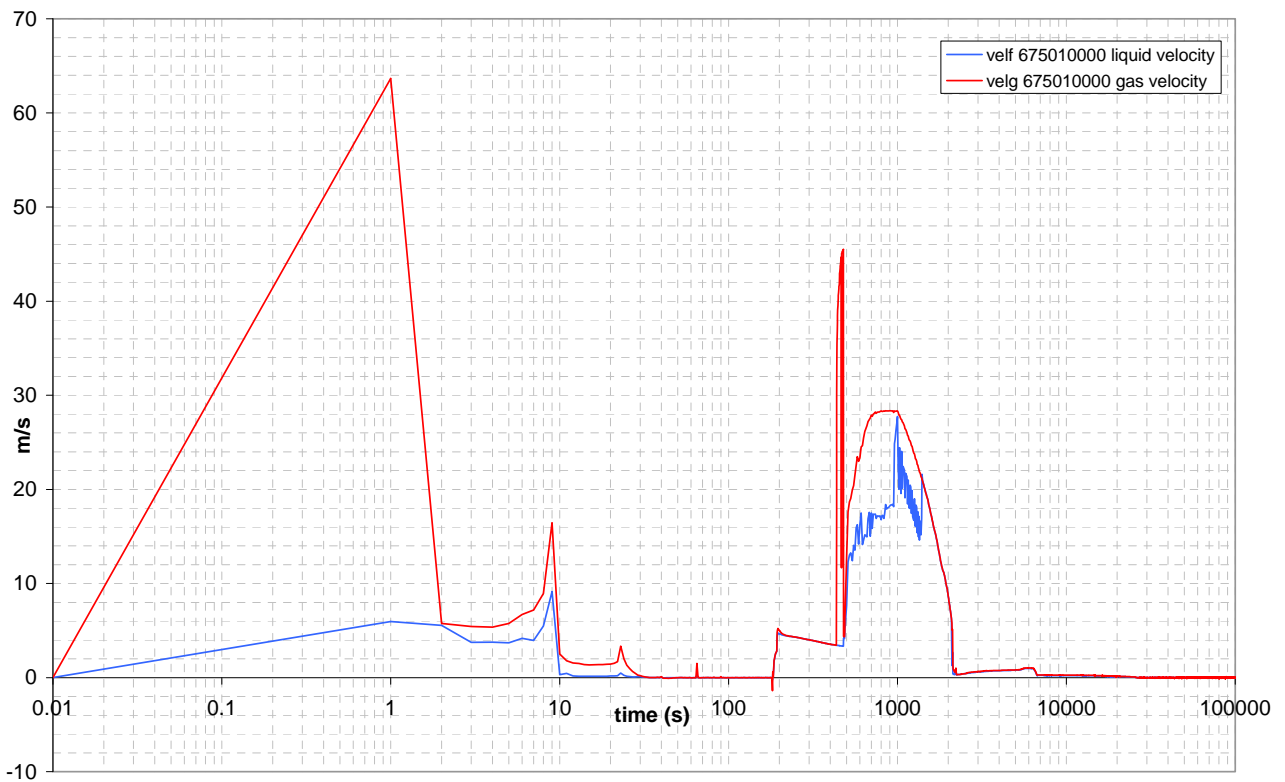

Figure 5.2: DVI DEG BREAK LINE liquid and gas velocities UPSTREAM

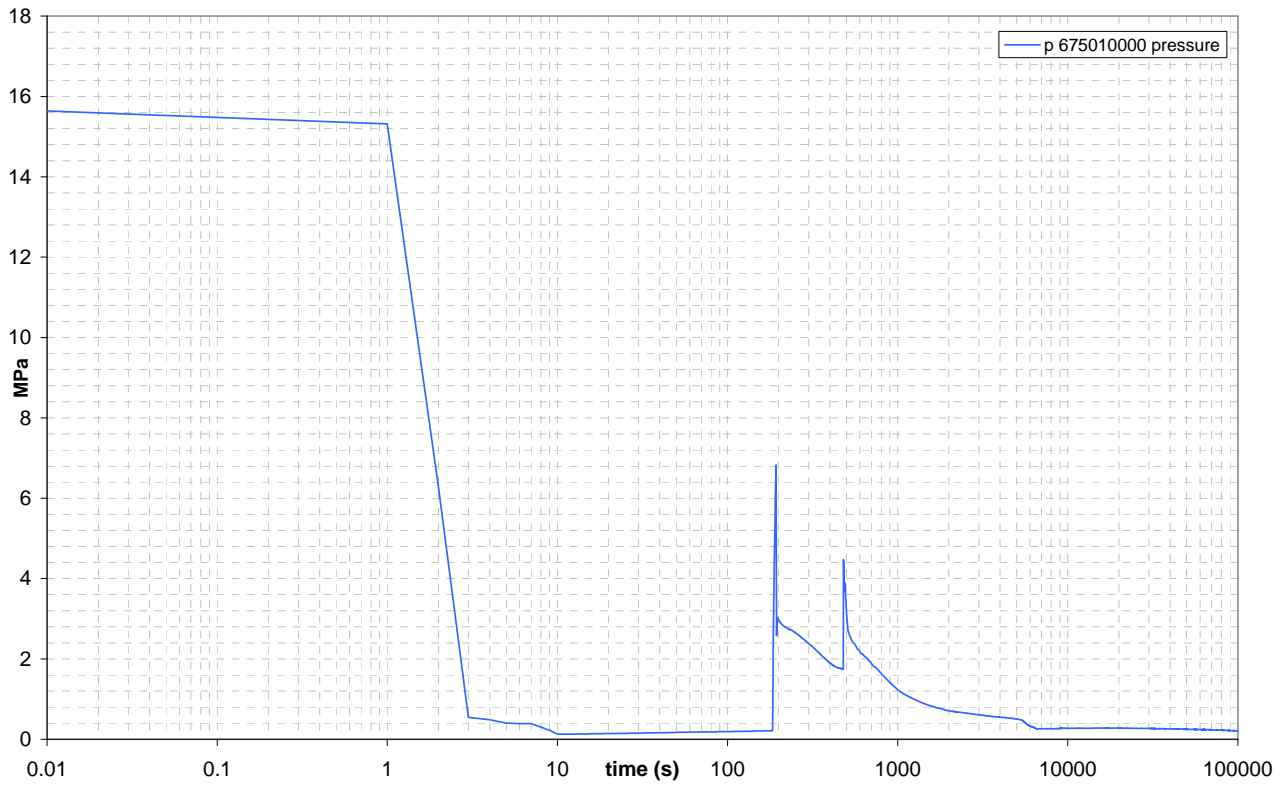

Figure 5.3: DVI DEG BREAK LINE pressure UPSTREAM

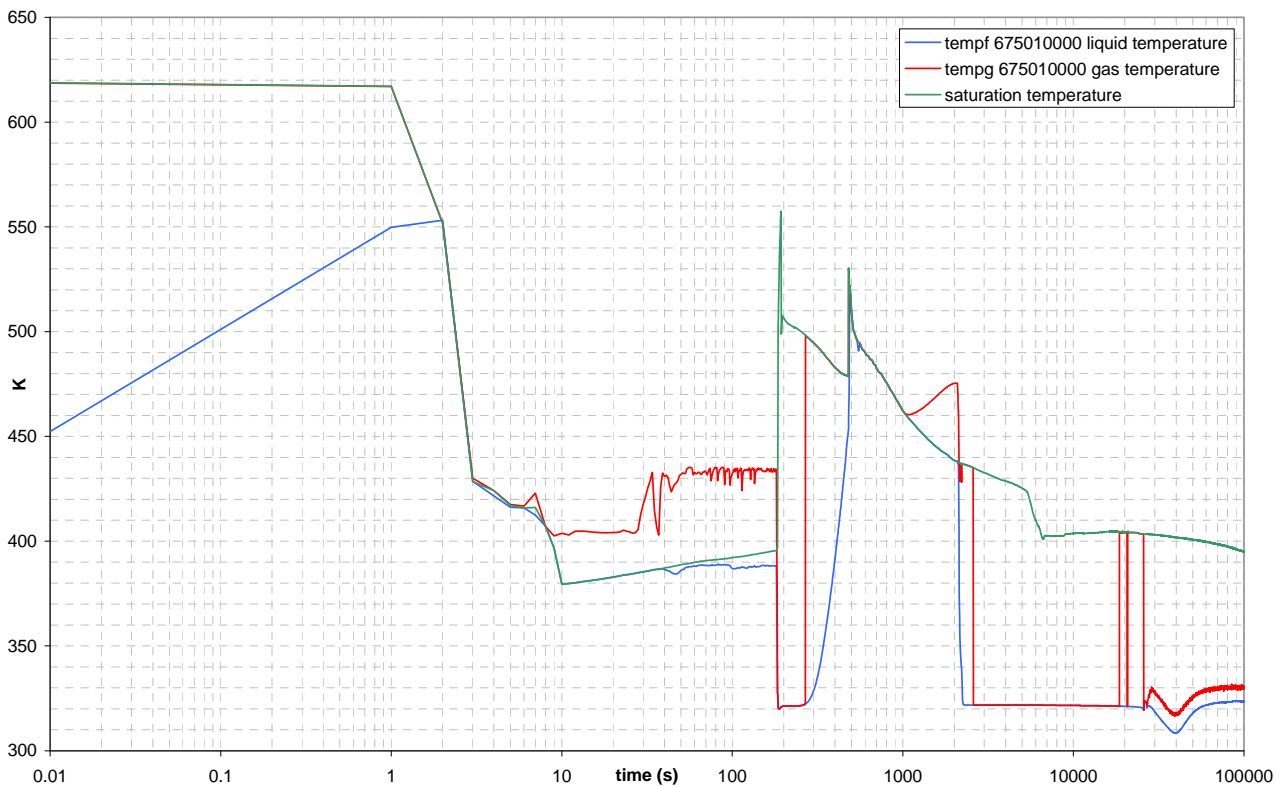

Figure 5.4: DVI DEG BREAK LINE liquid and gas temperatures UPSTREAM

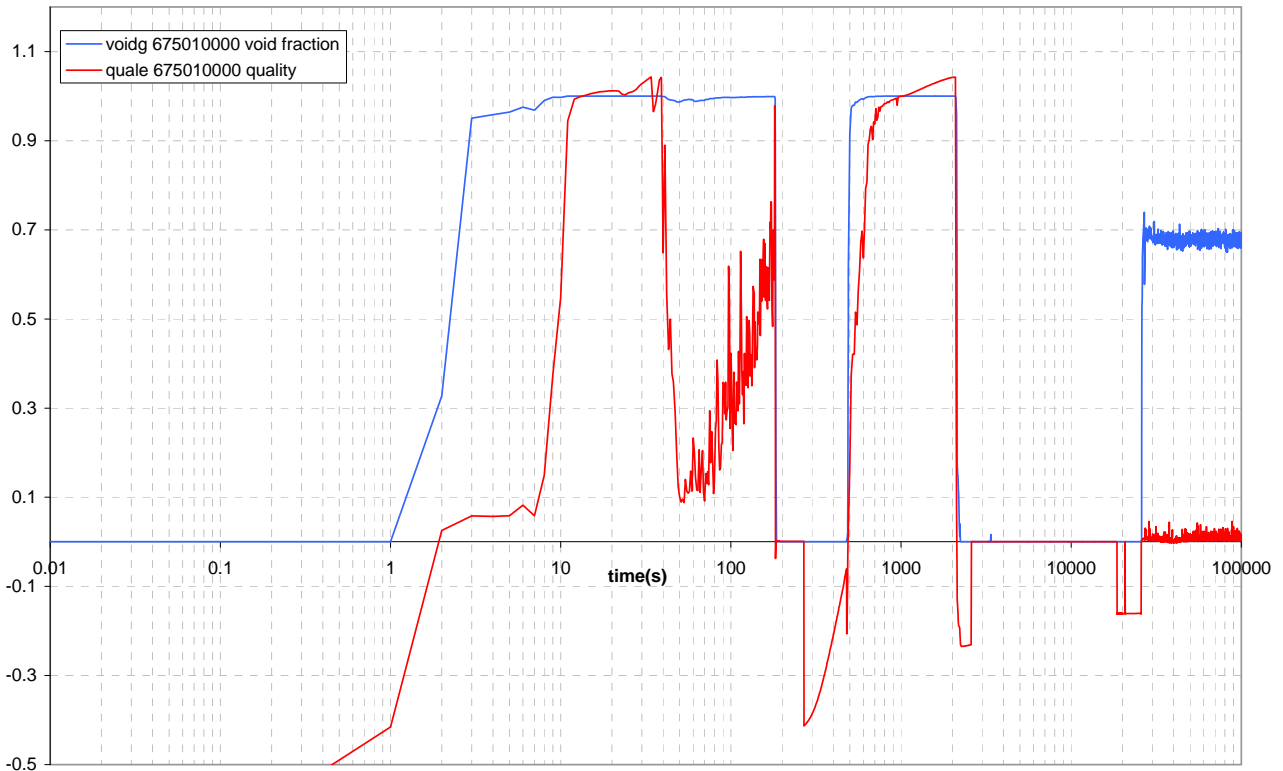

Figure 5.5: DVI DEG BREAK LINE void fraction and quality UPSTREAM

Table 5.2: Maximum and minimum values of the main variables in the
DVI DEG break line upstream the valve

DVI DEG break line UPSTREAM		MIN	MAX
void fraction		0	1
volume equilibrium quality		-0.9076	1.0429
mass flowrate	kg/s	-0.00047	0.7023
liquid velocity	m/s	-0.2459	27.7336
gas velocity	m/s	-1.3802	63.6599
liquid temperature	K	308.4040	553.2080
gas temperature	K	316.4240	618.6600
pressure	MPa	0.1266	15.6391

The Table 5.2 shows the minimum and maximum values of void fraction, quality, mass flowrate, liquid and gas velocities, liquid and gas temperatures, pressure during the transient, upstream of the break.

DOWNSTREAM

The Figure 5.6, Figure 5.7, Figure 5.8 and Figure 5.9 represent the liquid and gas velocities, the pressure, the liquid and gas temperatures, the void fraction and the quality in the volume 677070000, downstream of the break in the DVI DEG line. Figure 5.10 shows the volumetric flowrate calculated using the area of the pipe, the void fraction, the gas and liquid velocities.

The mass flowrate is not shown because it is the same downstream and upstream of the break.

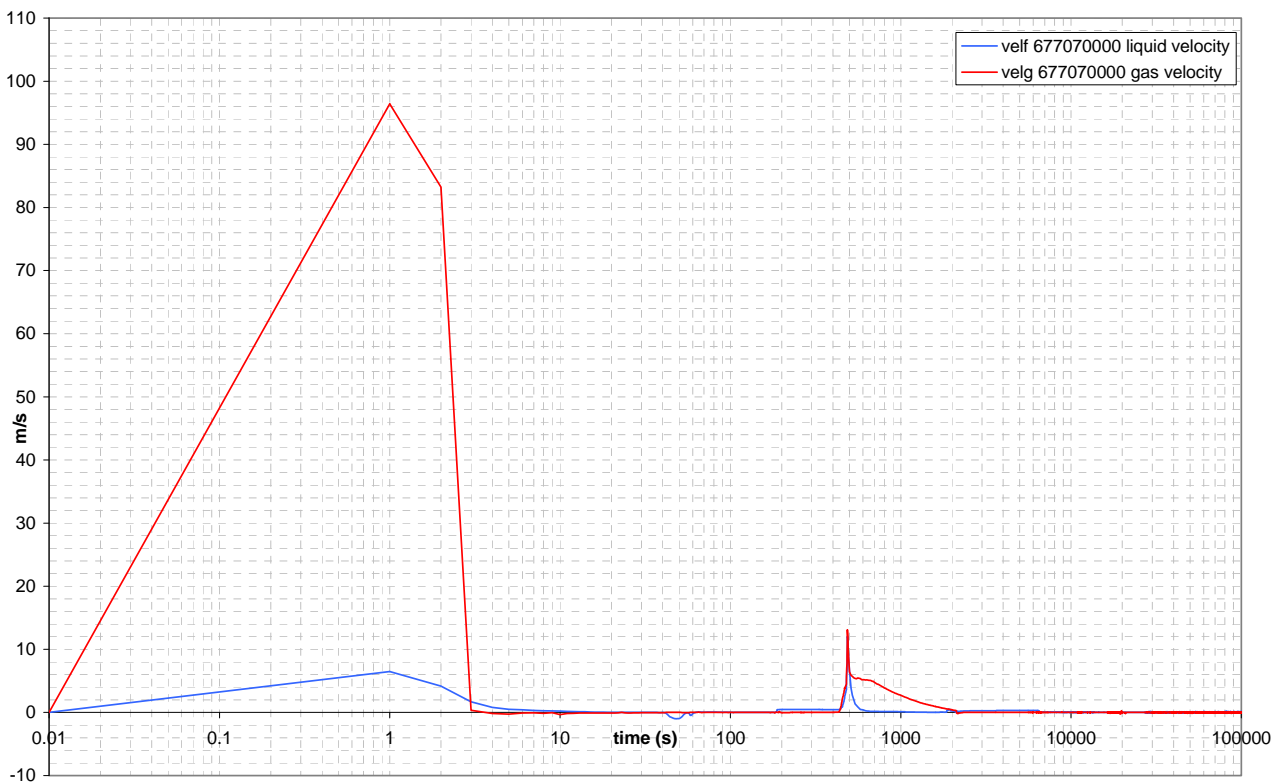

Figure 5.6: DVI DEG BREAK LINE liquid and gas velocities DOWNSTREAM

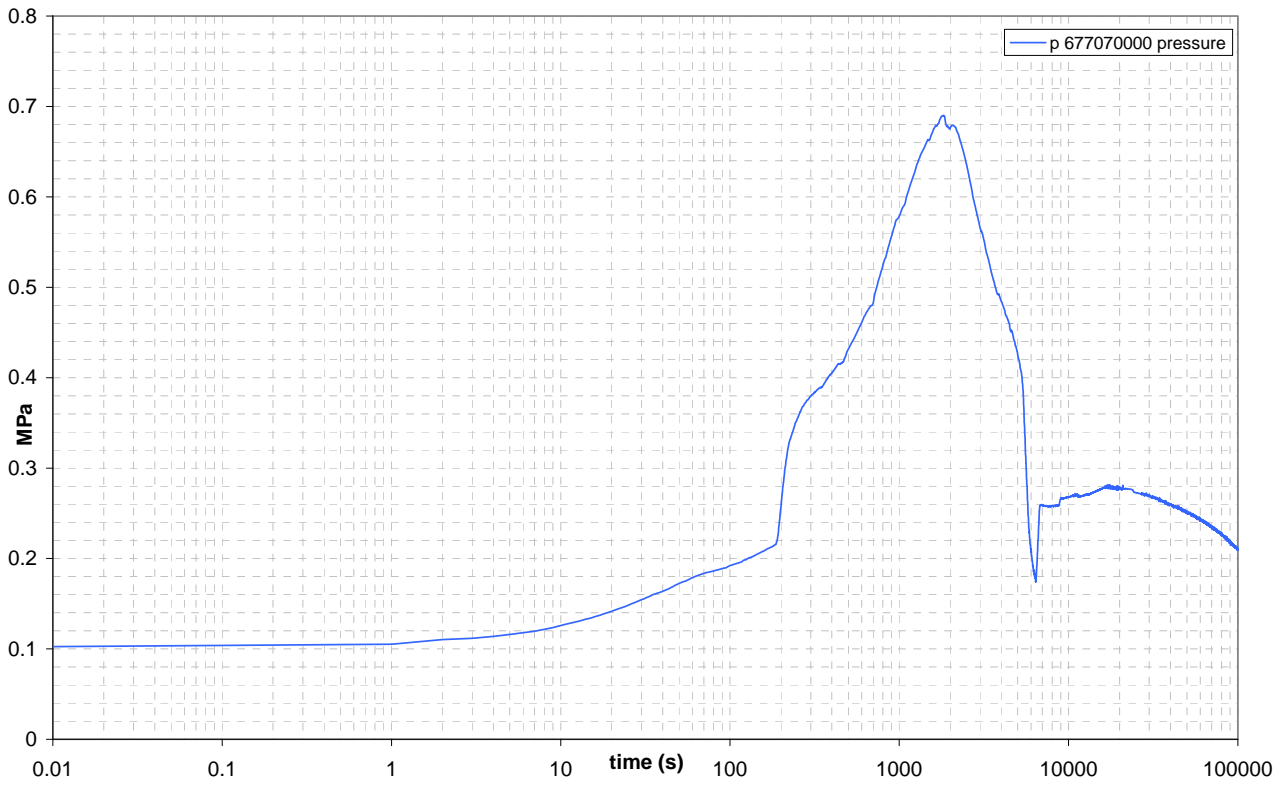

Figure 5.7: DVI DEG BREAK LINE pressure DOWNSTREAM

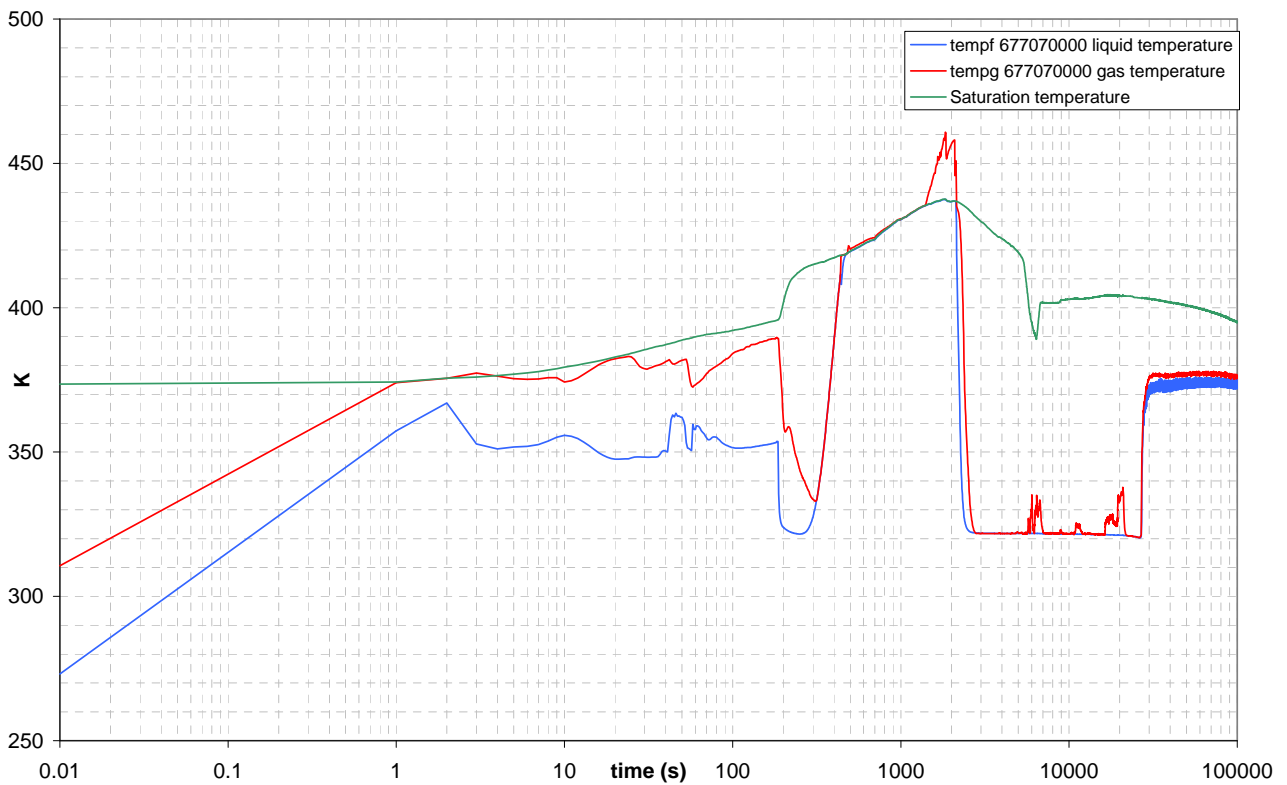

Figure 5.8: DVI DEG BREAK LINE liquid and gas temperatures DOWNSTREAM

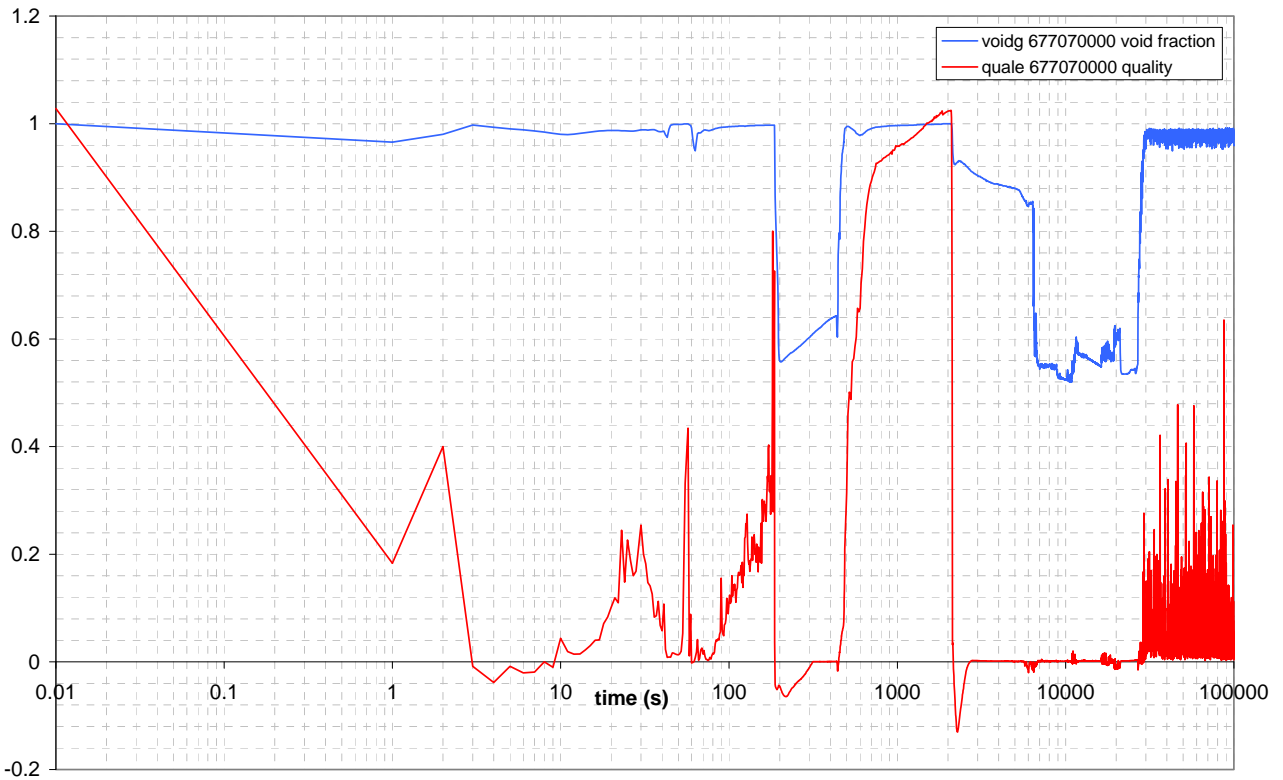

Figure 5.9: DVI DEG BREAK LINE void fraction and quality DOWNSTREAM

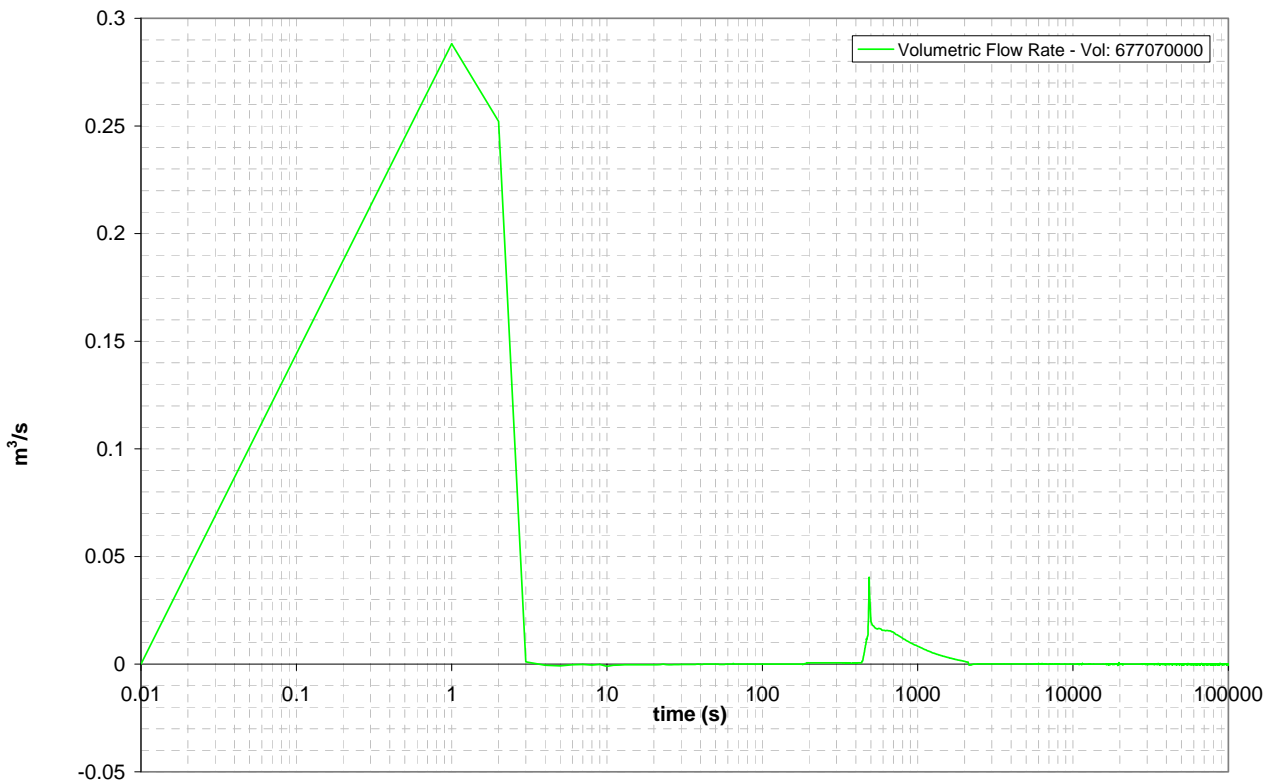

Figure 5.10: DVI DEG BREAK LINE volumetric flowrate DOWNSTREAM

The Table 5.3 shows the minimum and maximum values of void fraction, quality, mass flowrate, liquid and gas velocities, liquid and gas temperatures, pressure and volumetric flowrate during the transient, downstream of the break.

Table 5.3: Maximum and minimum values of the main variables in the DVI DEG break line downstream of the break

DVI DEG break line DOWNSTREAM		MIN	MAX
void fraction		0.5198	1
volume equilibrium quality		-0.1303	1.028
mass flowrate	kg/s	-0.00047	0.70233
liquid velocity	m/s	-0.989	12.008
gas velocity	m/s	-0.360	93.778
liquid temperature	K	320.28	437.50
gas temperature	K	320.35	460.84
pressure	MPa	0.1025	0.6902
volumetric flowrate	m ³ /s	-0.001	0.2882

The Table 5.4 describes the flow regimes in the volume before the break and in some volumes after the break. The time step changes only when there is a modification in the flow regime. The volumes highlighted in red indicate the monitoring points.

FLOW REGIMES

Table 5.4: Flow regimes function of monitoring volumes and time – DVI DEG LINE

Time	675010	677010	677030	677050	677070	677090	678010
0	BBY	CHF MPR	CHF MPR	CHF MPR	CHF MPR	CHF MPR	CHF MPR
1	BBY	ANM	ANM	ANM	ANM	ANM	ANM
2	HST	ANM	ANM	ANM	ANM	ANM	HST
7	HST	ANM	HST	HST	HST	HST	HST
54	HST	HST	HST	HST	HST	HST	HST
56	HST	HST	HST	HST	HST	HST	CHF MPR
184	HST	HST	HST	HST	HST	HST	HST
185	BBY	HST	HST	HST	HST	HST	HST
437	BBY	BBY	HST	HST	HST	HST	HST
454	BBY	SLG	HST	HST	HST	HST	HST
487	BBY	ANM	HST	HST	HST	HST	HST
488	HST	ANM	HST	HST	HST	HST	HST
490	SLG	ANM	HST	HST	HST	HST	HST
810	SLG	ANM	HST	HST	HST	HST	HST
1020	CHF MPR	ANM	HST	HST	HST	HST	HST
1390	HST	ANM	HST	HST	HST	HST	HST
1850	HST	HST	HST	HST	HST	HST	HST
1860	HST	CHF MPR	CHF MPR	CHF MPR	HST	HST	HST
1910	HST	CHF MPR	CHF MPR	CHF MPR	CHF MPR	HST	HST
1920	HST	CHF MPR	CHF MPR	CHF MPR	CHF MPR	CHF MPR	HST
1940	HST	CHF MPR	CHF MPR	CHF MPR	CHF MPR	CHF MPR	CHF MPR
2090	HST	CHF MPR	CHF MPR	CHF MPR	CHF MPR	HST	HST
2180	HST	HST	HST	HST	HST	HST	HST
2190	BBY	HST	HST	HST	HST	HST	HST
2200	BBY	BBY	HST	HST	HST	HST	HST
2210	BBY	HST	HST	HST	HST	HST	HST
2220	BBY	BBY	HST	HST	HST	HST	HST
2230	BBY	HST	HST	HST	HST	HST	HST
6690	BBY	BBY	HST	HST	HST	HST	HST
25790	BBY	HST	HST	HST	HST	HST	HST
99990	HST	HST	HST	HST	HST	HST	HST

5.1.1.1 Synthesis of achievements for the DVI DEG break

As indicated by Figure 5.3 and Table 5.2, pressure upstream of the break is very high (15.6 MPa), at least at the beginning of the transient, whereas pressure downstream of the break reaches a maximum 0.7 MPa, as shown in Figure 5.7. Therefore the installation of an eventual spool piece is suggested downstream of the break.

The void fraction varies between 0 and 1 as indicated in Figure 5.9 and Table 5.3 and the mass flowrate is appreciable as indicated in Figure 5.1 and Table 5.2. Anyway, the mass flowrate through the DEG line is due to water coming from the EBT and LGSM safety systems [4] and such single-phase mass flows are measured by orifices in the related injection lines.

This avoids the need to install a spool piece on the DVI DEG break line.

For the DVI DEG break line, a Venturi meter will be installed upstream of the break.

5.1.2 DVI SPLIT break line

The **Errore. L'autoriferimento non è valido per un segnalibro.** describes the nodalization of the DVI SPLIT BREAK line: one volume upstream the valve, the junction (valve) that represents the break, fourteen volumes downstream of the valve and the nozzle before the tank (end of line). The main variables and the flow regimes have been taken in the volumes indicated by “*”.

Table 5.5: Description of the volumes for the DVI SPLIT break

UPSTREAM	MOTOR VALVE	DOWNSTRAM	END OF LINE
665010000 (*)	666000000	667010000	668010000
		667020000	
		667030000	
		667040000	
		667050000	
		667060000	
		667070000	
		667080000	
		667090000 (*)	
		667100000	
		667110000	
		667120000	
		667130000	
		667140000	

UPSTREAM

The Figure 5.11, Figure 5.12, Figure 5.13, Figure 5.14 and Figure 5.15 represent the mass flowrate, the liquid and gas velocities, the pressure, the liquid and gas temperatures, the void fraction and the quality of the volume 665010000 upstream of the break in the DVI SPLIT line.

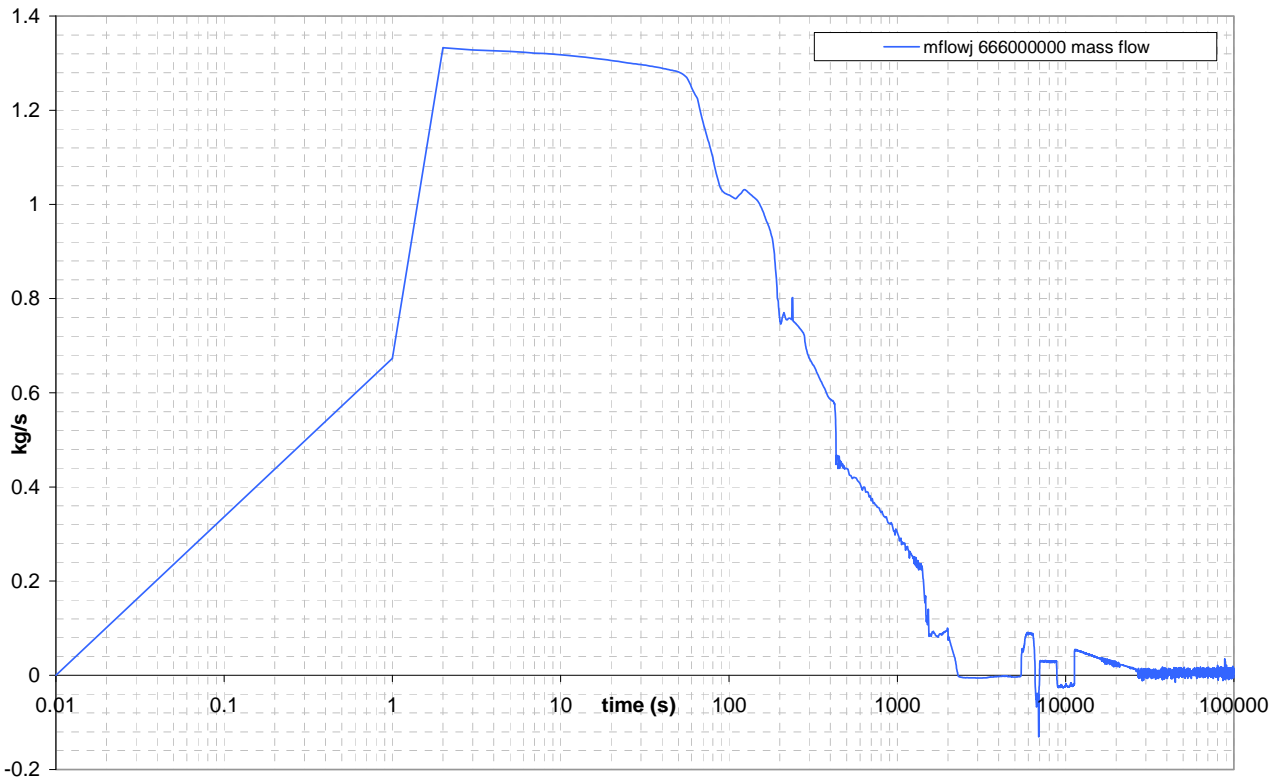

Figure 5.11: DVI SPLIT BREAK LINE mass flowrate

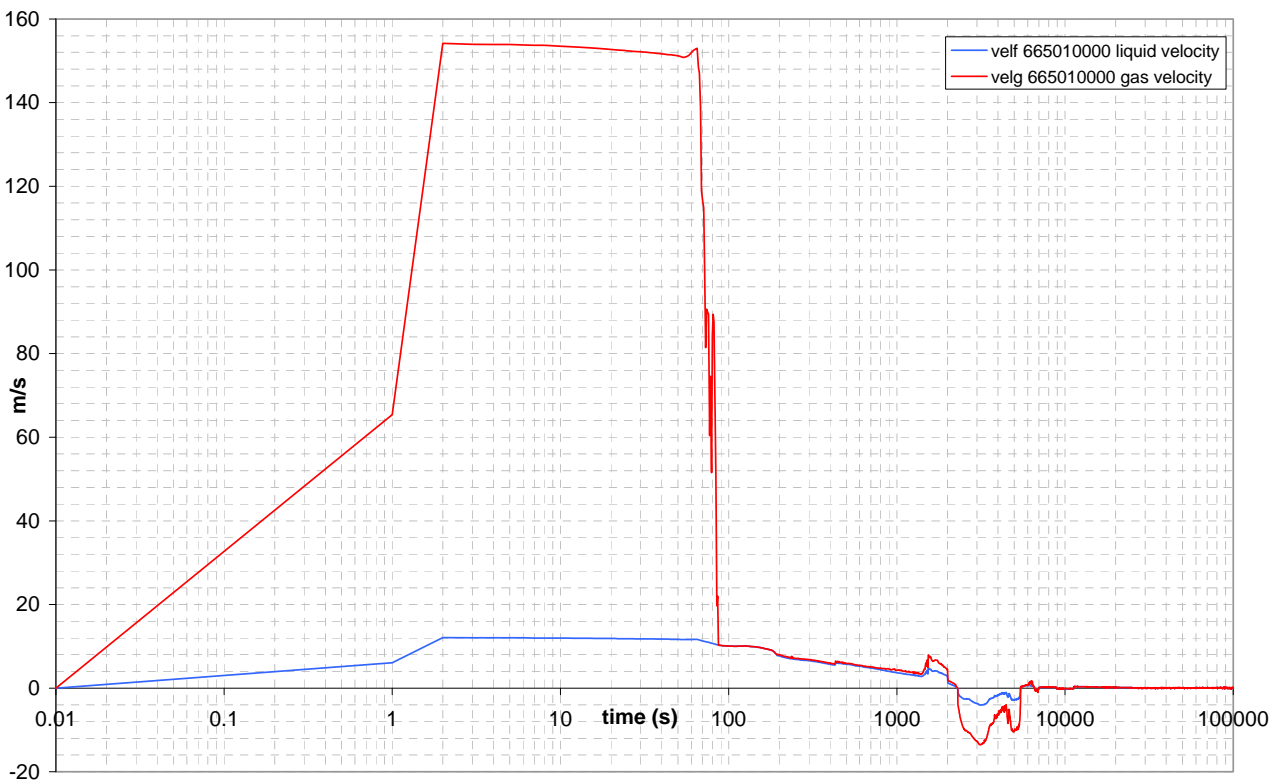

Figure 5.12: DVI SPLIT BREAK LINE liquid and gas velocities UPSTREAM

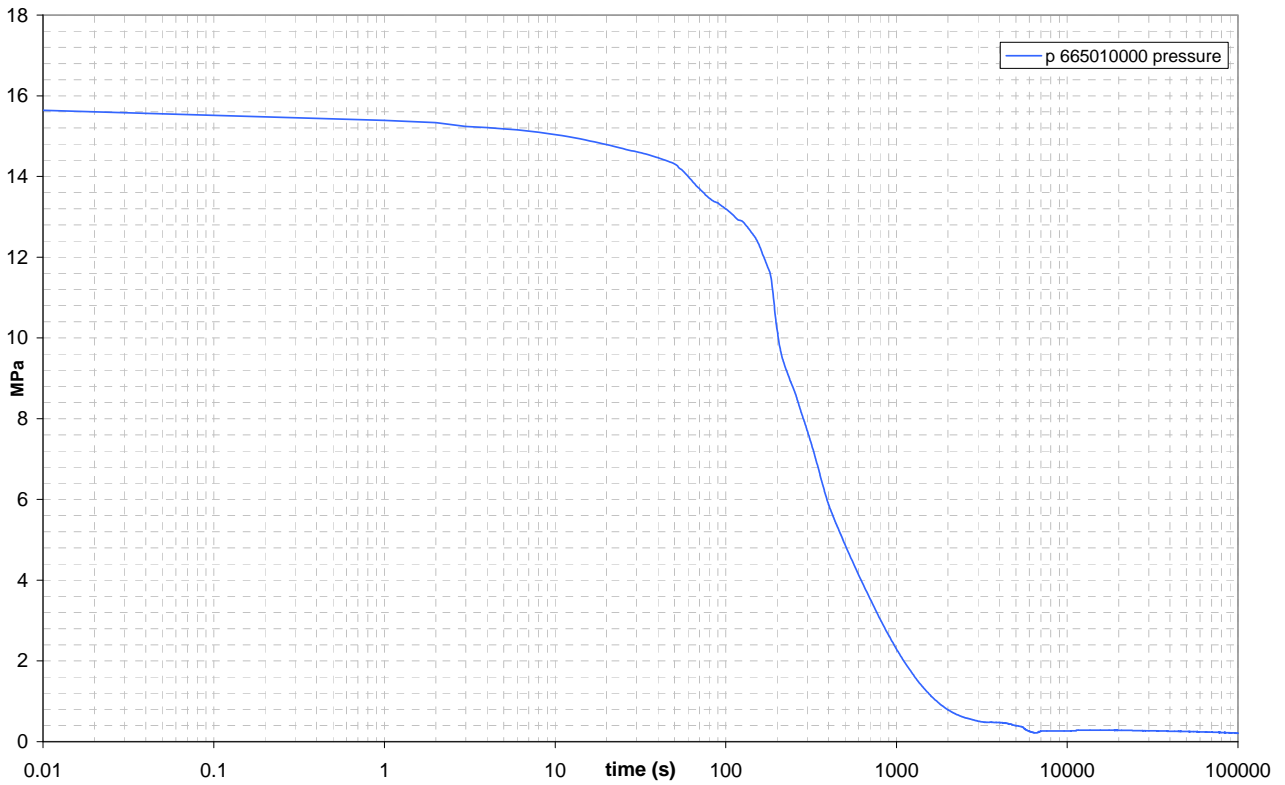

Figure 5.13: DVI SPLIT BREAK LINE pressure UPSTREAM

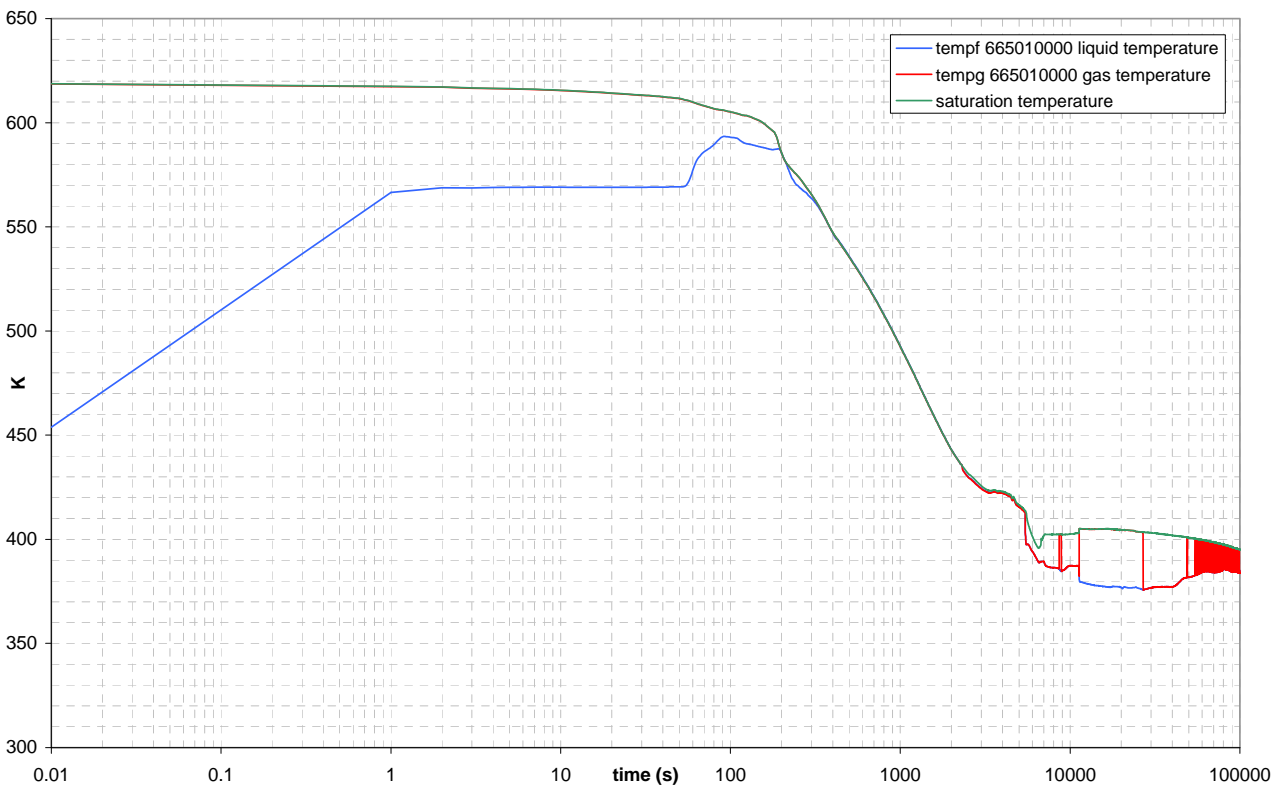

Figure 5.14: DVI SPLIT BREAK LINE liquid and gas temperatures UPSTREAM

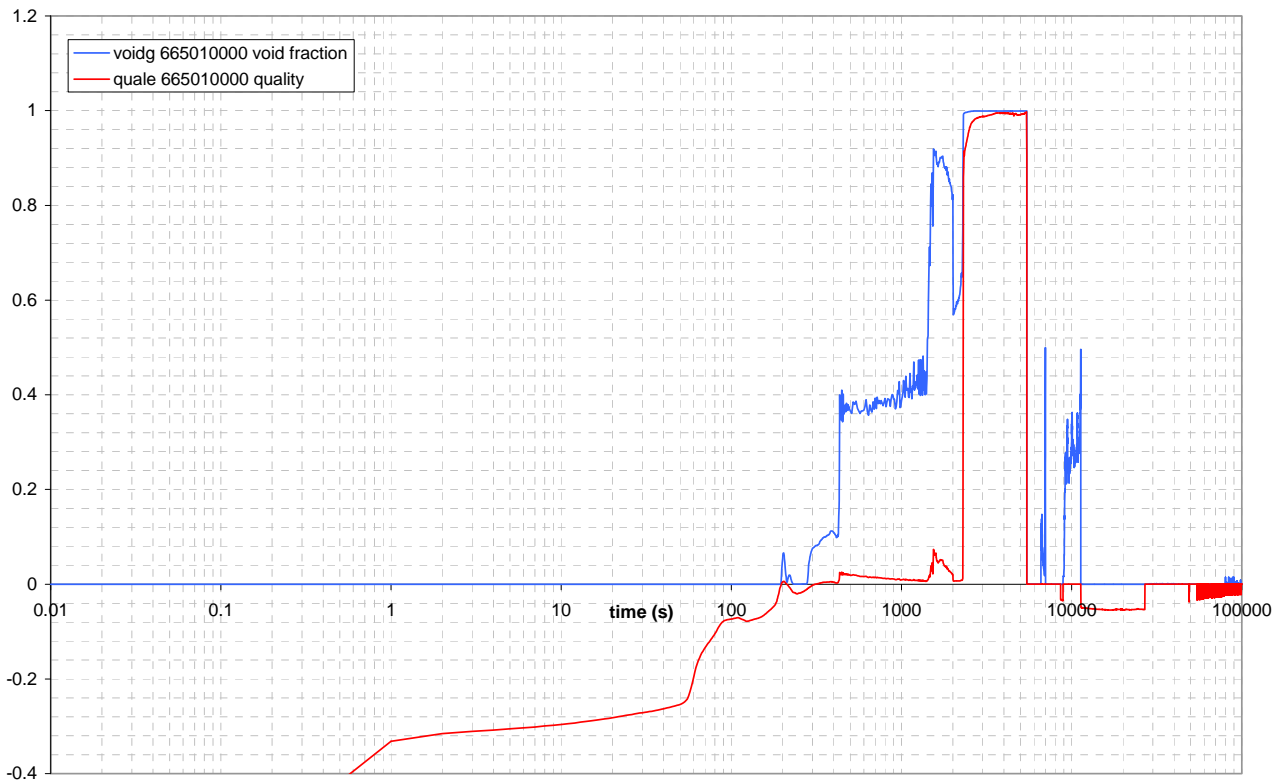

Figure 5.15: DVI SPLIT BREAK LINE void fraction and quality UPSTREAM

Table 5.6: Maximum and minimum values of the main variables in the DVI SPLIT break line upstream the break

DVI SPLIT break line UPSTREAM		MIN	MAX
void fraction		0	0.9994
volume equilibrium quality		-0.9012	0.9975
mass flowrate	kg/s	-0.1308	1.3328
liquid velocity	m/s	-4.0312	12.0997
gas velocity	m/s	-13.5510	154.1660
liquid temperature	K	375.5650	593.3750
gas temperature	K	375.5650	618.6600
pressure	MPa	0.2102	15.6391

The Table 5.6 shows the minimum and maximum values of void fraction, quality, mass flowrate, liquid and gas velocities, liquid and gas temperatures, pressure during the transient, upstream of the break.

DOWNSTREAM

The Figure 5.16, Figure 5.17, Figure 5.18 and Figure 5.19 represent the liquid and gas velocities, the pressure, the liquid and gas temperatures, the void fraction and the quality in the volume 667090000 downstream of the break in the DVI SPLIT line. Figure 5.20 shows the volumetric flowrate calculated using the area of the pipe, the void fraction, the gas and liquid velocities.

The mass flowrate is not shown because it is the same downstream and upstream of the break.

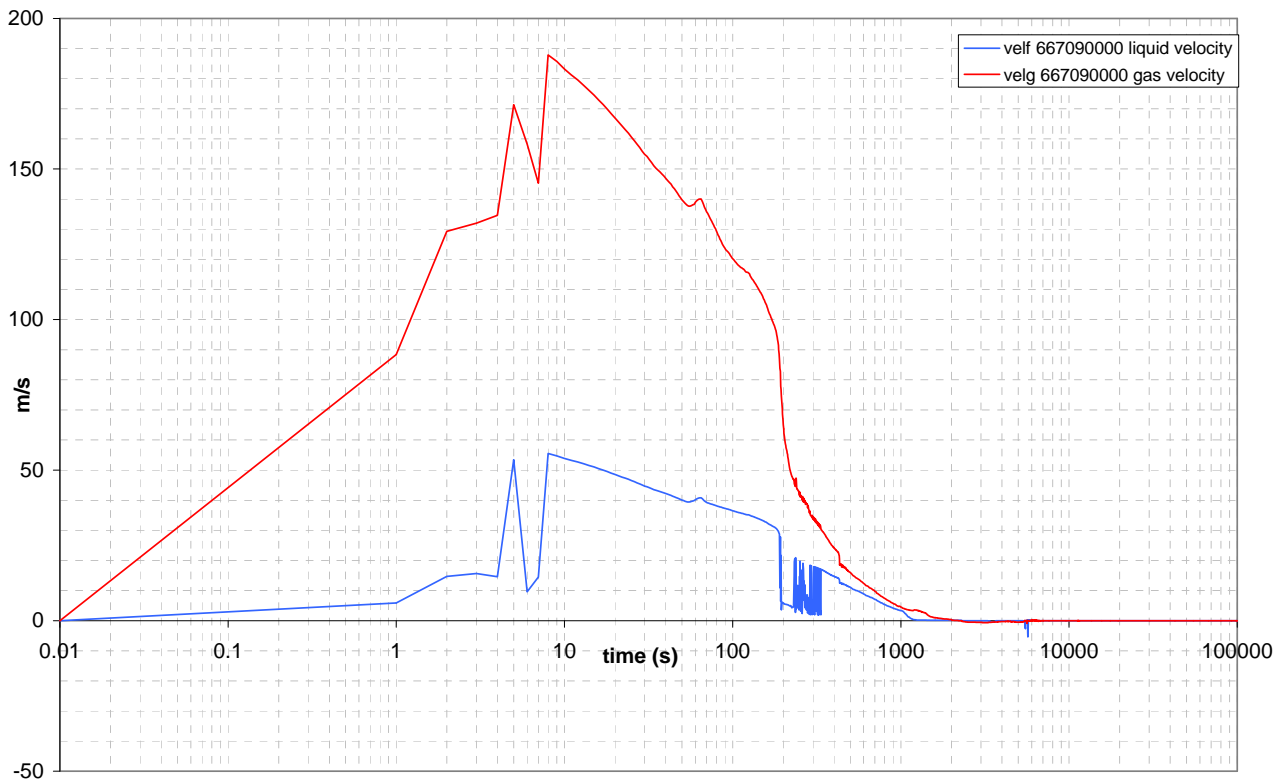

Figure 5.16: DVI SPLIT BREAK LINE liquid and gas velocities DOWNSTREAM

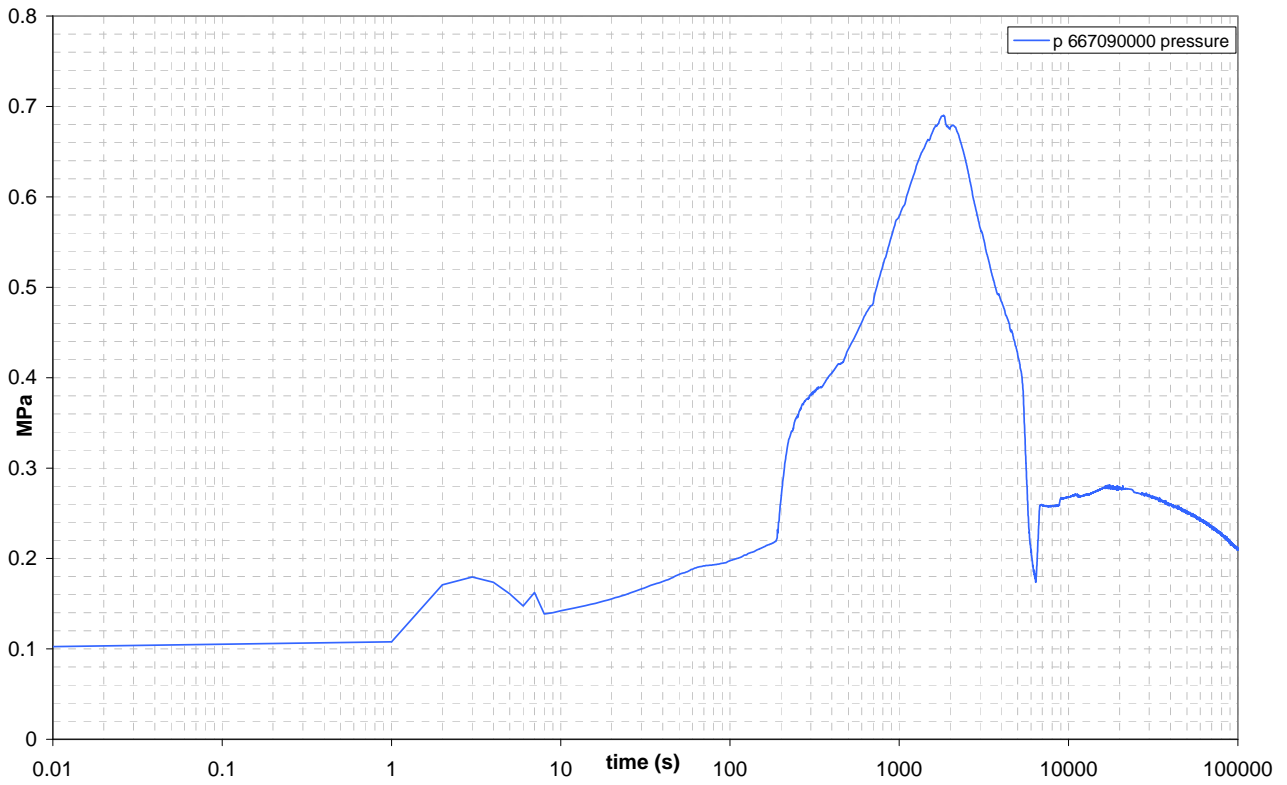

Figure 5.17: DVI SPLIT BREAK LINE pressure DOWNSTREAM

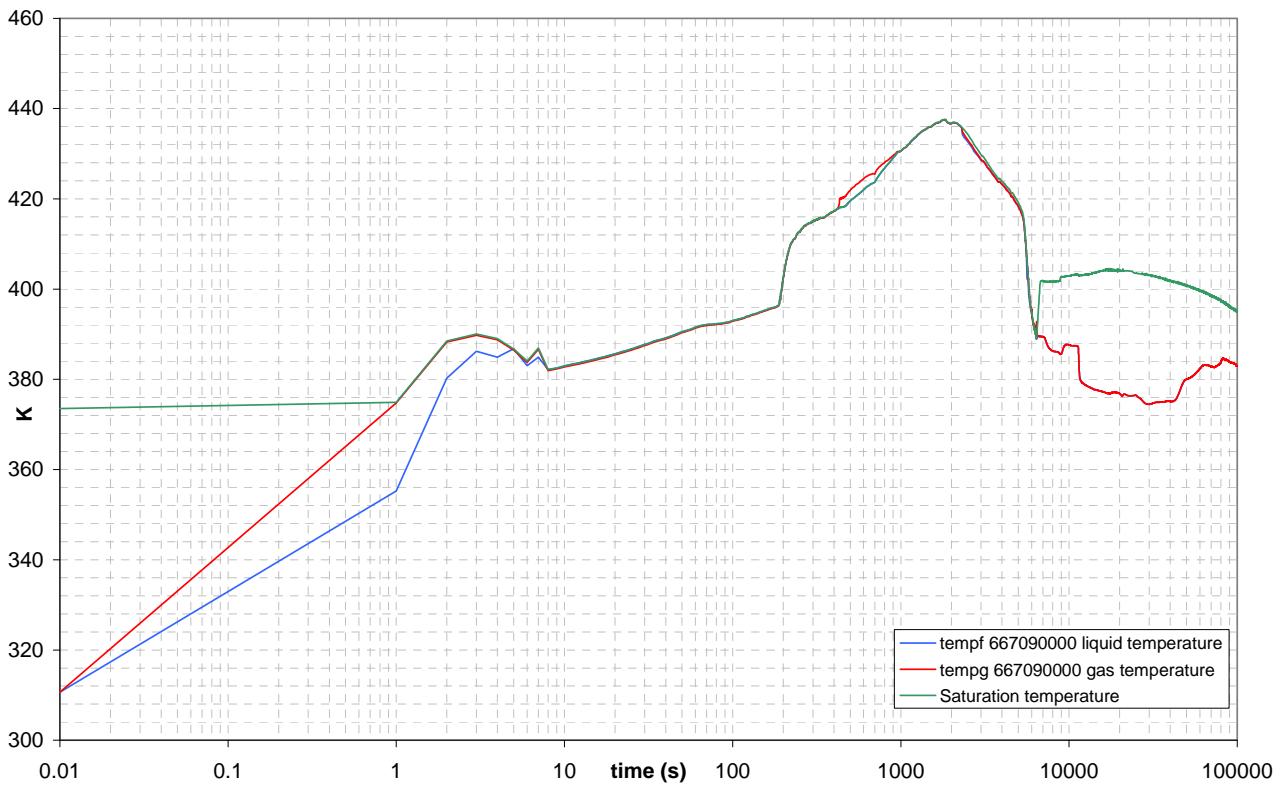

Figure 5.18: DVI SPLIT BREAK LINE liquid and gas temperatures DOWNSTREAM

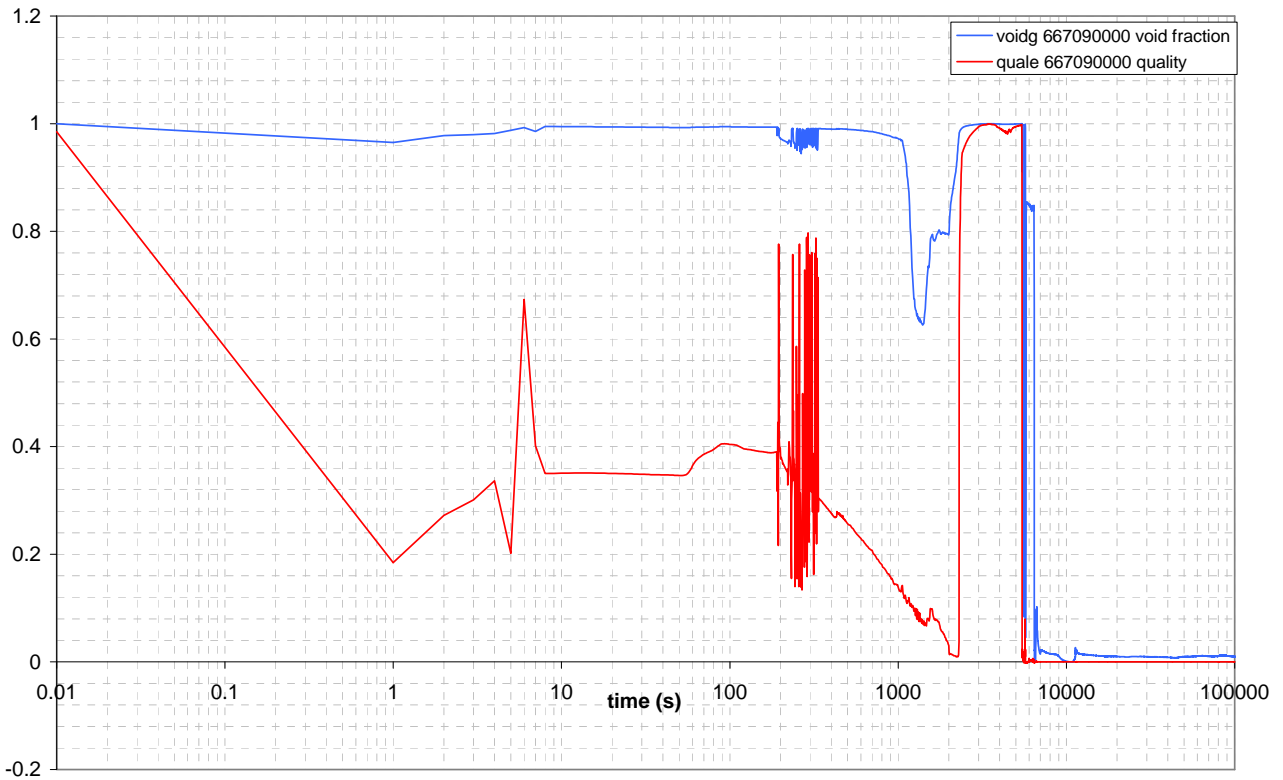

Figure 5.19: DVI SPLIT BREAK LINE void fraction and quality DOWNSTREAM

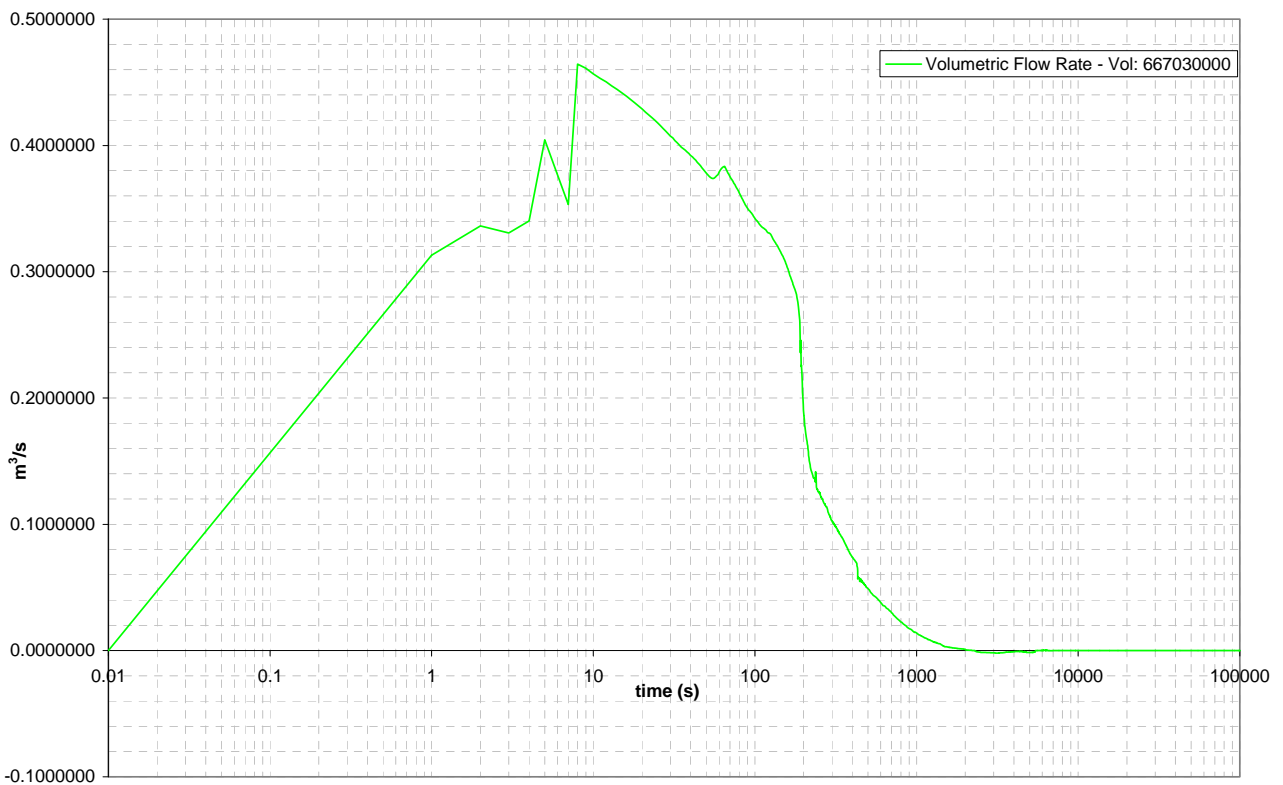

Figure 5.20: DVI SPLIT BREAK LINE volumetric flowrate DOWNSTREAM

The **Errore. L'autoriferimento non è valido per un segnalibro.** shows the minimum and maximum values of void fraction, quality, mass flowrate, liquid and gas velocities, liquid and gas temperatures, pressure and volumetric flowrate during the transient, downstream the break.

Table 5.7: Maximum and minimum values of the main variables in the
DVI SPLIT break line downstream of the break

DVI SPLIT break line DOWNSTREAM		MIN	MAX
void fraction		0**	1
volume equilibrium quality		-0.0025	0.9997
mass flowrate	kg/s	-0.1308	1.3328
liquid velocity	m/s	-5.398	55.492
gas velocity	m/s	-0.922	187.888
liquid temperature	K	355.25	437.51
gas temperature	K	374.47	437.57
pressure	MPa	0.1026	0.6902
volumetric flowrate	m ³ /s	-0.002	0.464

** At the end of the transient, after about 5000 seconds, the safety systems intervention leads to the covering of the break with water that starts to exit the rupture in liquid phase. The mass flowrate has to be estimated before the intervention, when the minimum value of the void fraction is 0.6256, as showed by Figure 5.19.

The Table 5.8 describes the flow regimes in the volume before the break and in some volumes after the break. The time step changes only when there is a modification in the flow regime. The volumes emphasized by red indicate the monitoring points.

FLOW REGIME

Table 5.8: Flow regimes function of monitoring volumes and time – DVI SPLIT LINE

Time	665010	667010	667050	667090	667140	668010
0	BBY	HST	HST	HST	HST	HST
192	BBY	ANM	ANM	ANM	ANM	ANM
334	BBY	ANM	ANM	ANM	ANM	HST
337	BBY	ANM	HST	HST	ANM	HST
432	BBY	ANM	HST	HST	HST	HST
452	HST/BBY	ANM	HST	HST	HST	HST
1740	HST	ANM	HST	HST	HST	HST
1750	HST	HST	HST	HST	HST	HST
1760	HST	ANM	HST	HST	HST	HST
2460	HST	HST	HST	HST	HST	HST
2750	HST	HST	HST	HST	HST	CHF MPR
2810	HST	HST	HST	HST	HST	HST
2990	HST	HST	HST	HST	HST	CHF MPR
3070	HST	HST	HST	HST	CHF MPR/HST	HST
4600	HST	HST	HST	HST	HST	HST
4780	HST	HST	HST	HST	HST	CHF MPR/HST
5410	HST	HST	HST	HST	CHF MPR/HST	CHF MPR/HST
5450	HST	HST	HST	HST	HST	HST
5480	BBY	HST	HST	HST	HST	HST
6200	BBY	BBY	HST	HST	HST	HST
6440	BBY	HST/BBY	HST	HST	HST	HST
6550	BBY	HST/BBY	HST	HST	BBY	HST
6580	BBY	HST/BBY	HST	HST	HST	HST
6910	HST	HST/BBY	HST	HST	HST	HST
6920	BBY	HST/BBY	HST	HST	HST	HST
7020	HST	HST/BBY	HST	HST	HST	HST
8890	BBY	BBY	HST	HST	HST	HST
9810	HST	HST	HST	HST	HST	HST
9820	HST	HST	HST	HST	BBY	HST
9850	HST	BBY	HST	HST	BBY	HST
9880	HST	BBY	HST	HST	HST/BBY	HST
10700	HST	BBY	HST	HST	BBY	HST
10710	HST	BBY	HST	BBY	BBY	HST
10740	HST	BBY	HST	HST	BBY	HST
10900	HST	BBY	HST	BBY	BBY	HST
10940	HST	BBY	BBY/HST	BBY	BBY	HST
10980	HST	BBY	BBY/HST	BBY	HST	HST
11010	HST	BBY	BBY/HST	HST	HST	HST
11160	HST	BBY	HST	HST	HST	HST
11300	HST	HST	HST	HST	HST	HST
26890	BBY	BBY	HST	HST	HST	HST
99990	HST/HST	HST/HST	HST	HST	HST	HST

5.1.2.1 Synthesis of achievements for the DVI SPLIT break

As indicated by Figure 5.13 and Table 5.6, pressure upstream of the break is very high (15.6 MPa), at least at the beginning of the transient, whereas pressure downstream of the break reaches at maximum 0.7 MPa, as shown in Figure 5.17. Therefore the installation of an eventual spool piece is suggested downstream of the break.

The void fraction, downstream of the break, varies between 0 and 1 as indicated in Figure 5.19 and The Errore. **L'autoriferimento non è valido per un segnalibro.** shows the minimum and maximum values of void fraction, quality, mass flowrate, liquid and gas velocities, liquid and gas temperatures, pressure and volumetric flowrate during the transient, downstream the break.

Table 5.7. Differently from the DVI DEG break line, water going out of the Reactor Vessel flows through the DVI SPLIT break line and the mass flow value reaches a maximum of 1.33 Kg/s. Moreover a reflux from the containment to the RV is evidenced by a negative value of the mass flow (-0.13 Kg/s), as shown by Figure 5.11 and Table 5.6 [4].

Therefore the installation of a spool piece is planned for the DVI SPLIT line. The device will be located downstream of the break in the zone corresponding to volume 667090000 of the nodalization,

As indicated in Table 5.8, it will experiment three different flow regimes: annular mist, bubbly and horizontal stratified.

For the DVI SPLIT break line, also a Venturi meter will be installed upstream of the break.

5.1.3 ADS lines

As detailed in [4], the DVI break transient foresees the ADS Stage-I lines opening to reduce pressure in the RV and anticipate the safety systems intervention to make-up water in the primary side. The ADS Stage-II lines open later in the transient, to improve the steam circulation between primary and containment systems in the upper part of the plant.

When the ADS Stage-I valves open, steam flows rapidly through the pipes sucking and entraining water from the PRZ. In this condition, a liquid fraction can flow through the pipes even if they are connected to the RV top, where steam is currently present.

The Table 5.9 describes the maximum and minimum values of mass flowrate and void fraction in the ADS single train and double train (stage I and II) during the DVI break test. These variables are essential to evaluate the possibility to apply a spool piece in these lines.

Table 5.9: Maximum and minimum values of the void fraction and mass flow in the ADS ST and DT (Stage-I and II) upstream and downstream of the valve (DVI break test)

DVI break test		Volume	MIN	MAX
ADS ST Stage-I	Void Fraction	152030000 Upstr.	0	1
ADS ST Stage-II	Void Fraction	135020000	0	1
ADS DT Stage-I	Void Fraction	142080000	0.8111	1
ADS DT Stage-II	Void Fraction	132020000	0.0986	1
ADS ST Stage-I	Void Fraction	134010000 Downst.	0**	1
ADS ST Stage-II	Void Fraction	155010000	0.9943	1
ADS DT Stage-I	Void Fraction	131010000	0.9633	1
ADS DT Stage-II	Void Fraction	145010000	0.9967	1
ADS ST Stage-I	Mass Flow kg/s	153000000	-0.1311	0.9082
ADS ST Stage-II	Mass Flow kg/s	154000000	-0.0021	0.0079
ADS DT Stage-I	Mass Flow kg/s	143000000	-0.0160	1.8389
ADS DT Stage-II	Mass Flow kg/s	144000000	-0.0097	0.0153

** This value is due to the reflux of water sucked from the quench tank around 3000 seconds. The phenomenon lasts about 300 seconds. But this event, the minimum value of the void fraction is 0.9471.

The Figure 5.21 and Figure 5.22 represent the void fraction trend in the ADS ST Stage-I line, upstream and downstream of the break and Figure 5.23 represents the mass flow. Figure 5.24, Figure 5.25, and Figure 5.26 show the same variables in the ADS DT Stage-I line. The involved volumes are 152030000 (upstream) and 134010000 (downstream) for the ST and 142080000 (upstream) and 131010000 (downstream) for the DT, Figure 4.15, Figure 4.16, Figure 4.17. Figure 5.27 and Figure 5.28 shows the volumetric flowrate calculated using the area of the pipe, the void fraction, the gas and liquid velocities.

5.1.3.1 Synthesis of achievements for the ADS lines

ADS Stage-I

Table 5.9 shows that the mass flow is appreciable in the ADS ST and DT Stage I as well as the void fraction covers a wide range (0 – 1) in the same lines. This suggests to install a spool piece on each line. The devices will be located downstream of the valves in zones corresponding to volumes 134010000 and 131010000 for the ST and DT, respectively. Table 5.10 and Table 5.11 show the minimum and maximum values (mass and volumetric flowrate, quality, void fraction, temperature, pressure, liquid and gas velocities) in these volumes that are necessary to set the spool piece.

A Venturi meter will be installed upstream of the ADS ST and DT Stage-I valves.

ADS Stage-II

Table 5.9 shows that the mass flow is very little in both the ADS ST and DT Stage-II and also the void fraction excursions are limited around 1. For this reason no spool piece will be installed on such pipes.

A Venturi meter will be installed upstream of the ADS ST and DT Stage-II valves.

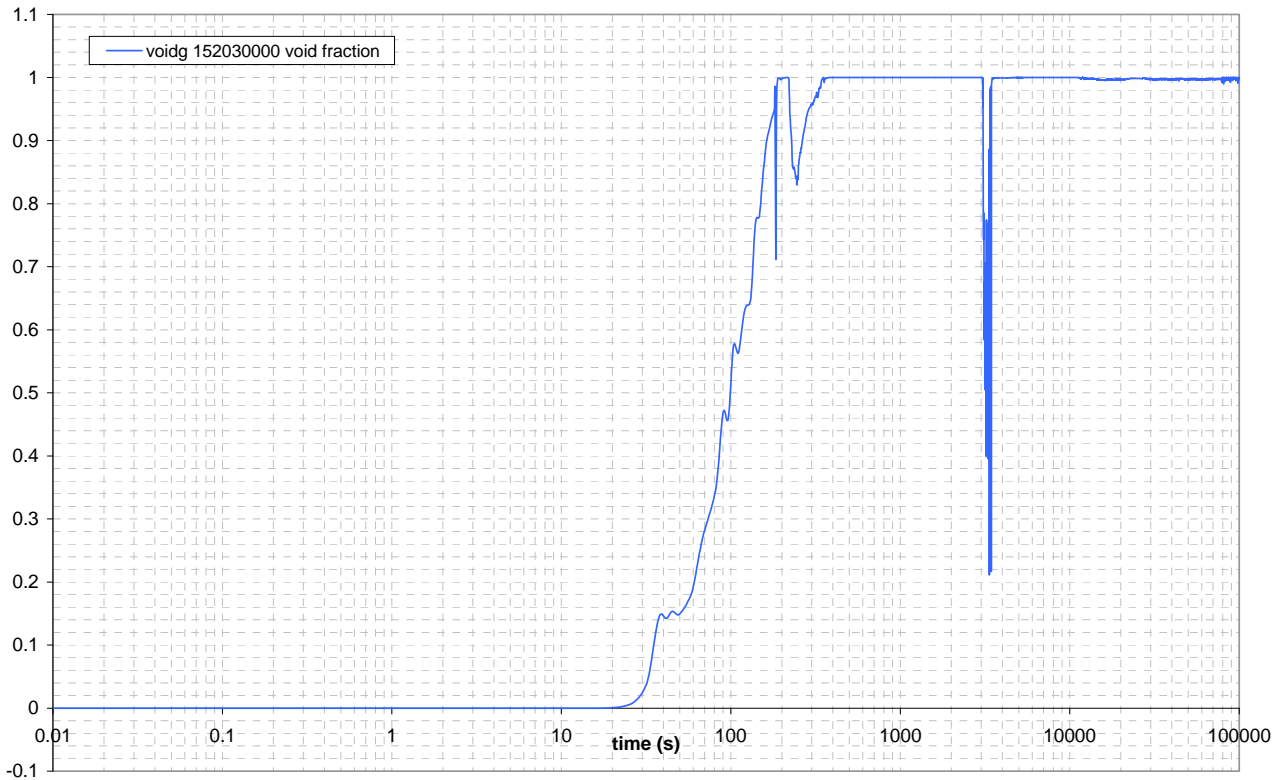

Figure 5.21: DVI TEST, ADS ST (Stage-I) LINE void fraction UPSTREAM

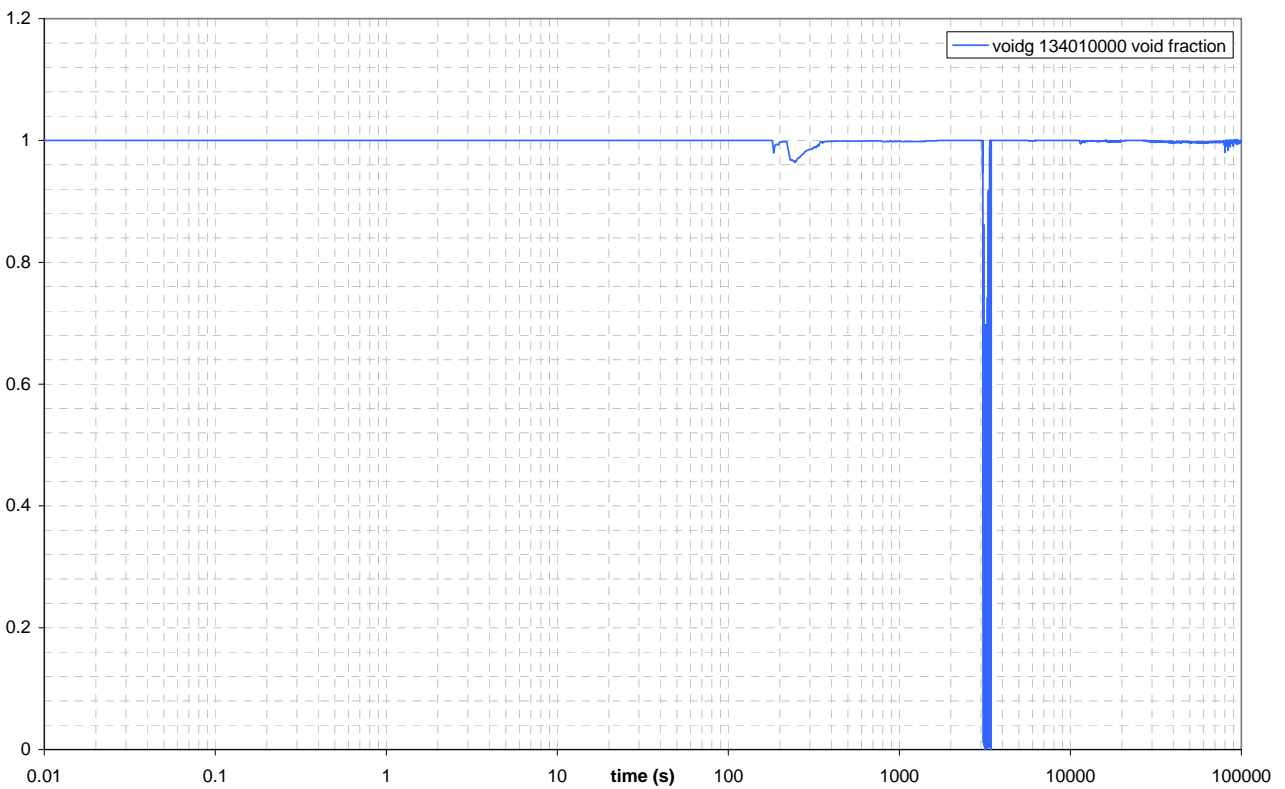

Figure 5.22: DVI TEST, ADS ST (Stage-I) LINE void fraction DOWNSTREAM

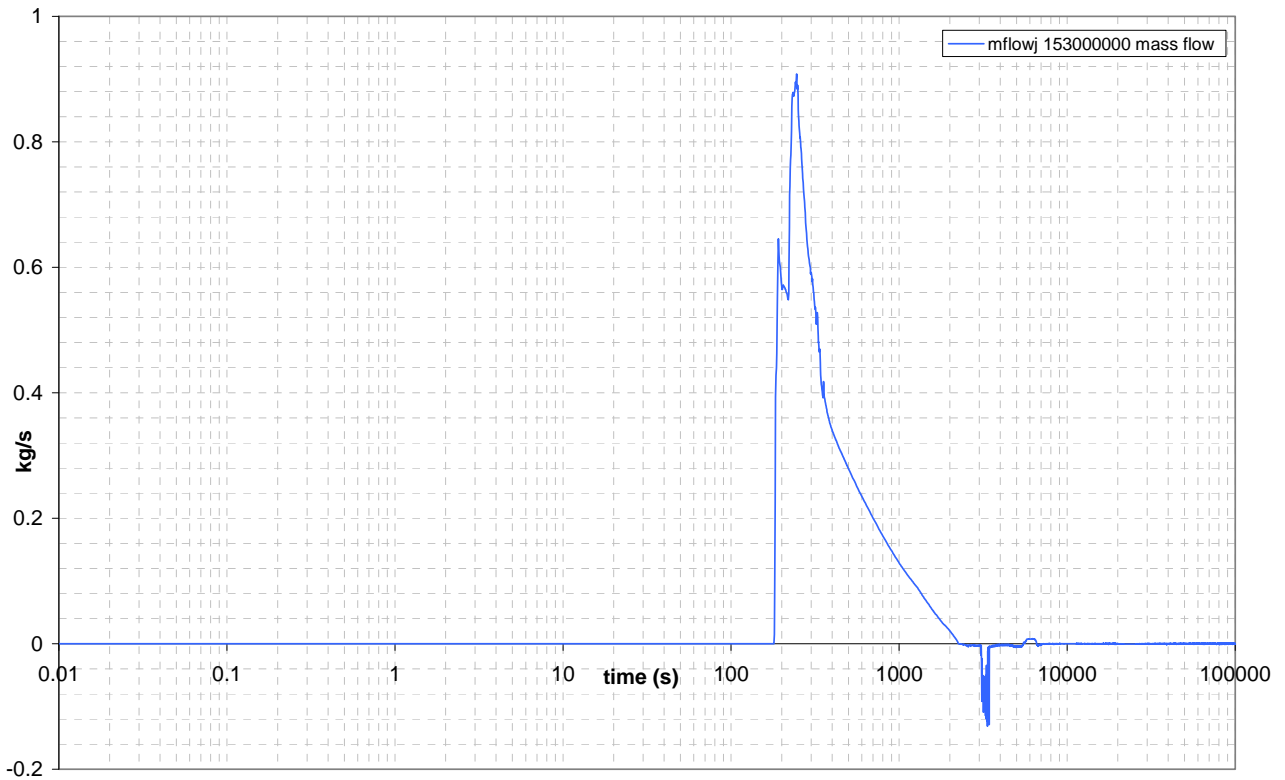

Figure 5.23: DVI TEST, ADS ST (Stage-I) LINE mass flow

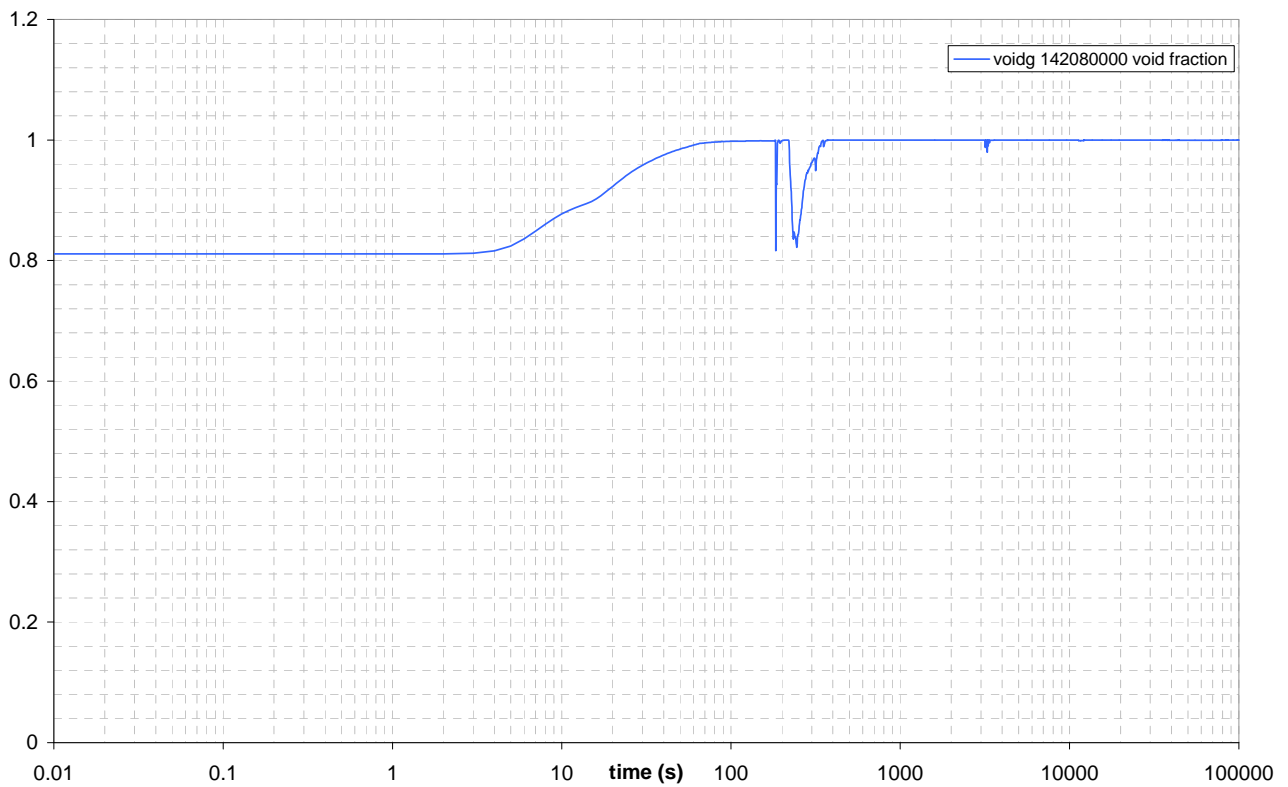

Figure 5.24: DVI TEST, ADS DT (Stage-I) LINE void fraction UPSTREAM

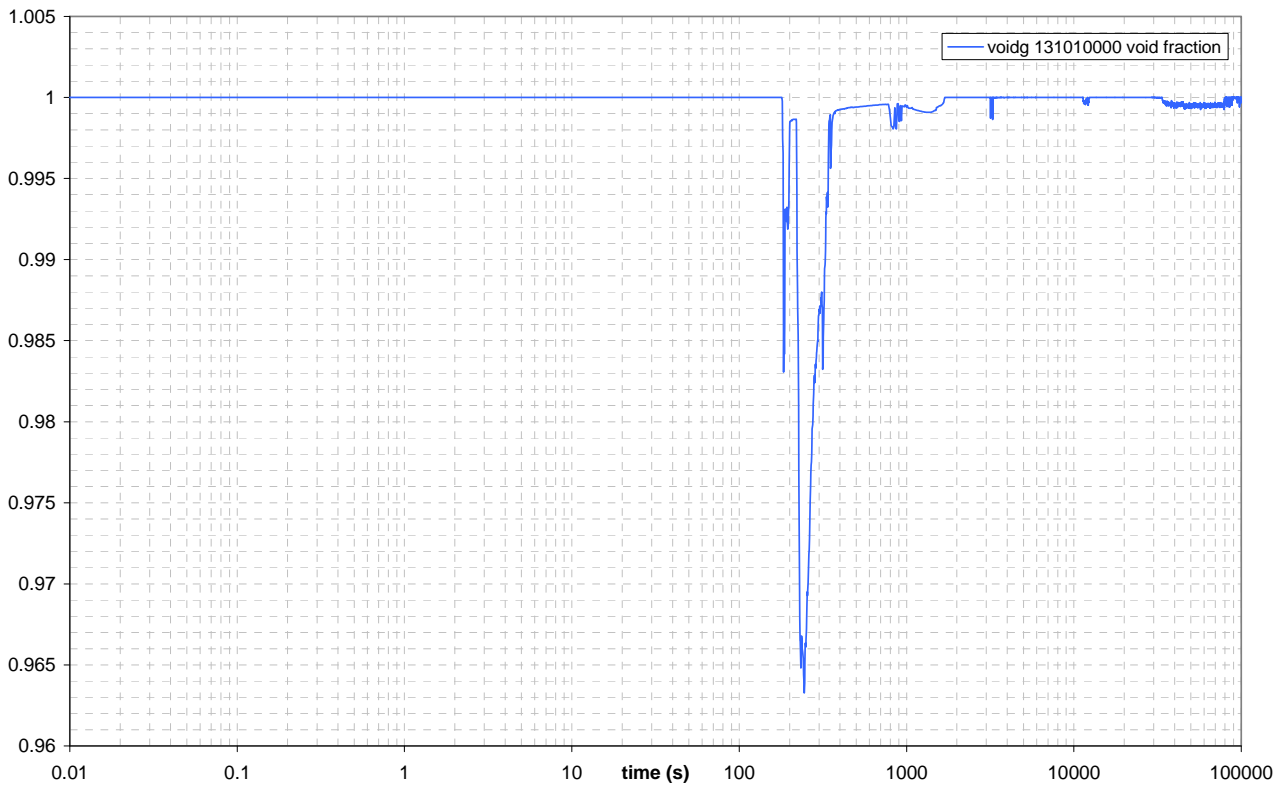

Figure 5.25: DVI TEST, ADS DT (Stage-I) LINE void fraction DOWNSTREAM

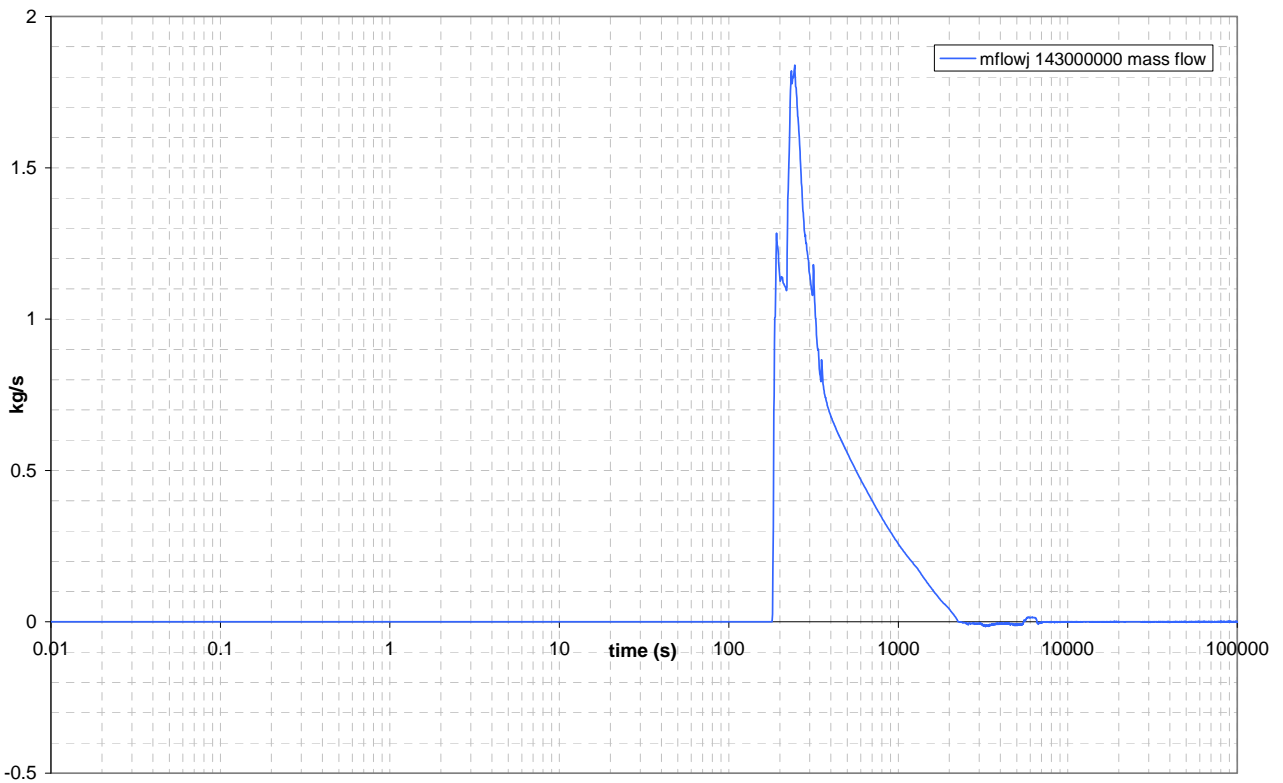

Figure 5.26: DVI TEST, ADS DT (Stage-I) LINE mass flow

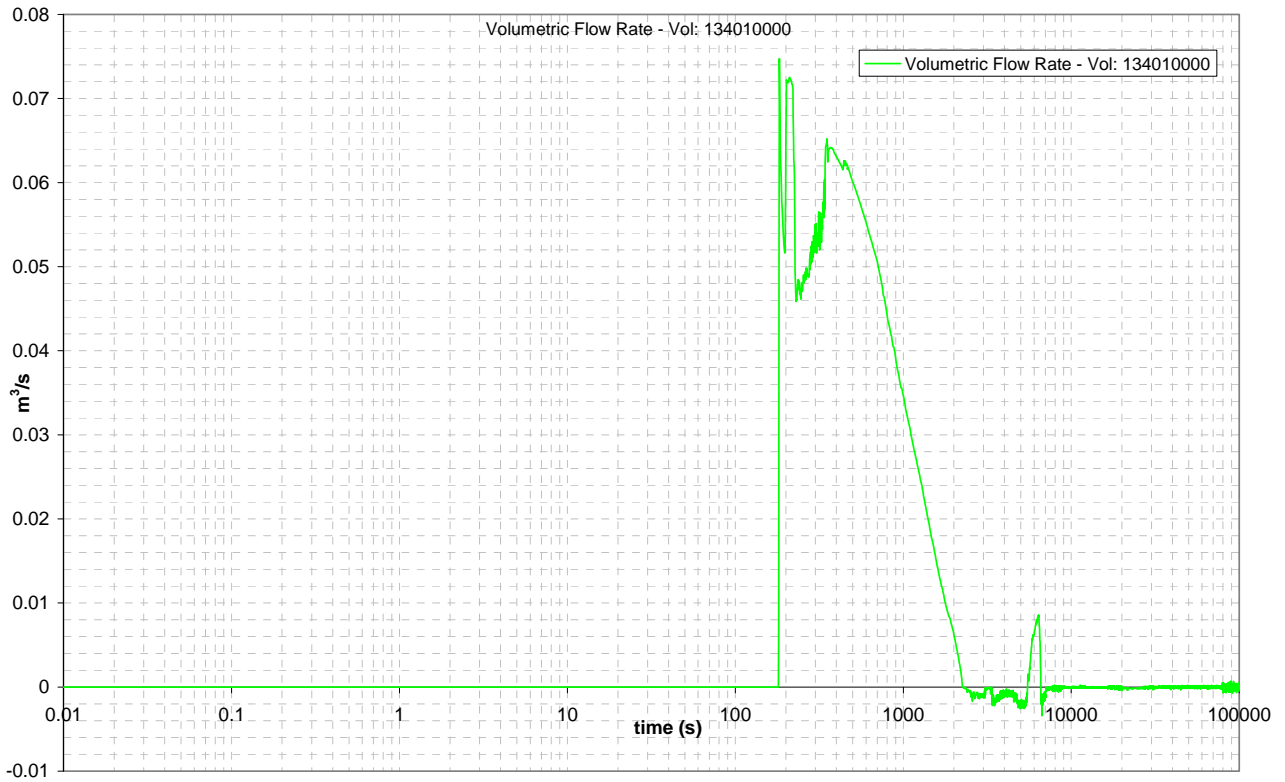

Figure 5.27: DVI TEST, ADS ST (Stage-I) LINE volumetric flowrate DOWNSTREAM

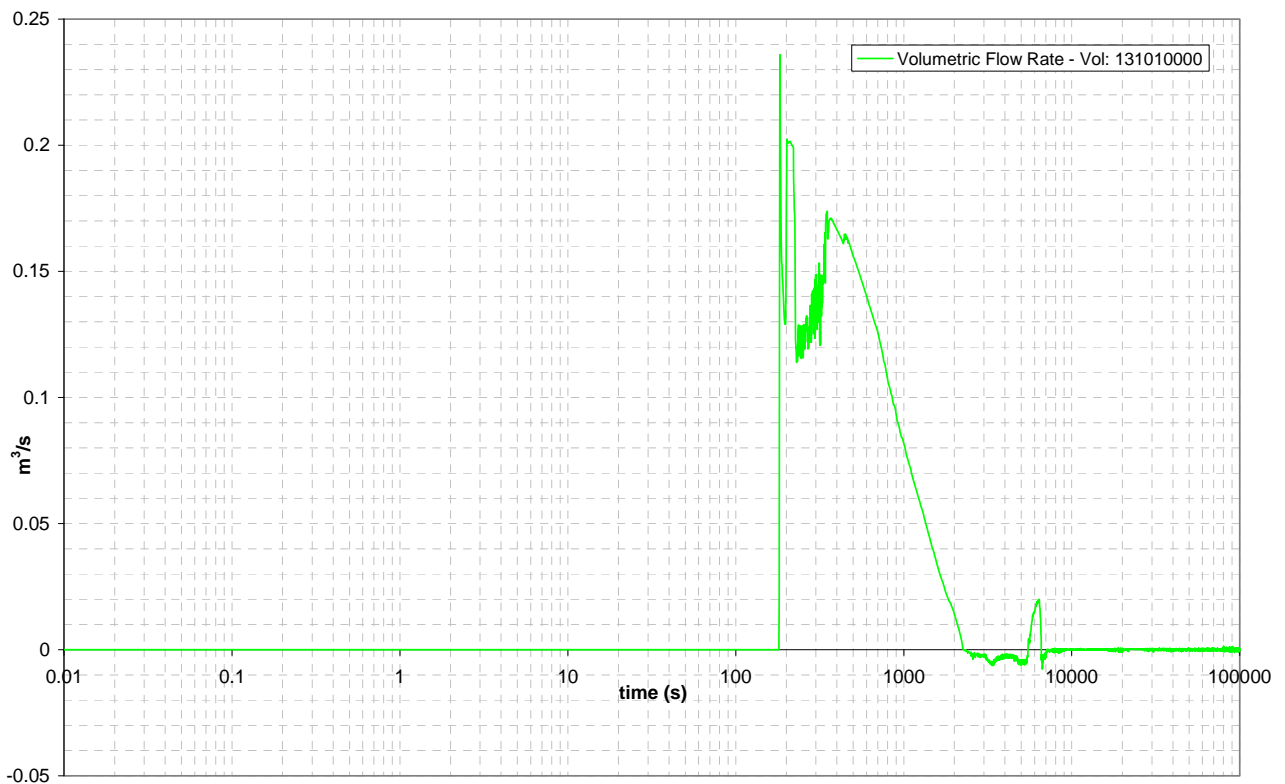

Figure 5.28: DVI TEST, ADS DT (Stage-I) LINE volumetric flowrate DOWNSTREAM

Table 5.10: Maximum and minimum values of the main variables in the ADS ST (Stage-I) downstream of the valve (DVI break test)

DVI break test – ADS ST line DOWNSTREAM		MIN	MAX
void fraction		0	1
volume equilibrium quality		-0.0002	1.0533
mass flowrate	kg/s	-0.1311	0.9082
liquid velocity	m/s	-2.9735	25.6128
gas velocity	m/s	-2.9735	66.3613
liquid temperature	K	273.16	489.34
gas temperature	K	309.808	485.118
pressure	MPa	0.1024	2.0163
volumetric flowrate	m ³ /s	-0.003	0.075

Table 5.11: Maximum and minimum values of the main variables in the ADS DT (Stage-I) downstream of the valve (DVI break test)

DVI break test – ADS DT line DOWNSTREAM		MIN	MAX
void fraction		0.9633	1
volume equilibrium quality		0.4111	1.0648
mass flowrate	kg/s	-0.0160	1.8389
liquid velocity	m/s	-2.4829	32.8595
gas velocity	m/s	-2.4829	76.6541
liquid temperature	K	273.16	485.937
gas temperature	K	311.396	487.184
pressure	MPa	0.1024	1.7946
volumetric flowrate	m ³ /s	-0.008	0.236

5.2 EBT BREAK TEST

A Design Basis Event is simulated with a 4 inch equivalent double ended guillotine (DEG) break on the EBT to RV balance line (EBT-B in the facility), but differently from the test matrix specification [1], all the safety systems are available: 3 ADS (ST and DT in SPES3), 2 EBT, 4 EHRS (EHRS-A, B and C in SPES3), 2 LGMS.

5.2.1 EBT DEG break line

The **Errore. L'autoriferimento non è valido per un segnalibro.** describes the nodalization of the EBT DEG BREAK line: one volume upstream of the valve, the junction (valve) that represents the break, seven volumes downstream of the valve and the nozzle before the tank (end of line). The main variables and the flow regimes have been taken in the volumes indicated by “*”.

Table 5.12: Description of the volumes for the EBT DEG break

UPSTREAM	MOTOR VALVE	DOWNSTRAM	NOZZLE
652010000 (*)	653000000	654010000 654020000 654030000 (*) 654040000 654050000 654060000 654070000	655010000

UPSTREAM

The Figure 5.29, Figure 5.30, Figure 5.31, Figure 5.32 and Figure 5.33 represent the mass flowrate, the liquid and gas velocities, the pressure, the liquid and gas temperatures, the void fraction and the quality of the volume 652010000 upstream of the break in the EBT DEG line, Figure 4.8.

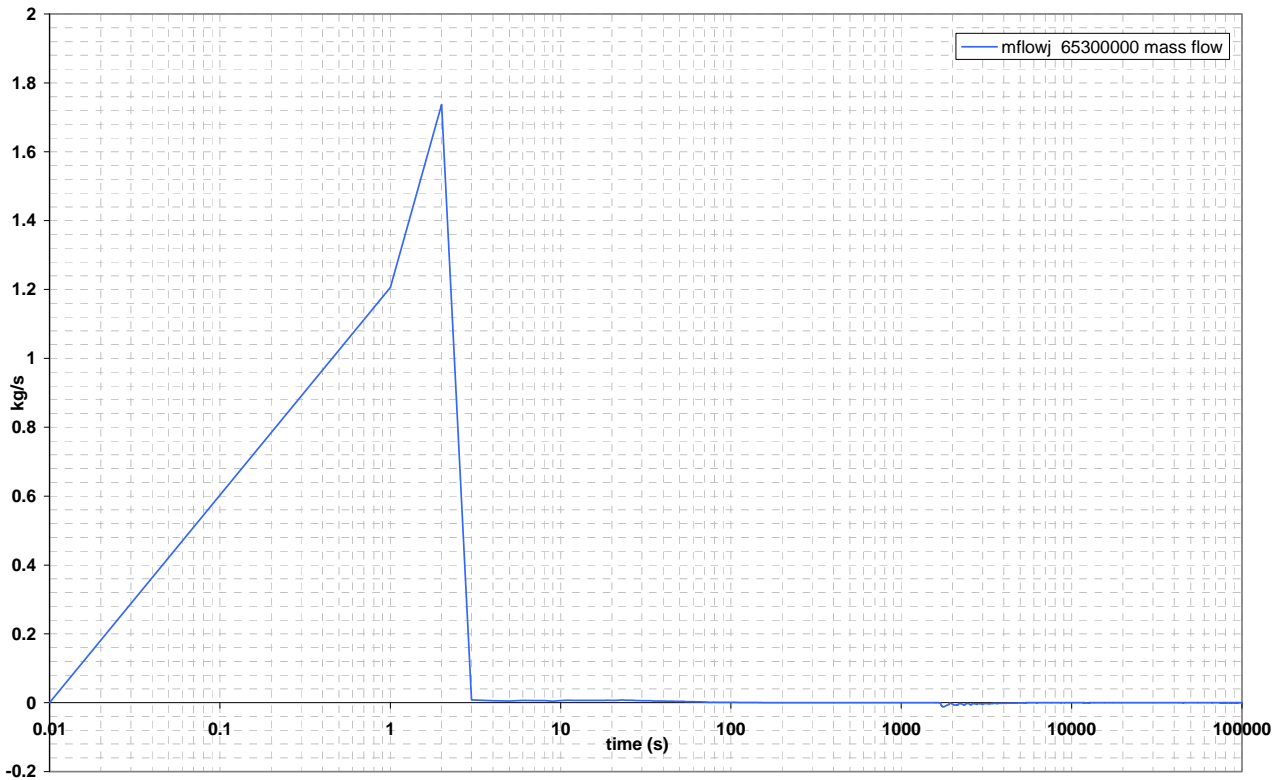

Figure 5.29: EBT DEG BREAK LINE mass flowrate

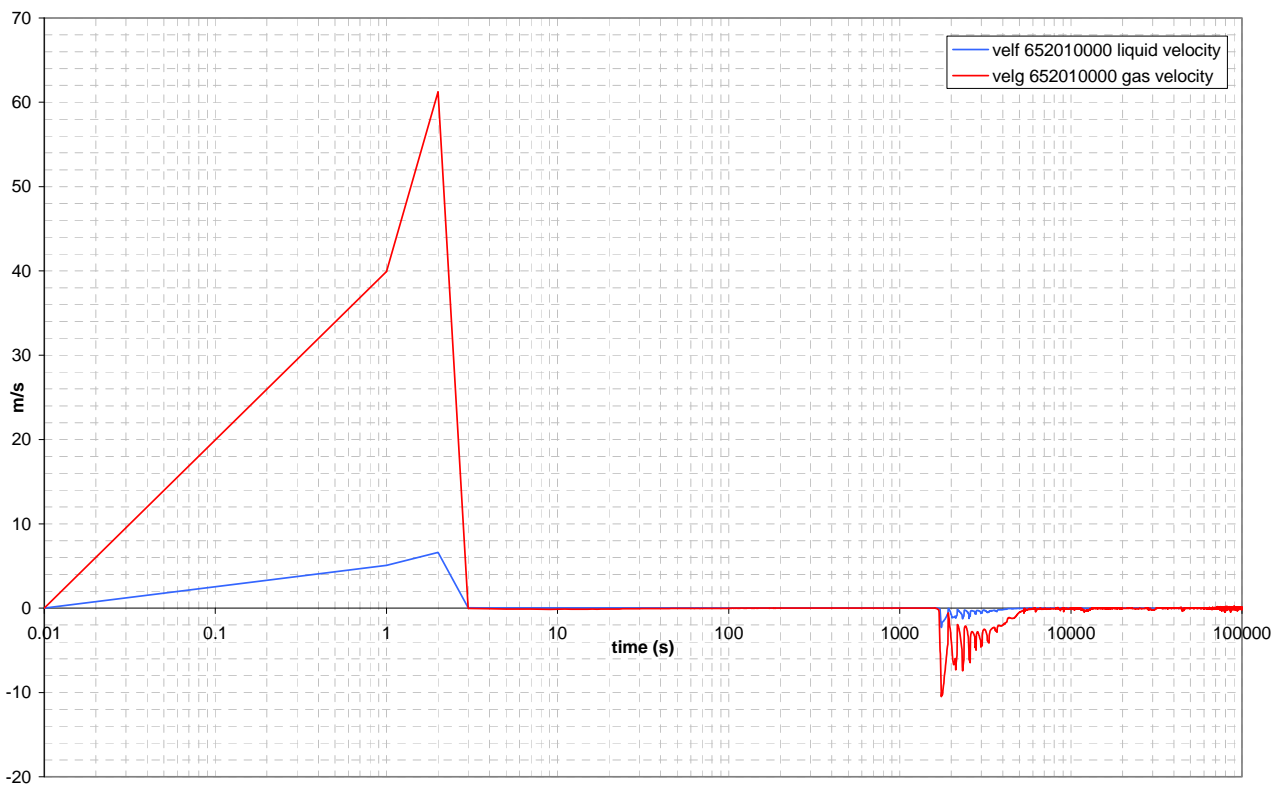

Figure 5.30: EBT DEG BREAK LINE liquid and gas velocities UPSTREAM

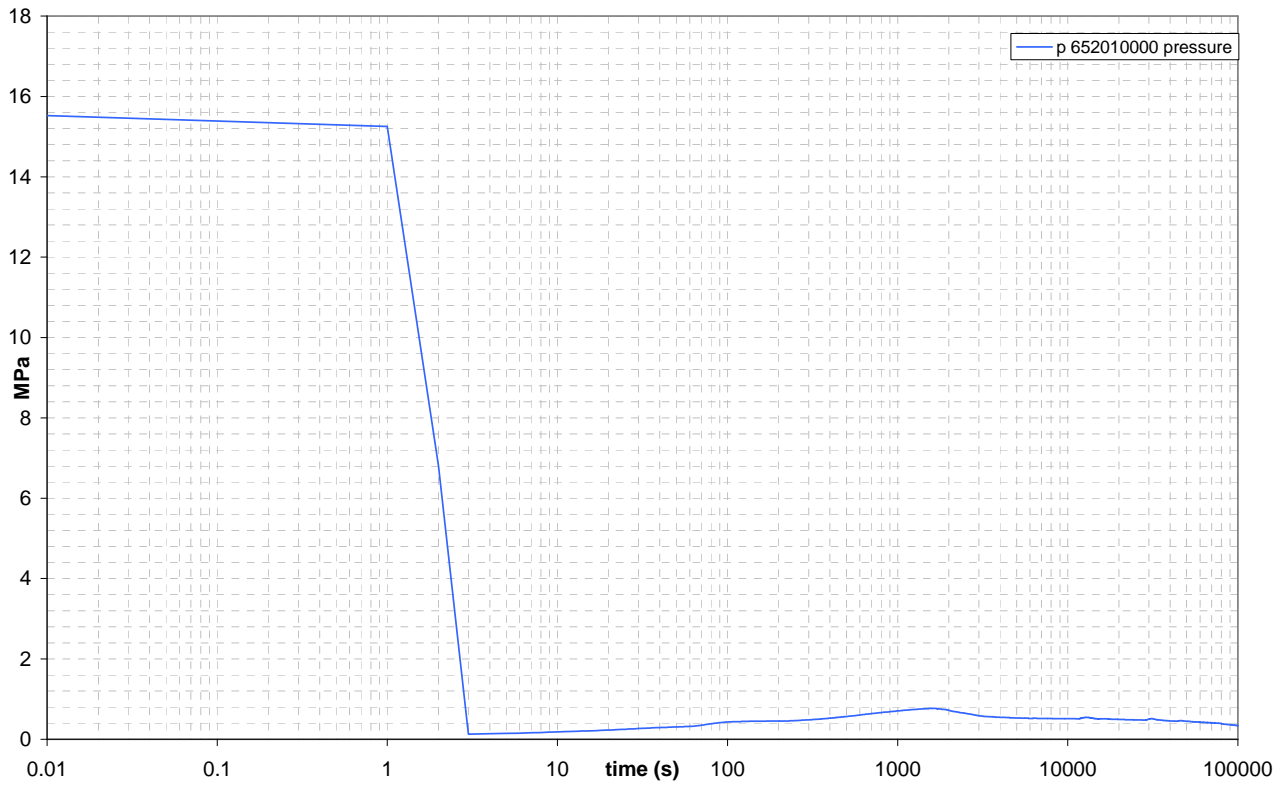

Figure 5.31: EBT DEG BREAK LINE pressure UPSTREAM

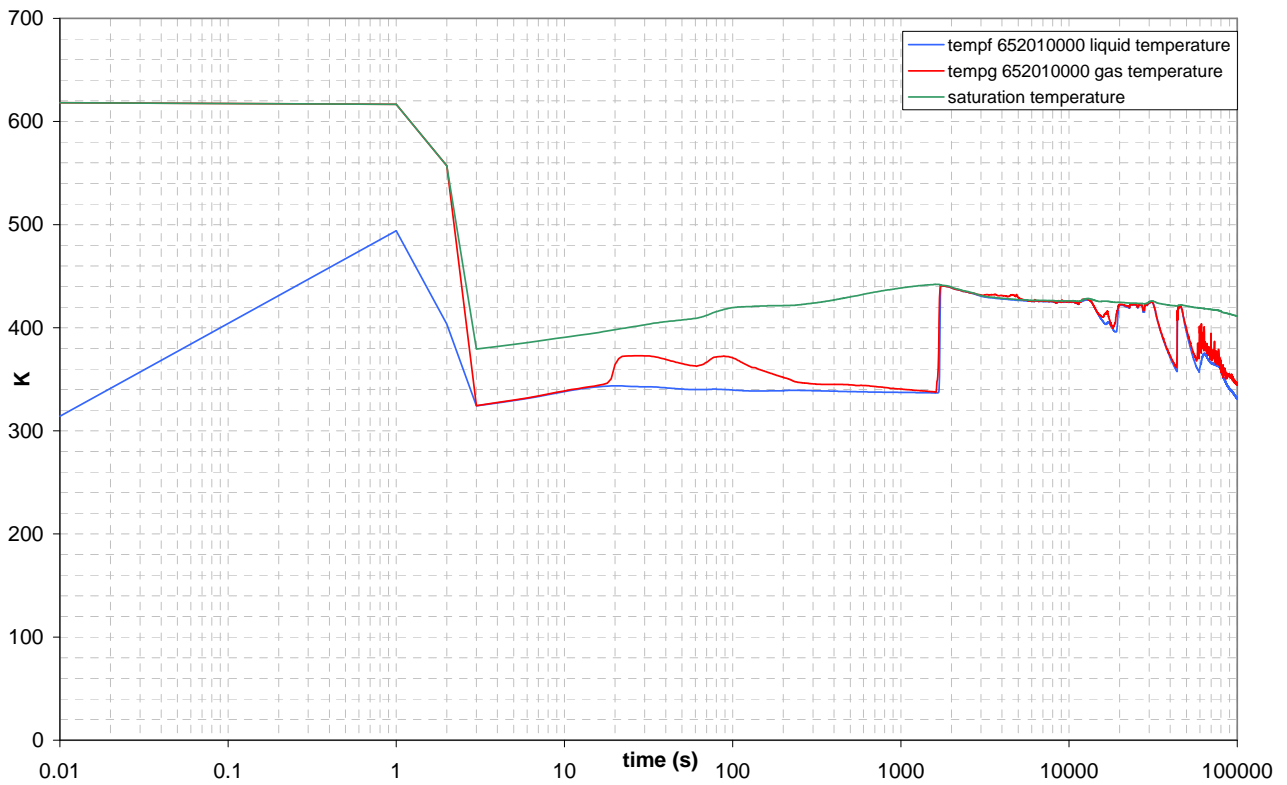

Figure 5.32: EBT DEG BREAK LINE liquid and gas temperatures UPSTREAM

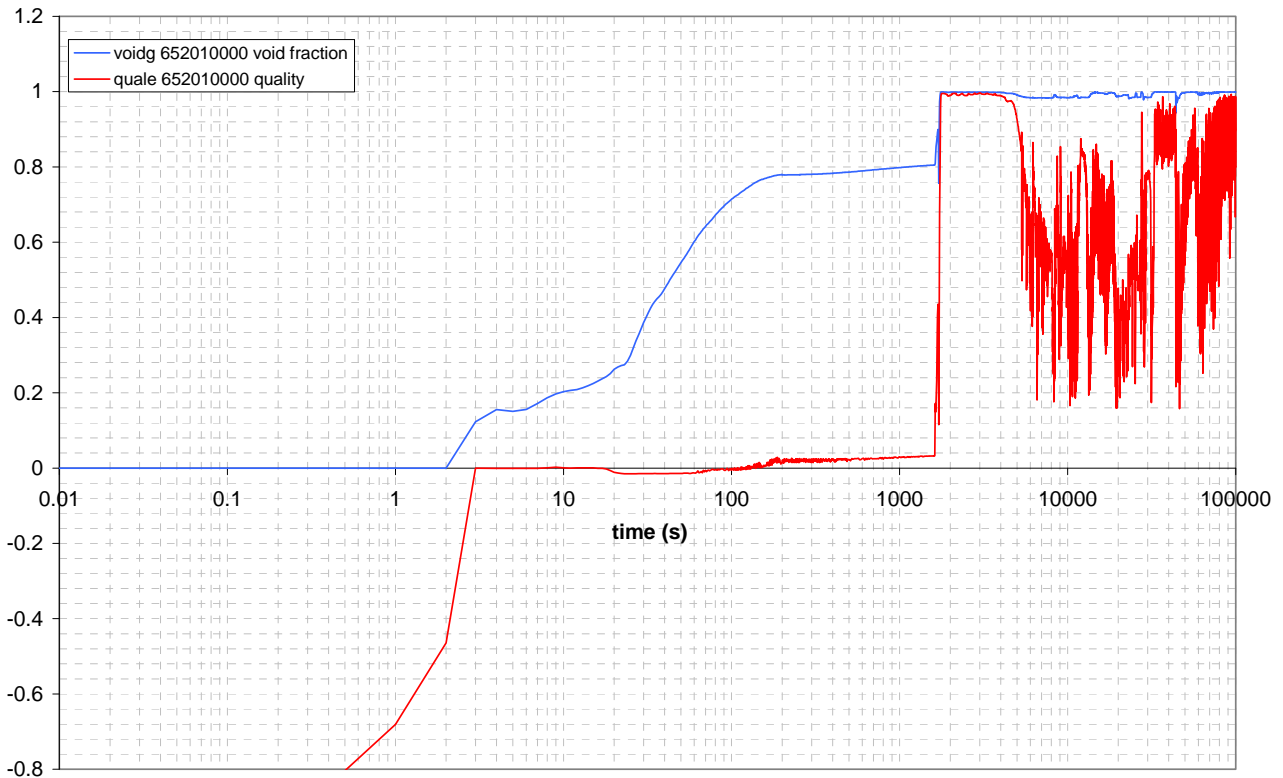

Figure 5.33: EBT DEG BREAK LINE void fraction and quality UPSTREAM

Table 5.13: Maximum and minimum values of the main variables in the EBT DEG break line upstream of the valve

EBT DEG break line UPSTREAM		MIN	MAX
void fraction		0.0000	0.9997
volume equilibrium quality		-1.4991	0.9964
mass flowrate	kg/s	-0.0122	1.7372
liquid velocity	m/s	-2.2831	6.5990
gas velocity	m/s	-10.4934	61.2530
liquid temperature	K	314.0290	493.8590
gas temperature	K	324.3550	618.0670
pressure	MPa	0.1257	15.5245

The Table 5.13 shows the minimum and maximum values of void fraction, quality, mass flowrate, liquid and gas velocities, liquid and gas temperatures, pressure during the transient, upstream the break.

DOWNSTREAM

The Figure 5.34, Figure 5.35, Figure 5.36 and Figure 5.37 represent the liquid and gas velocities, the pressure, the liquid and gas temperatures, the void fraction and the quality in the volume 654030000, downstream of the break in the EBT DEG line, Figure 4.8. Figure 5.38 shows the volumetric flowrate calculated using the area of the pipe, the void fraction, the gas and liquid velocities.

The mass flowrate is not shown because it is the same downstream and upstream of the break.

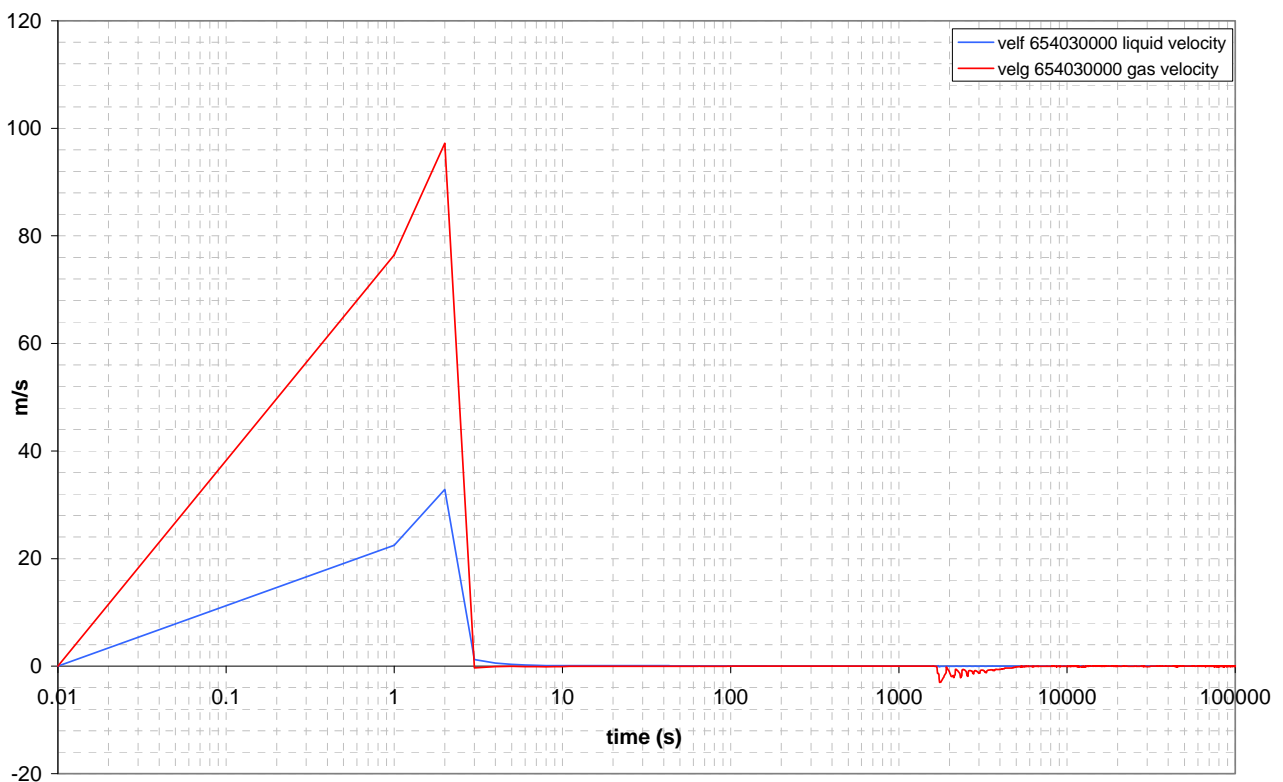

Figure 5.34: EBT DEG BREAK LINE liquid and gas velocities DOWNSTREAM

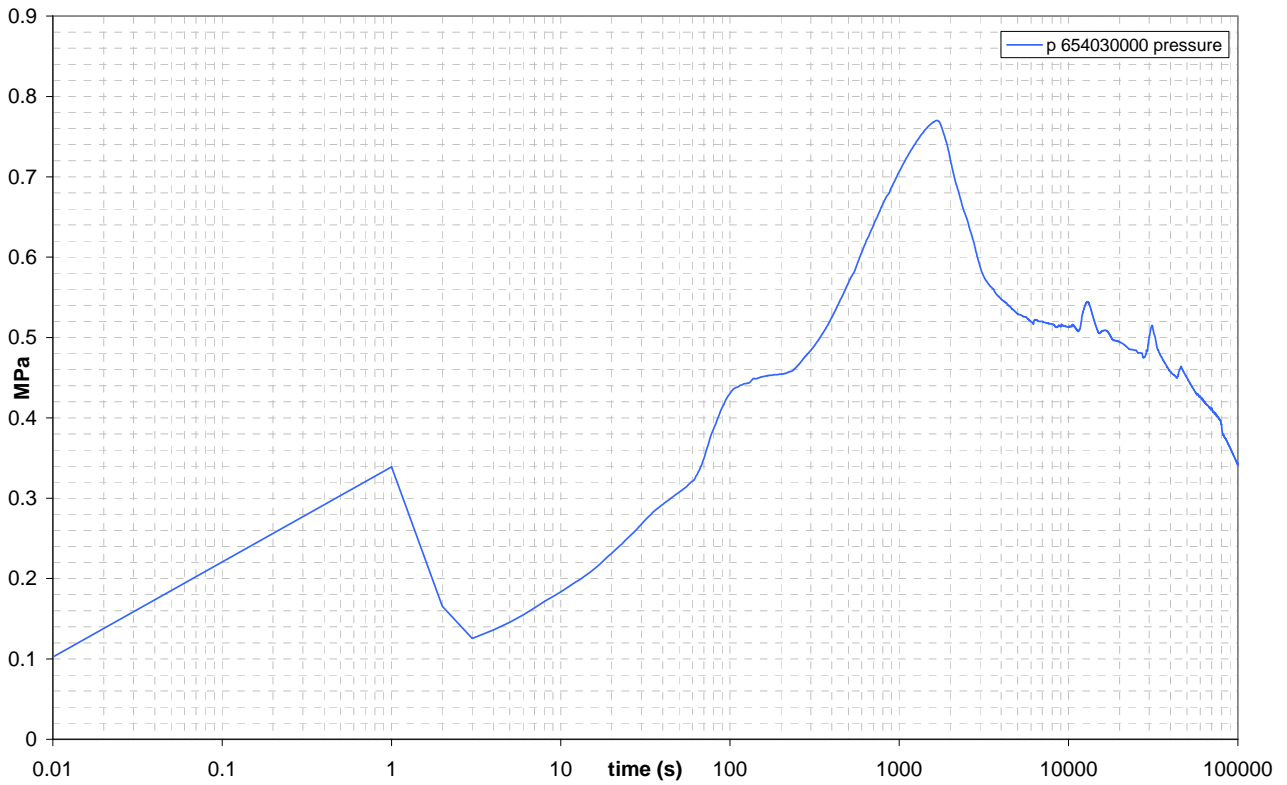

Figure 5.35: EBT DEG BREAK LINE pressure DOWNSTREAM

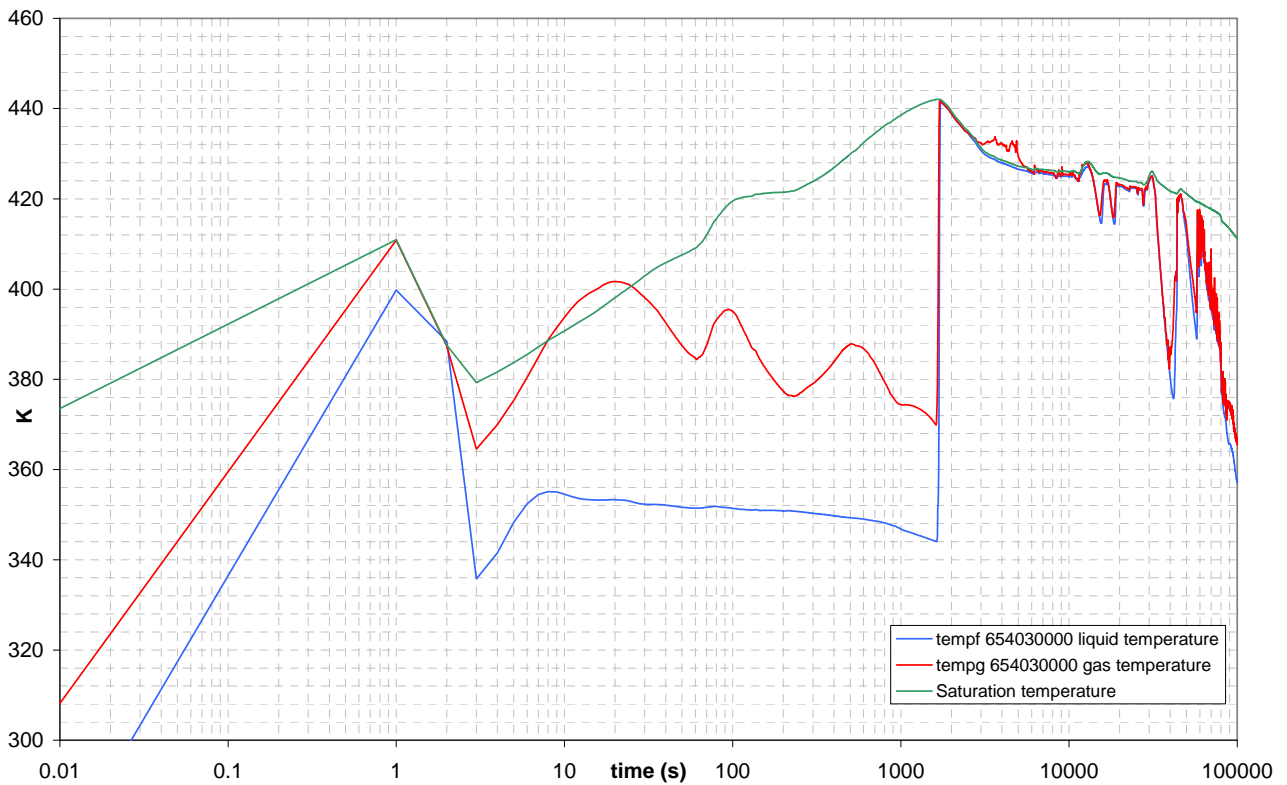

Figure 5.36: EBT DEG BREAK LINE liquid and gas temperatures DOWNSTREAM

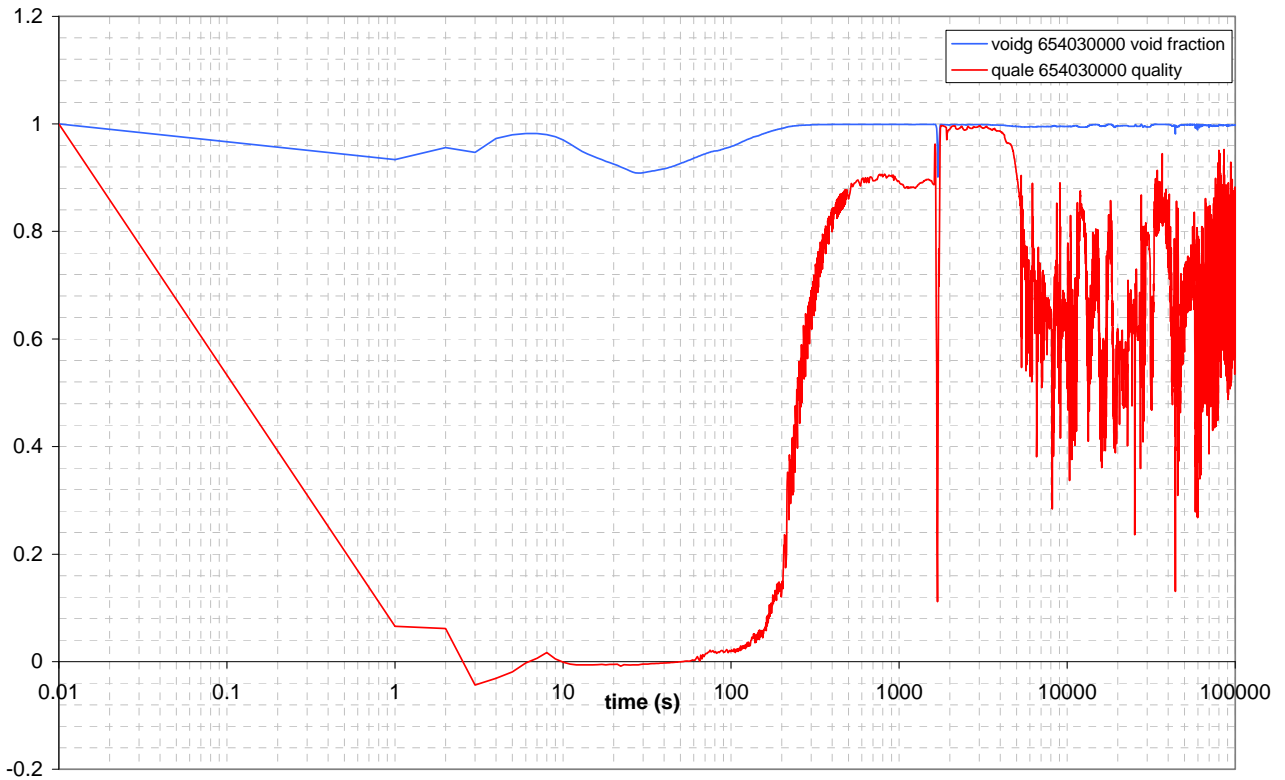

Figure 5.37: EBT DEG BREAK LINE void fraction and quality DOWNSTREAM

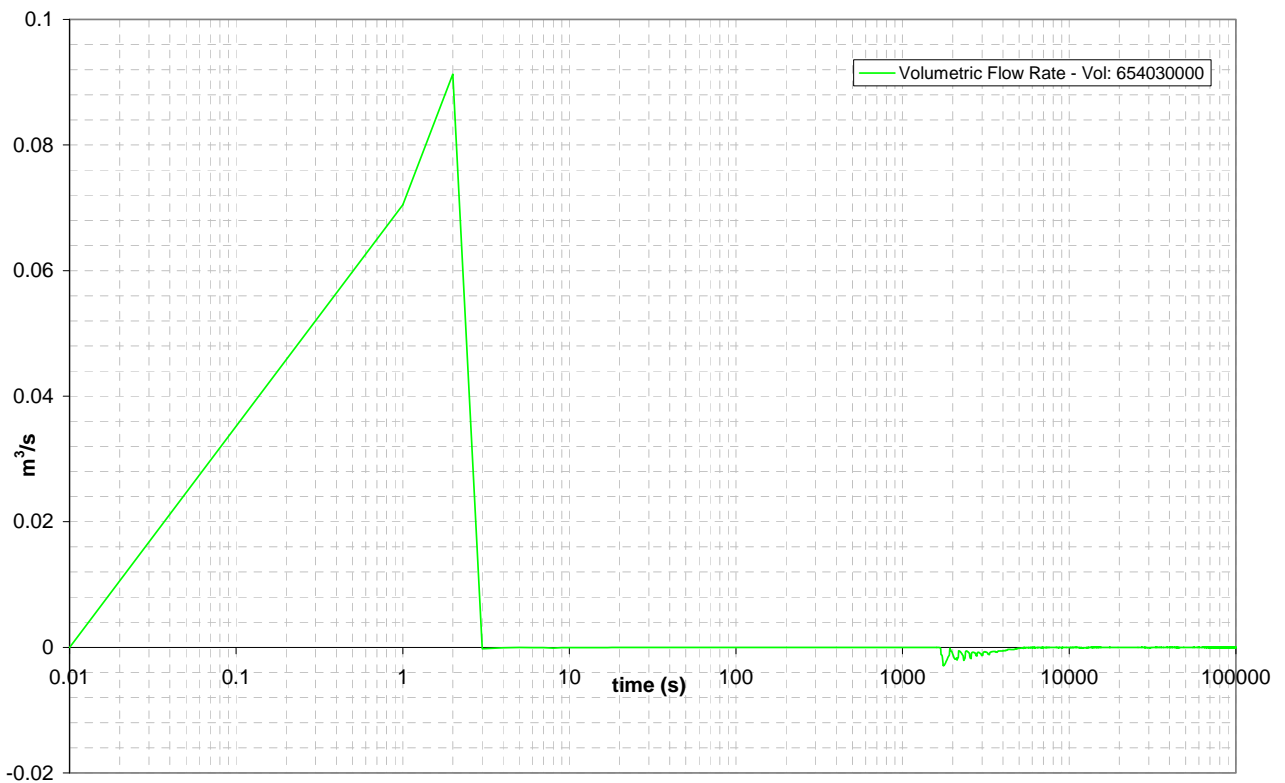

Figure 5.38: EBT DEG BREAK LINE volumetric flowrate DOWNSTREAM

The **Errore. L'autoriferimento non è valido per un segnalibro.** shows the minimum and maximum values of void fraction, quality, mass flowrate, liquid and gas velocities, liquid and gas temperatures, pressure and volumetric flowrate during the transient, downstream of the break.

Table 5.14: Maximum and minimum values of the main variables in the
EBT DEG break line downstream of the break

EBT DEG break line DOWNSTREAM		MIN	MAX
void fraction		0.9011	1
volume equilibrium quality		-0.045	1
mass flowrate	kg/s	-0.0122	1.7372
liquid velocity	m/s	-0.094	32.895
gas velocity	m/s	-3.037	97.203
liquid temperature	K	335.79	441.42
gas temperature	K	364.54	441.74
pressure	MPa	0.102451	0.770127
volumetric flowrate	m ³ /s	-0.003	0.091

The Table 5.15 describes the flow regimes in the volume before the break and in some volumes after the break. The time step changes only when there is a modification in the flow regime. The volumes highlighted in red indicate the monitoring points.

FLOW REGIMES

Table 5.15: Flow regimes function of monitoring volumes and time – EBT DEG line

Time	652010000	654010000	654030000	654070000	655010000
0	BBY	CHF MPR	CHF MPR	CHF MPR	CHF MPR
2	BBY	ANM	ANM	ANM	ANM
1700	HST	HST	HST	HST	ANM
1720	HST	SLG	HST	HST	ANM
2040	HST	HST	HST	HST	HST
2310	HST	HST	HST	HST	CHF MPR
2370	HST	HST	HST	HST	HST
3240	HST	HST	HST	HST	CHF MPR
3620	HST	HST	HST	HST	HST
3640	HST	HST	HST	HST	CHF MPR
99990	HST	HST	HST	HST	HST

5.2.1.1 Synthesis of achievements for the EBT DEG break

As indicated by Figure 5.31 and Table 5.13, pressure upstream the break is very high (15.5 MPa), at least at the beginning of the transient, whereas pressure downstream of the break reaches a maximum of 0.77 MPa, as shown in Figure 5.35. Therefore the installation of an eventual spool piece is suggested downstream of the break.

Upstream of the break, the void fraction varies between 0 and 0.9997, being such line covered by water in the early phases of the transient, but uncovering soon when the RV level decreases for the LOCA [4], Figure 5.33 and Table 5.13. Downstream of the break, the void fraction is always high, between 0.9012 and 1, as shown in Figure 5.37 and The Errore. **L'autoriferimento non è valido per un segnalibro.** shows the minimum and maximum values of void fraction, quality, mass flowrate, liquid and gas velocities, liquid and gas temperatures, pressure and volumetric flowrate during the transient, downstream of the break.

Table 5.14. Moreover, as shown in Figure 5.29, the mass flowrate is appreciable only in the first seconds of the transient and goes down to zero after 3 s. Consequently, the velocities downstream of the break are very low, as shown in Figure 5.34.

This avoids the need to install a spool piece on the EBT DEG break line.

For the EBT DEG break line, a Venturi meter will be installed upstream of the break.

5.2.2 EBT SPLIT break line

The Table 5.16 describes the nodalization of the EBT SPLIT BREAK line: one volume upstream of the valve, the junction (valve) that represents the break, seven volumes downstream of the valve and the nozzle before the tank (end of line). The main variables and the flow regimes have been taken in the volumes indicated by “*”.

Table 5.16: Description of the volumes for the EBT SPLIT break

UPSTREAM	MOTOR VALVE	DOWNSTREAM	END OF LINE
622010000 (*)	643000000	644010000	645010000
		644020000	
		644030000 (*)	
		644040000	
		644050000	
		644060000	
		644070000	

UPSTREAM

The Figure 5.39, Figure 5.40, Figure 5.41, Figure 5.42 and Figure 5.43 represent the mass flowrate, the liquid and gas velocities, the pressure, the liquid and gas temperatures, the void fraction and the quality of the volume 622010000, upstream of the break in the EBT SPLIT line,

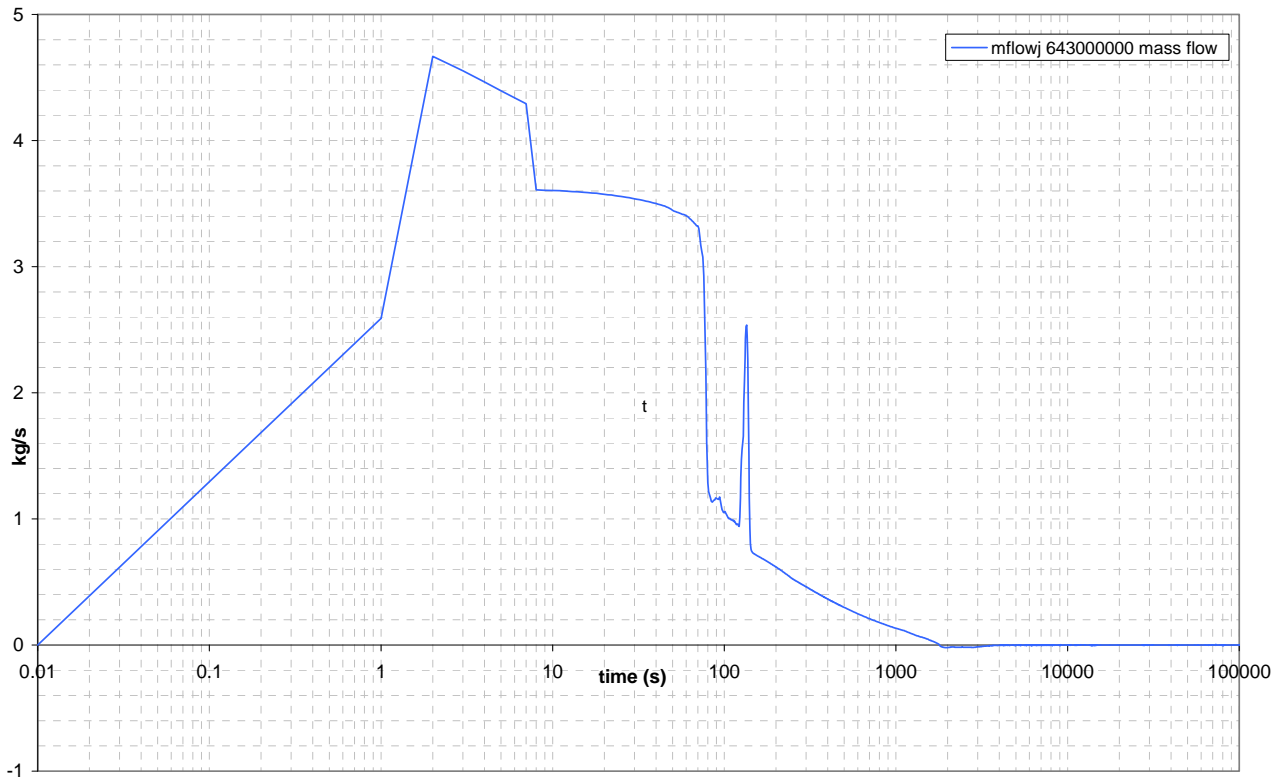

Figure 5.39: EBT SPLIT BREAK LINE mass flowrate

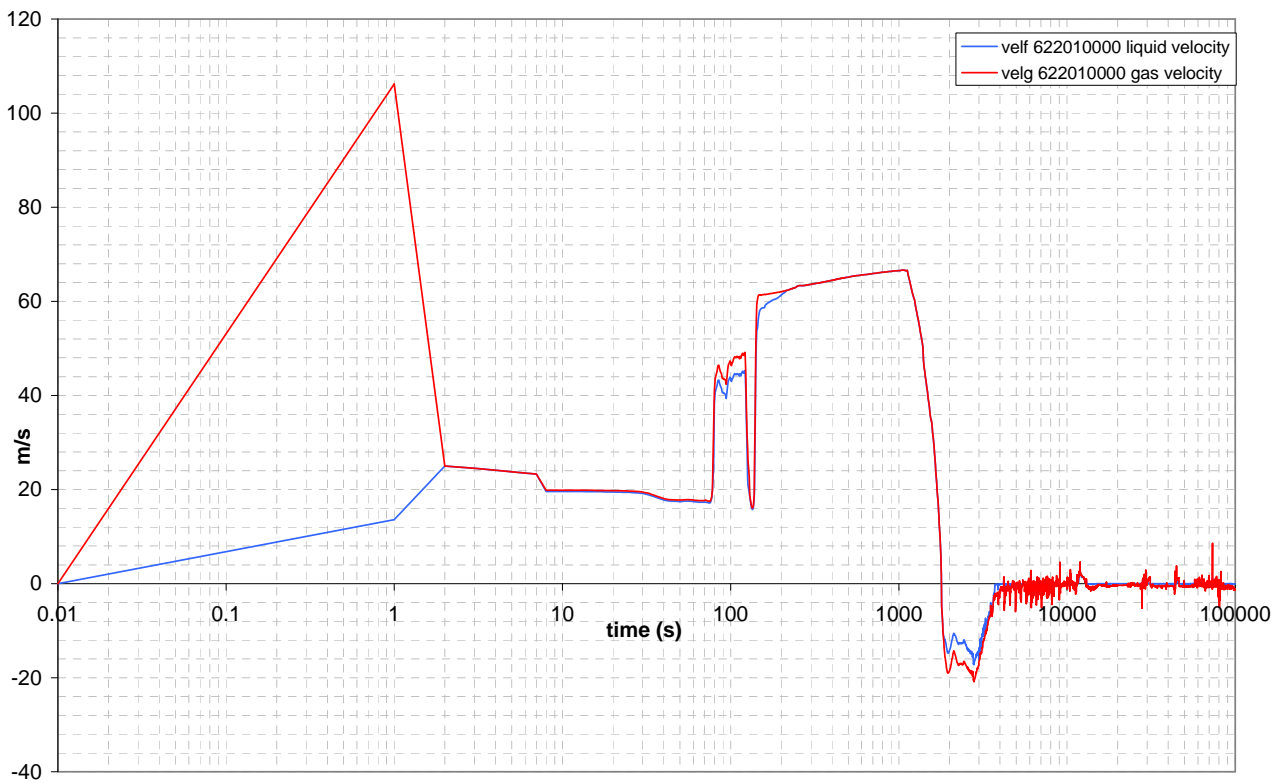

Figure 5.40: EBT SPLIT BREAK LINE liquid and gas velocities UPSTREAM

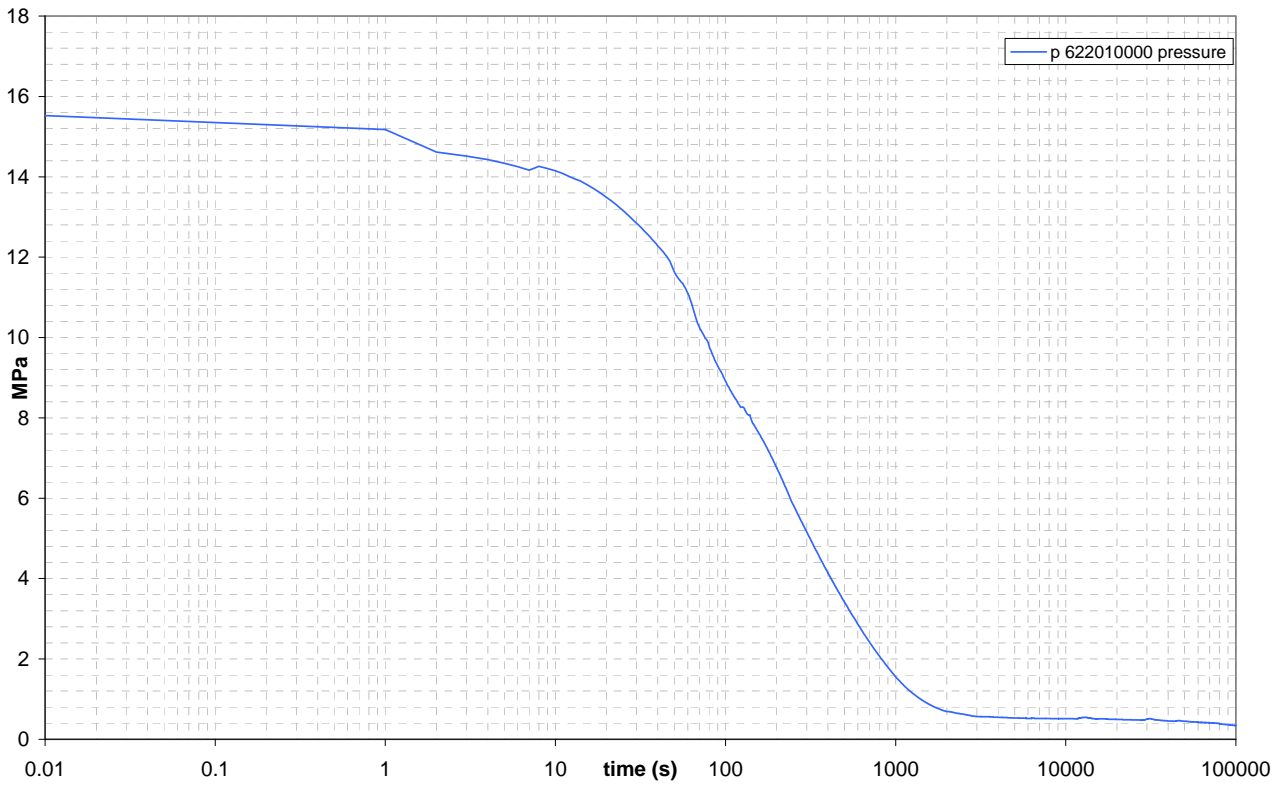

Figure 5.41: EBT SPLIT BREAK LINE pressure UPSTREAM

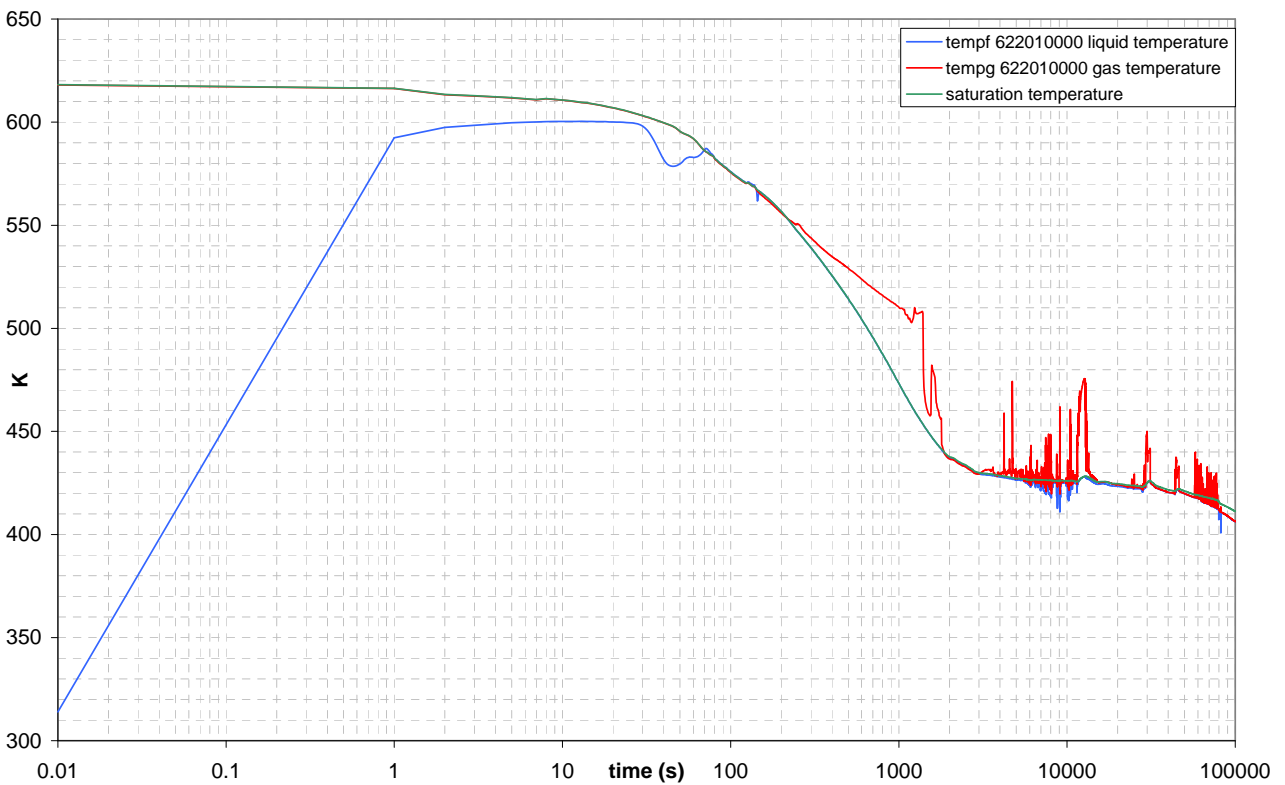

Figure 5.42: EBT SPLIT BREAK LINE liquid and gas temperatures UPSTREAM

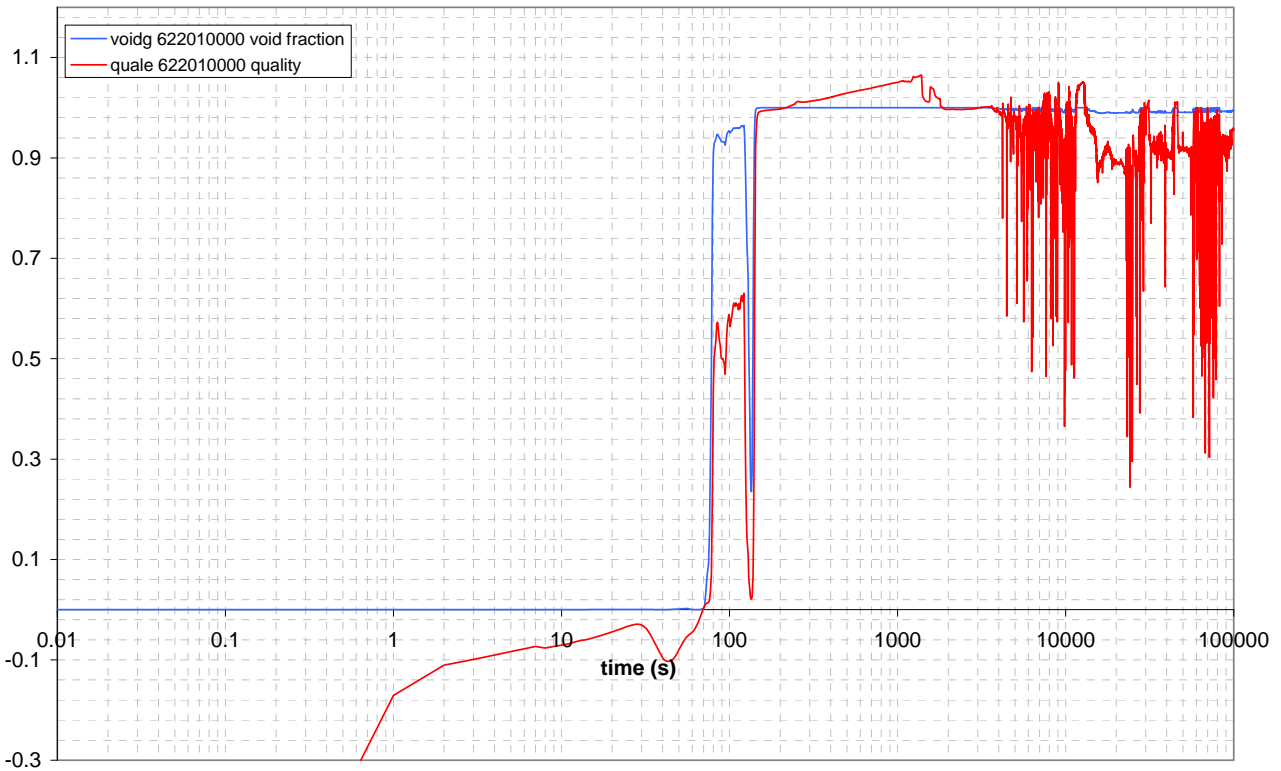

Figure 5.43: EBT SPLIT BREAK LINE void fraction and quality UPSTREAM

Table 5.17: Maximum and minimum values of the main variables in the EBT SPLIT break line upstream of the break

EBT SPLIT break line UPSTREAM		MIN	MAX
void fraction		0.0000	1.0000
volume equilibrium quality		-1.4991	1.0651
mass flowrate	kg/s	-0.0202	4.6686
liquid velocity	m/s	-17.2207	66.6764
gas velocity	m/s	-20.8762	106.1670
liquid temperature	K	314.0370	600.3600
gas temperature	K	406.3700	618.0670
pressure	MPa	0.3417	15.5245

The Table 5.17 shows the minimum and maximum values of void fraction, quality, mass flowrate, liquid and gas velocities, liquid and gas temperatures, pressure during the transient, upstream the break.

DOWNSTREAM

The Figure 5.44, Figure 5.45, Figure 5.46 and Figure 5.47 represent the liquid and gas velocities, the pressure, the liquid and gas temperatures, the void fraction and the quality of the volume 644030000, downstream of the break in the EBT SPLIT line, Figure 4.8. Figure 5.48 shows the volumetric flowrate calculated using the area of the pipe, the void fraction, the gas and liquid velocities.

The mass flowrate is not shown because it is the same downstream and upstream of the break.

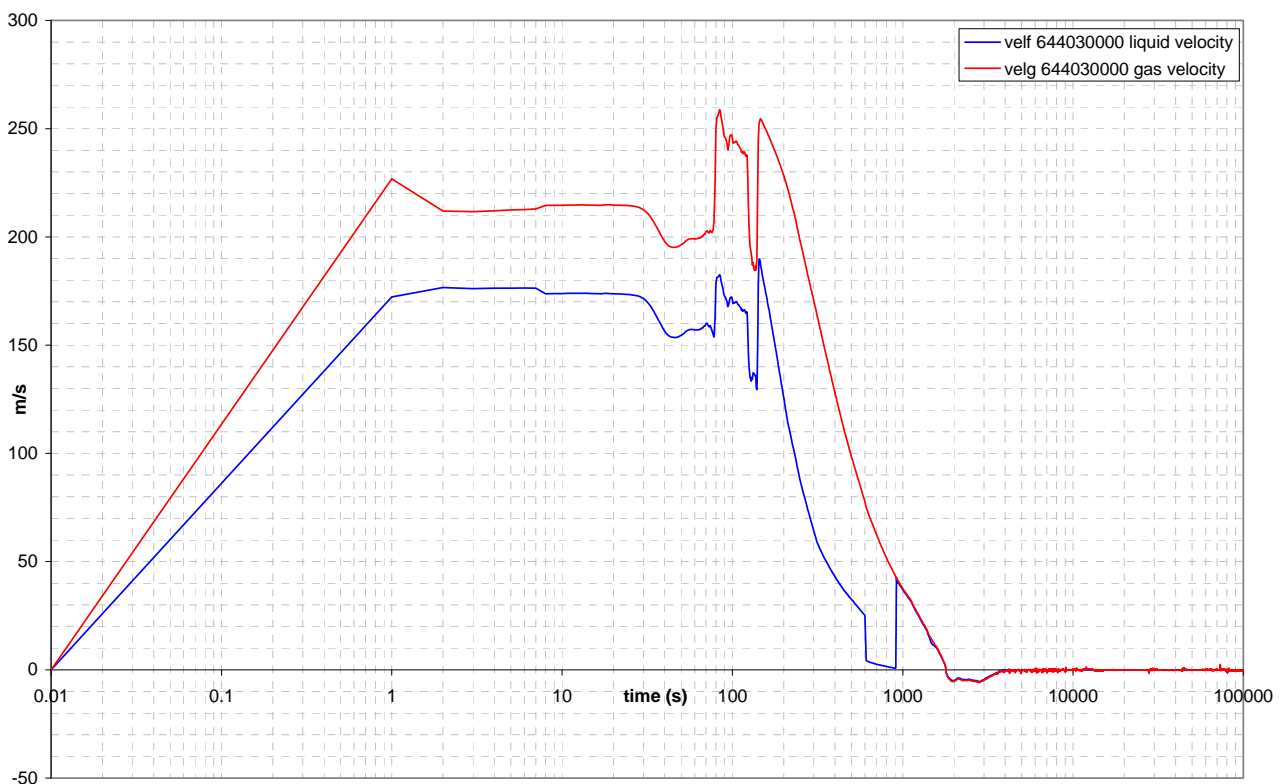

Figure 5.44: EBT SPLIT BREAK LINE liquid and gas velocities DOWNSTREAM

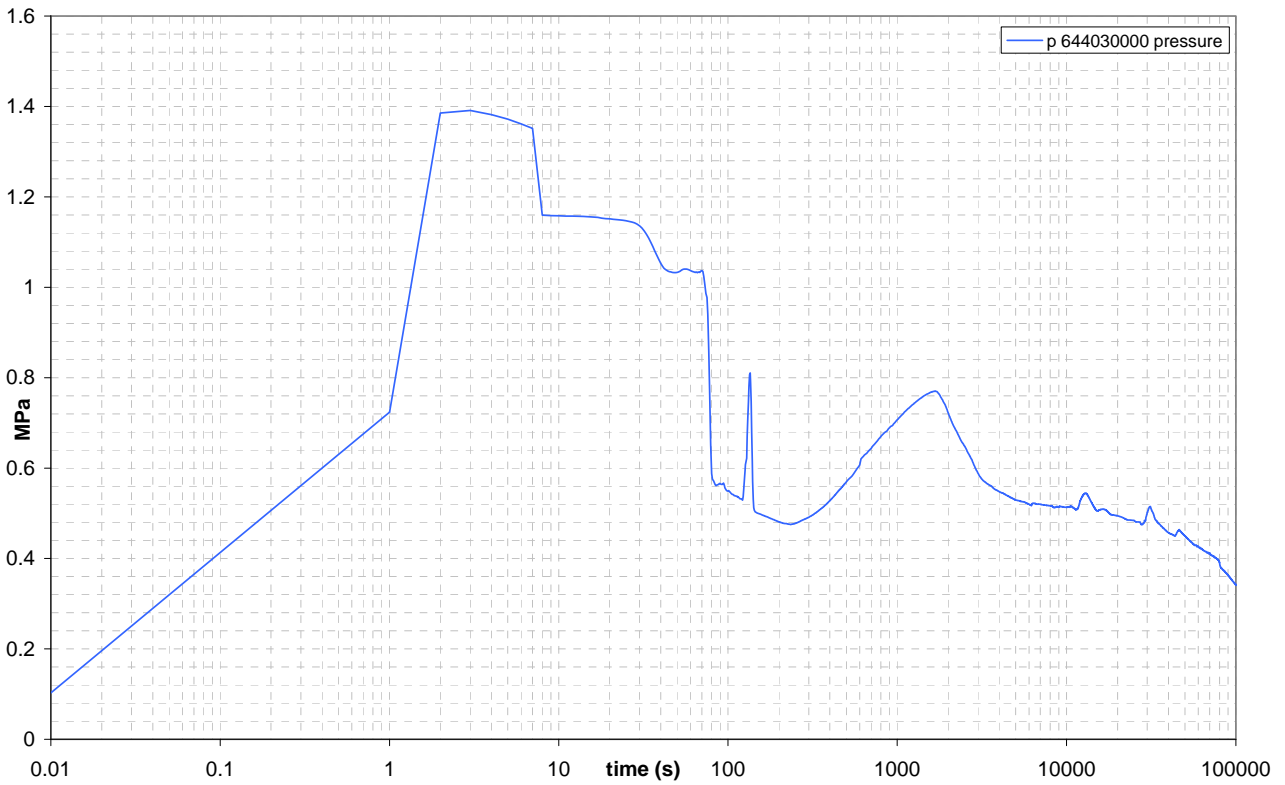

Figure 5.45: EBT SPLIT BREAK LINE pressure DOWNSTREAM

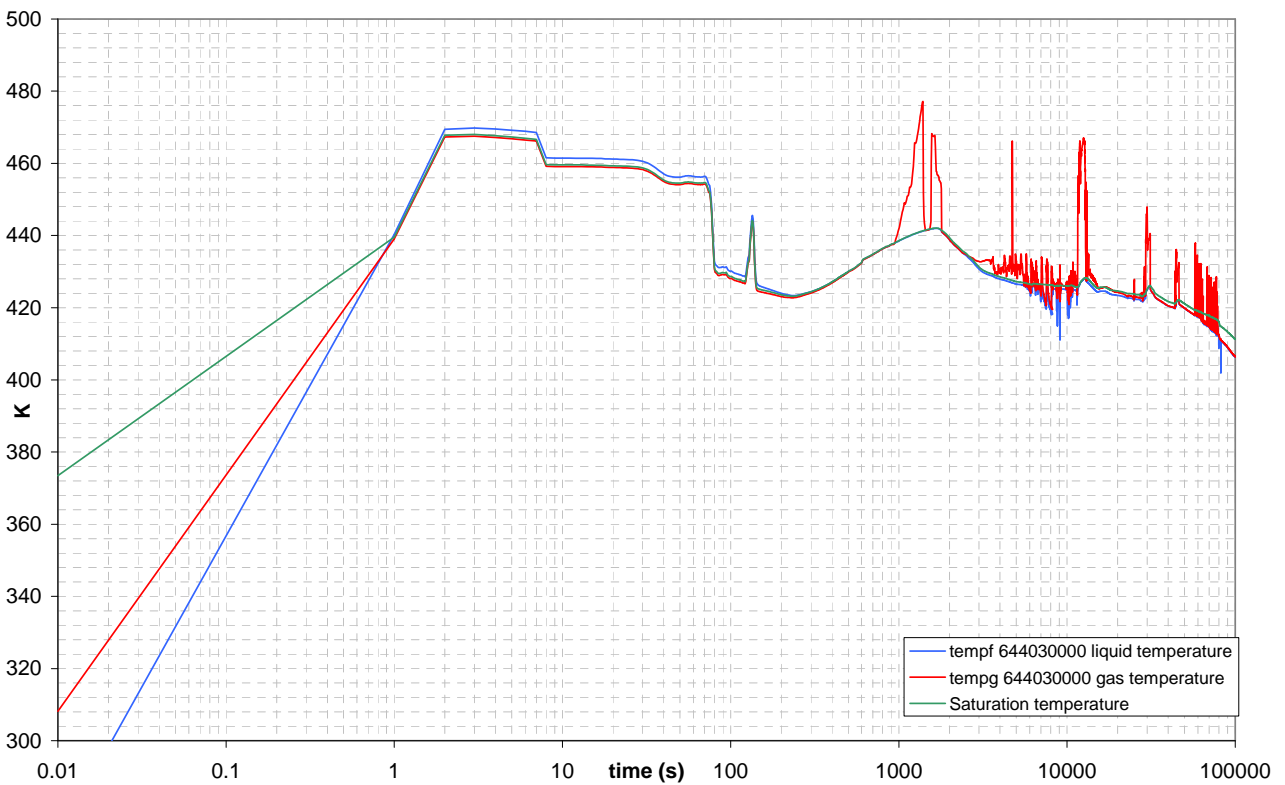

Figure 5.46: EBT SPLIT BREAK LINE liquid and gas temperatures DOWNSTREAM

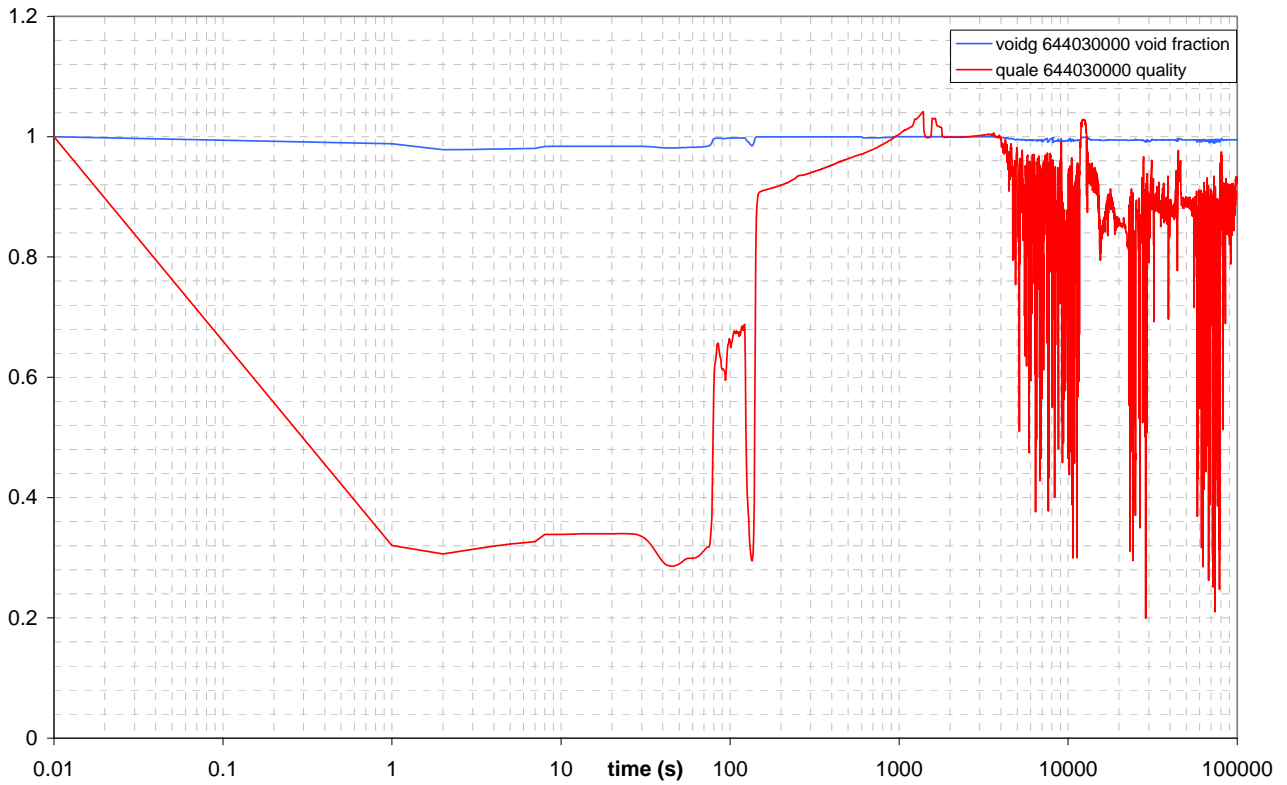

Figure 5.47: EBT SPLIT BREAK LINE void fraction and quality DOWNSTREAM

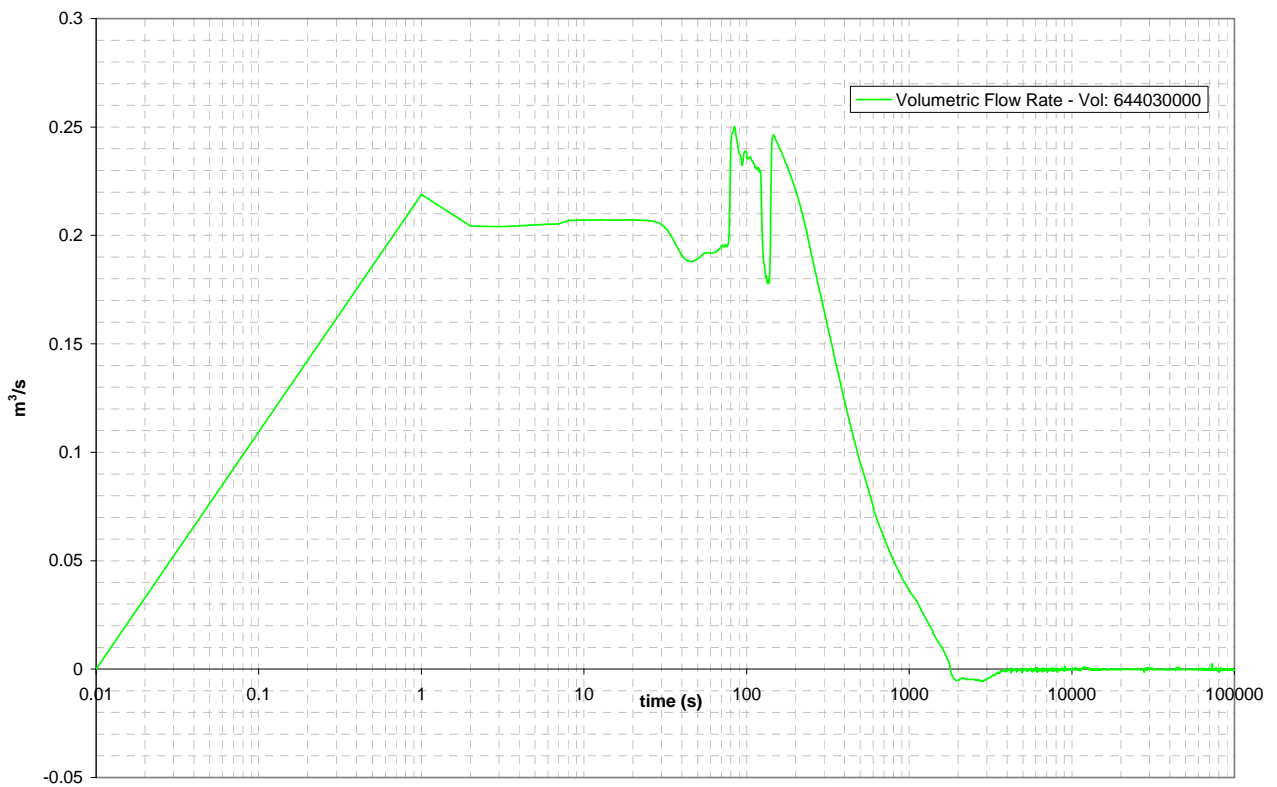

Figure 5.48: EBT SPLIT BREAK LINE volumetric flowrate DOWNSTREAM

The **Errore. L'autoriferimento non è valido per un segnalibro.** shows the minimum and maximum values of void fraction, quality, mass flowrate, liquid and gas velocities, liquid and gas temperatures, pressure and volumetric flowrate during the transient, downstream of the break.

Table 5.18: Maximum and minimum values of the main variables in the
 EBT SPLIT break line downstream the break

EBT SPLIT break line DOWNSTREAM		MIN	MAX
void fraction		0.978	1
volume equilibrium quality		0.19924	1.04125
mass flowrate	kg/s	-0.02	4.668
liquid velocity	m/s	-5.692	189.771
gas velocity	m/s	-5.928	258.755
liquid temperature	K	401.89	469.76
gas temperature	K	406.42	477.11
pressure	MPa	0.10245	1.39122
volumetric flowrate	m ³ /s	-0.006	0.250

The Table 5.19 describes the flow regimes indicated by the nodalization in the volume before the break and in some volumes after the break. The time step changes only when there is a modification in the flow regime. The volumes highlighted in red indicate the monitoring points.

FLOW REGIME

Table 5.19: Flow regimes function of monitoring volumes and time – EBT SPLIT LINE

Time	622010000	644010000	644030000	644070000	645010000
0	BBY	CHF MPR	CHF MPR	CHF MPR	CHF MPR
78	BBY	ANM	ANM	ANM	ANM
79	SLG	ANM	ANM	ANM	ANM
125	ANM	ANM	ANM	ANM	ANM
130	SLG	ANM	ANM	ANM	ANM
137	BBY	ANM	ANM	ANM	ANM
139	SLG	ANM	ANM	ANM	ANM
159	ANM	ANM	ANM	ANM	ANM
550	CHF MPR	ANM	ANM	ANM	ANM
850	CHF MPR	ANM	ANM	ANM	HST
910	CHF MPR	CHF MPR	ANM	ANM	HST
1150	CHF MPR	CHF MPR	CHF MPR	CHF MPR	HST
1620	CHF MPR	CHF MPR	HST	HST	HST
1790	CHF MPR	HST	HST	HST	HST
1820	CHF MPR	CHF MPR	CHF MPR	CHF MPR	CHF MPR
1830	HST	HST	CHF MPR	CHF MPR	CHF MPR
2470	HST	HST	HST	HST	HST
3870	HST	HST	HST	HST	CHF MPR
6190	HST	HST	HST	HST	HST
6200	HST	HST	HST	HST	CHF MPR
7500	HST	HST	HST	HST	HST
8050	HST	HST/ CHF MPR	HST	HST	HST
8070	CHF MPR	HST/ CHF MPR	HST	HST	HST
10830	HST	HST	HST	HST	HST
10840	HST	HST	HST	HST	CHF MPR
99990	HST	HST	HST	HST	HST

5.2.2.1 Synthesis of achievements for the EBT SPLIT break

As indicated by Figure 5.41 and Table 5.17, pressure upstream of the break is very high (15.5 MPa), at least at the beginning of the transient, whereas pressure downstream of the break reaches at maximum 1.39 MPa, as shown in Figure 5.45. Therefore the installation of an eventual spool piece is suggested downstream of the break.

The mass flowrate in the EBT SPLIT break line is large, with the maximum value of 4.67 Kg/s, as shown in Figure 5.39.

Being the EBT SPLIT break line directly connected to the RV, water side, during the early phases of the transient is crossed by subcooled water that get saturated soon and then is replaced by steam. Due to the critical flow that occurs at the break orifice, the void fraction downstream of the break is always high, around 0.98, as indicated in Figure 5.47.

Anyway, for the above described phases of the transient [4], the installation of a spool piece is planned for the EBT SPLIT line. The device will be located downstream of the break in the zone corresponding to volume 644030000 of the nodalization, Figure 4.8. As indicated in Table 5.19, it will experiment three different flow regimes: annular mist, mist pre-CHF and horizontal stratified.

For the EBT SPLIT break line, a Venturi meter will be installed upstream of the break.

5.2.3 ADS lines

As detailed in [4], both the ADS Stage-I lines are opened on contemporary signals of high containment pressure and low PRZ pressure. The ADS Stage-I lines opening helps to reduce pressure in the RV and anticipates the safety systems intervention to make-up water in the primary side. The ADS Stage-II lines open later in the transient, on a low LGMS mass signal, to improve the steam circulation between primary and containment systems in the upper part of the plant.

When the ADS Stage-I valves open, steam flows rapidly through the pipes sucking and entraining water from the PRZ. In this condition, a liquid fraction can flow through the pipes even if they are connected to the RV top, where steam is currently present.

The Table 5.20 describes the maximum and minimum values of mass flowrate and void fraction in the ADS single train and double train (stage I and II) during the EBT break test. As the analysis of the DVI break case has stated the need of a spool piece on both the ST and DT Stage-I pipes, data from the EBT break represent further information on the measurable quantity ranges.

Table 5.20: Maximum and minimum values of the void fraction and mass flow in the ADS ST and DT (stage I and II) upstream and downstream of the valve (EBT test)

EBT break test		Volume	MIN	MAX
ADS ST stage I	Void Fraction	152030000 Upstr.	0	1
ADS ST stage II	Void Fraction	135020000	0	1
ADS DT stage I	Void Fraction	142080000	0.7260	1
ADS DT stage II	Void Fraction	132020000	0.1098	1
ADS ST stage I	Void Fraction	134010000 Downst.	0.95194	1
ADS ST stage II	Void Fraction	155010000	0.98568	1
ADS DT stage I	Void Fraction	131010000	0.94893	1
ADS DT stage II	Void Fraction	145010000	0.99273	1
ADS ST stage I	Mass Flow kg/s	153000000	-0.0024	0.9577
ADS ST stage II	Mass Flow kg/s	154000000	-0.0067	0.0109
ADS DT stage I	Mass Flow kg/s	143000000	-0.0036	1.9801
ADS DT stage II	Mass Flow kg/s	144000000	-0.0209	0.0145

The Figure 5.49 and Figure 5.50 represent the void fraction trend in the ADS ST Stage-I line upstream and downstream of the break and Figure 5.51 represents the mass flow.

Figure 5.52, Figure 5.53 and Figure 5.54 show the same variables in the ADS DT Stage-I line. The involved volumes are 152080000 (upstream) and 134010000 (downstream) for the ST and 142080000 (upstream) and 131010000 (downstream) for the DT, Figure 4.15, Figure 4.16, Figure 4.17. Figure 5.55 and Figure 5.56 show the volumetric flowrate calculated using the area of the pipe, the void fraction, the gas and liquid velocities.

5.2.3.1 Synthesis of achievements for the ADS lines

ADS Stage-I

Table 5.20 shows that the mass flow is appreciable in the ADS ST and DT Stage-I and in the ADS DT Stage-I. For this break test, the void fraction in the ADS lines is close to 1 for the whole transient. Anyway, following the DVI break case analysis, a spool piece is foreseen on each line. The devices will be located downstream of the valves in zones corresponding to volumes 134010000 and 131010000 for the ST and DT, respectively. Table 5.21 and

Table 5.22 show the minimum and maximum values (mass and volumetric flowrate, quality, void fraction, temperature, pressure, liquid and gas velocities) in these volumes that are necessary to set the spool piece.

A Venturi meter will be installed upstream of the ADS ST and DT Stage-I valves.

ADS Stage-II

Table 5.20 shows that the mass flow is very little in both the ADS ST and DT Stage-II and also the void fraction excursions are limited around 1. For this reason no spool piece will be installed on such pipes.

A Venturi meter will be installed upstream of the ADS ST and DT Stage-II valves.

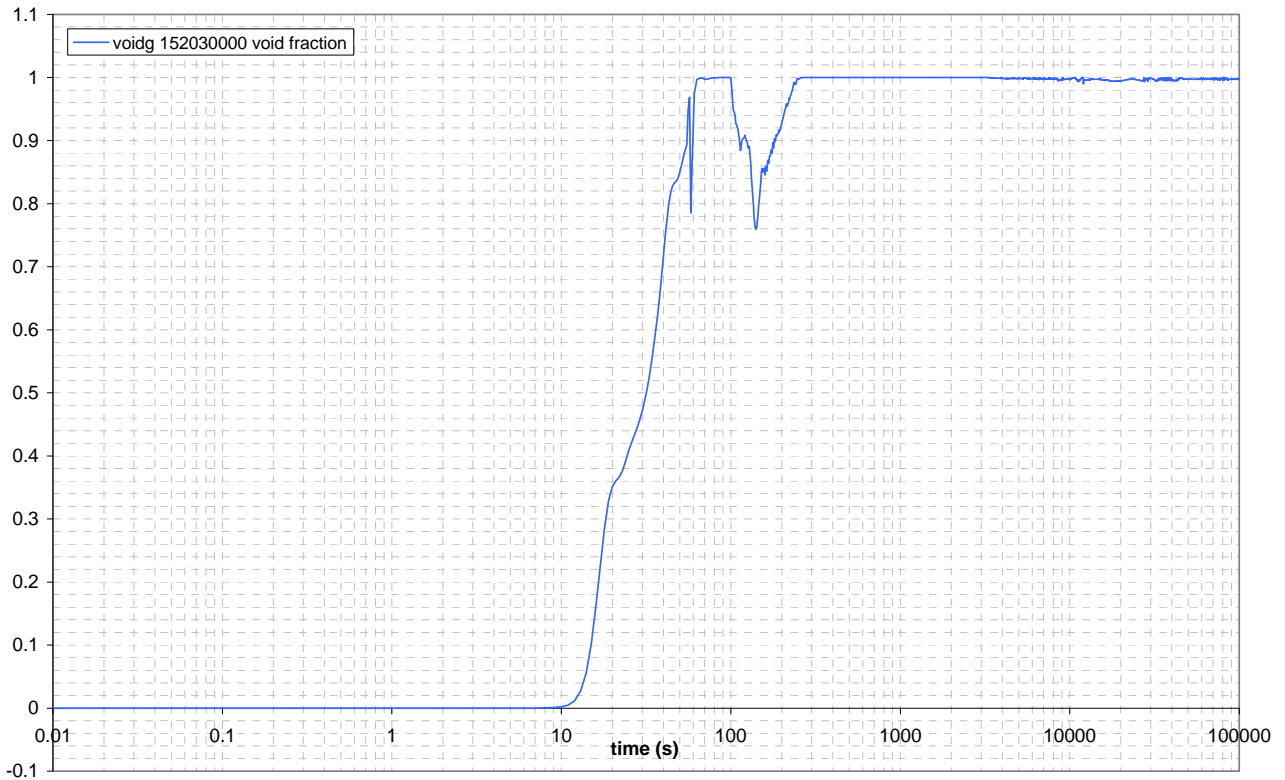

Figure 5.49: EBT TEST, ADS ST (Stage-I) LINE void fraction UPSTREAM

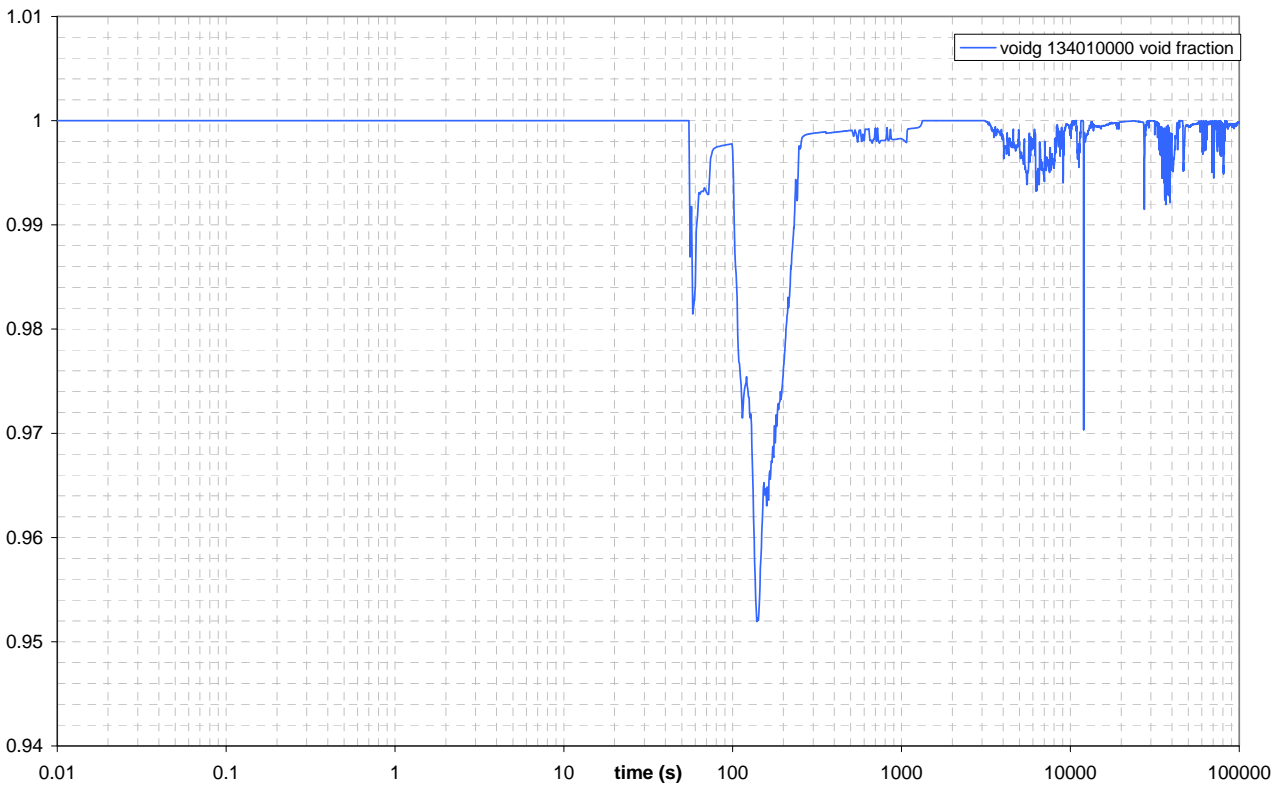

Figure 5.50: EBT TEST, ADS ST (Stage-I) LINE void fraction DOWNSTREAM

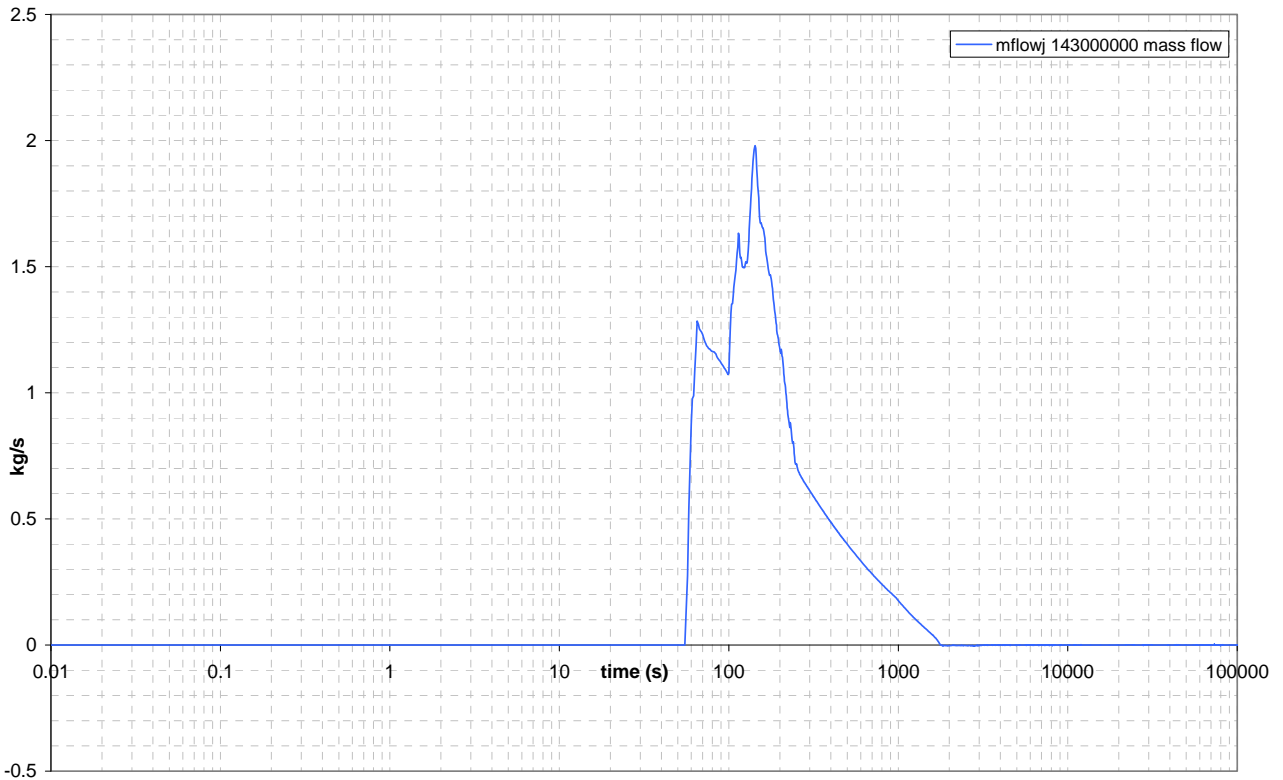

Figure 5.51: EBT TEST, ADS ST (Stage-I) LINE mass flow

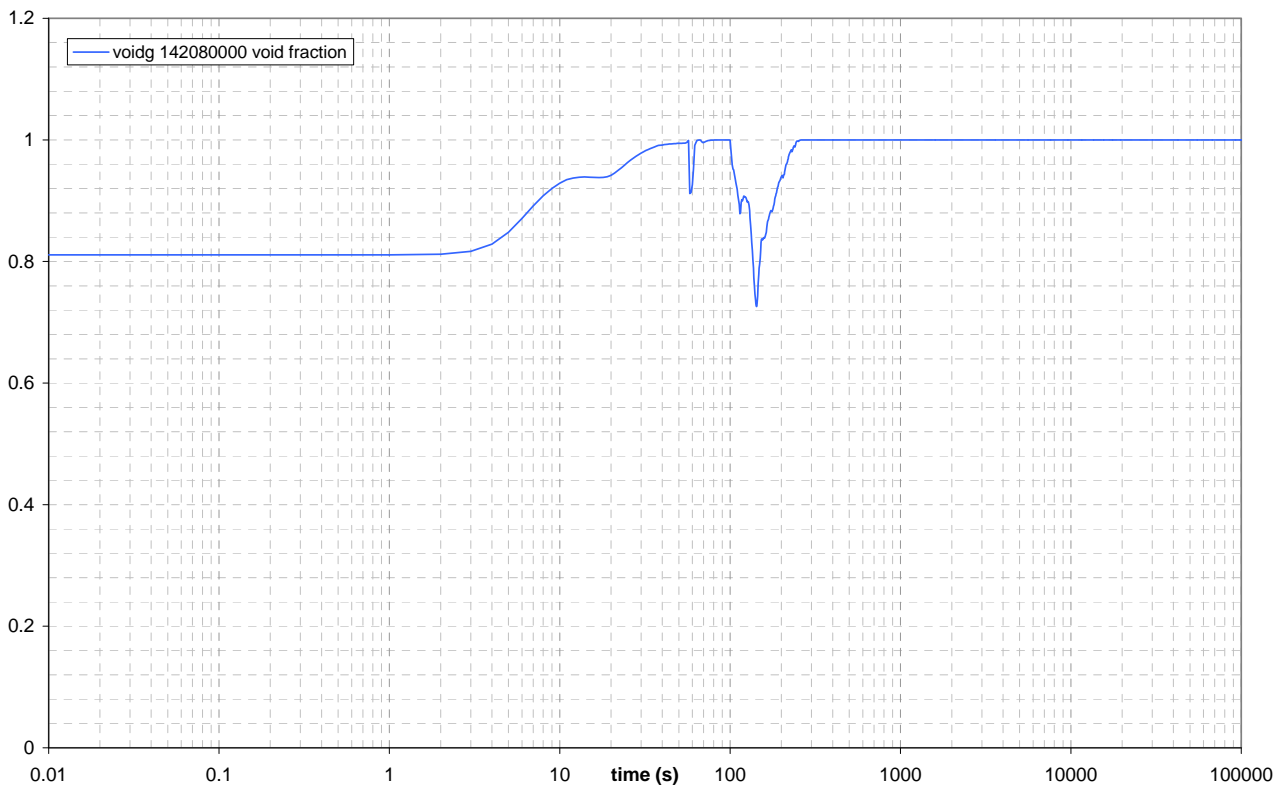

Figure 5.52: EBT TEST, ADS DT (Stage-I) LINE void fraction UPSTREAM



Figure 5.53: EBT TEST, ADS DT (Stage-I) LINE void fraction DOWNSTREAM

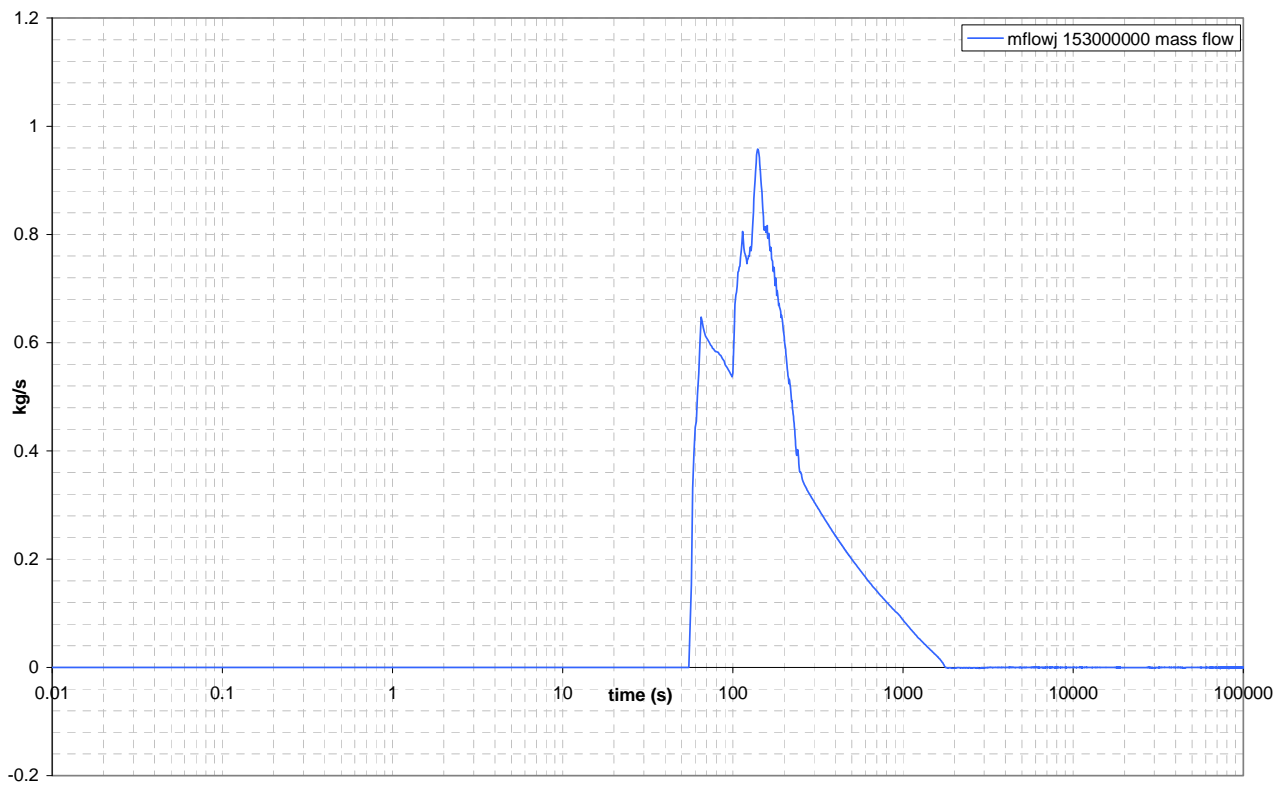

Figure 5.54: EBT TEST, ADS DT (Stage-I) LINE mass flow



Figure 5.55: EBT TEST, ADS ST (Stage-I) LINE volumetric flowrate DOWNSTREAM

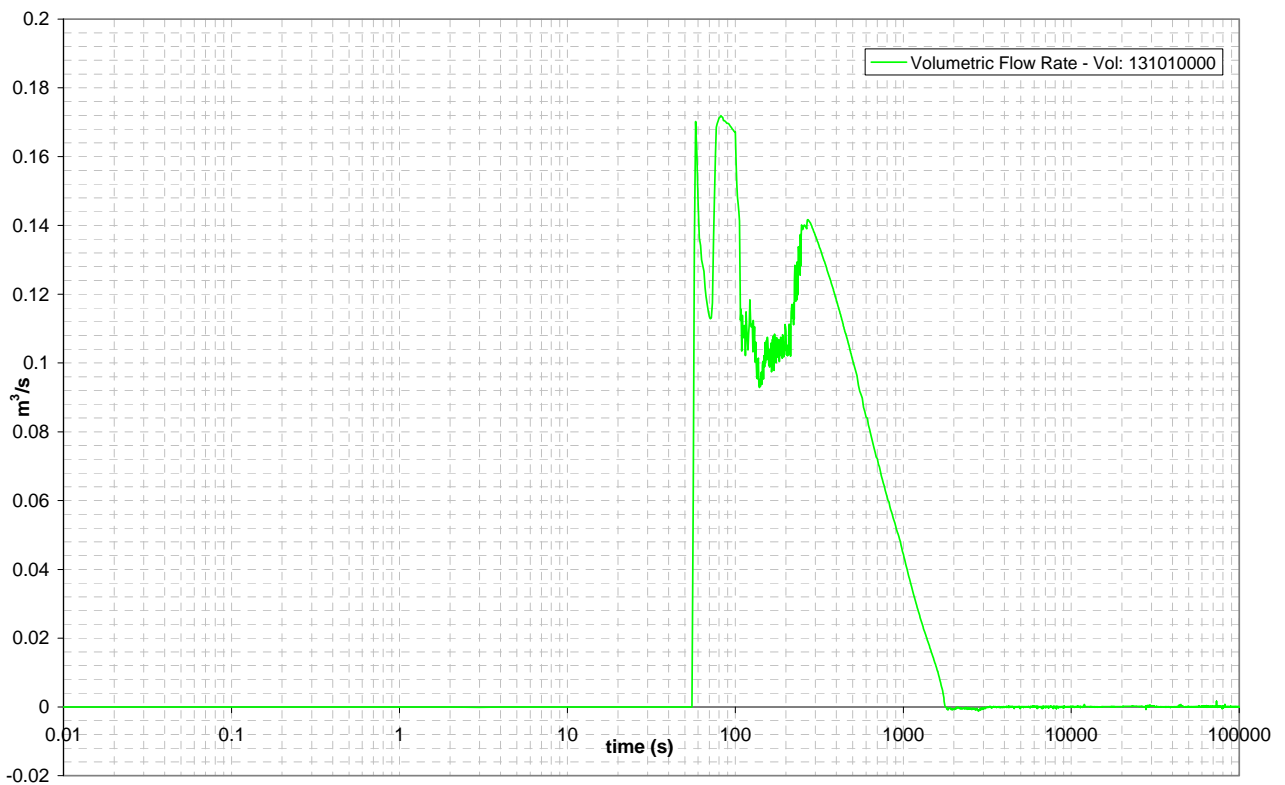

Figure 5.56: EBT TEST, ADS DT (Stage-I) LINE volumetric flowrate DOWNSTREAM

Table 5.21: Maximum and minimum values of the main variables in the ADS ST (Stage-I) downstream of the valve (EBT break test)

EBT break test – ADS ST line DOWNSTREAM		MIN	MAX
void fraction		0.95194	1
volume equilibrium quality		0.0907	1.0510
mass flowrate	kg/s	-0.0024	0.9577
liquid velocity	m/s	-1.2165	25.1173
gas velocity	m/s	-0.9645	61.7132
liquid temperature	K	273.16	487.424
gas temperature	K	309.808	486.337
pressure	MPa	0.1024	2.0505
volumetric flowrate	m ³ /s	-0.001	0.070

Table 5.22: Maximum and minimum values of the main variables in the ADS DT (Stage-I) downstream of the valve (EBT break test)

EBT break test – ADS DT line DOWNSTREAM		MIN	MAX
void fraction		0.94893	1
volume equilibrium quality		0.337865	1.05026
mass flowrate	kg/s	-0.0036	1.98012
liquid velocity	m/s	-0.4353	31.6873
gas velocity	m/s	-0.4353	62.9731
liquid temperature	K	273.16	483.729
gas temperature	K	311.396	485.768
pressure	MPa	0.1024	1.8419
volumetric flowrate	m ³ /s	-0.001	0.172

5.3 ADS BREAK TEST

A Design Basis Event is simulated with a 6 inch equivalent double ended guillotine (DEG) break on the Stage-I of an ADS train (ADS single train in the facility), between the safety valve and the detachment to the ADS Stage-II piping. Differently from the test matrix specification [1], all the safety systems are available: 3 ADS (ST and DT in SPES3), 2 EBT, 4 EHRS, 2 LGMS. Due to the break position, the ADS ST Stage-I is lost.

5.3.1 ADS ST DEG break line

Errore. L'autoriferimento non è valido per un segnalibro. describes the nodalization of the ADS ST DEG BREAK line: one volume upstream of the valve, the junction (valve) that represents the break, five volumes downstream of the valve and the nozzle before the tank (end of line). The main variables and the flow regimes have been taken in the volumes indicated by “*”.

Table 5.23: Description of the volumes for the ADS ST DEG break

UPSTREAM	MOTOR VALVE	DOWNSTREAM	END OF LINE
126010000 (*)	127000000	128010000	129010000
		128020000	
		128030000	
		128040000 (*)	
		128050000	

UPSTREAM

The Figure 5.57, Figure 5.58, Figure 5.59, Figure 5.60 and Figure 5.61 represent the mass flowrate, the liquid and gas velocities, the pressure, the liquid and gas temperatures, the void fraction and the quality of the volume 126010000 upstream the break in the ADS ST DEG line, Figure 4.16.

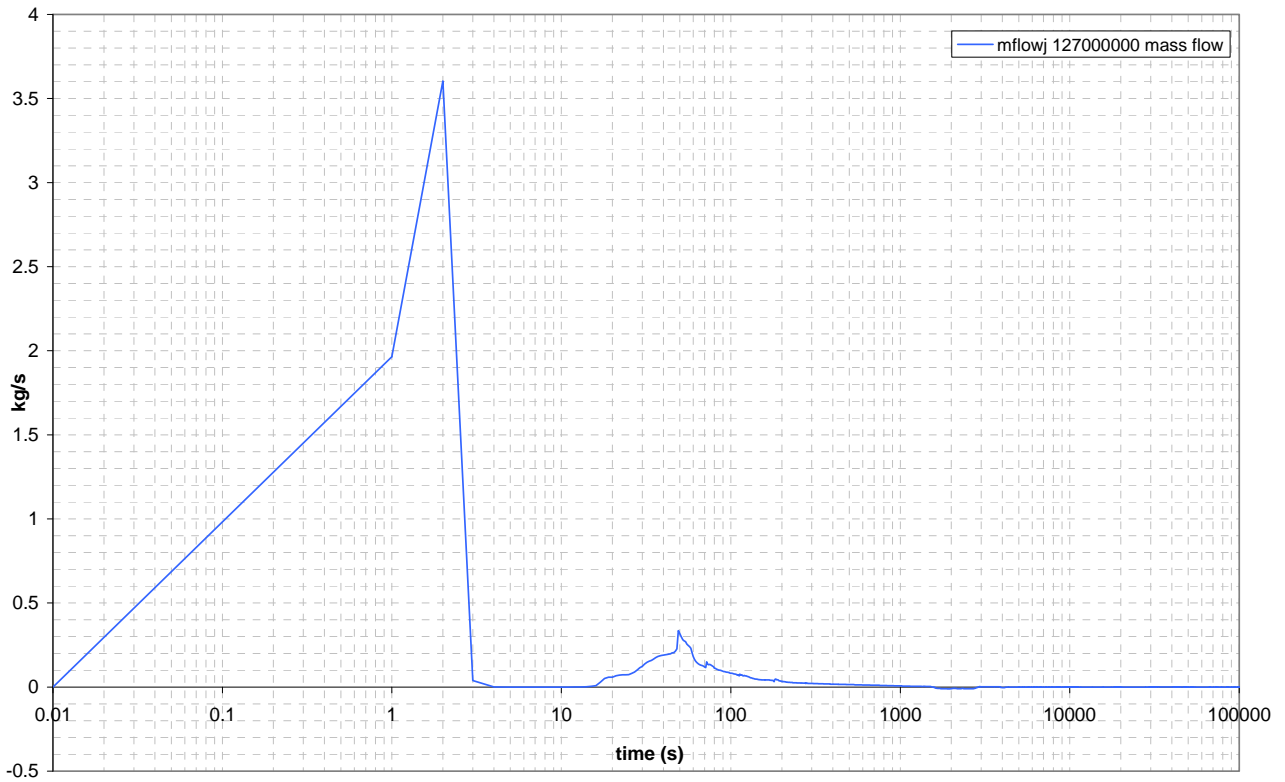

Figure 5.57: ADS ST DEG BREAK LINE mass flowrate

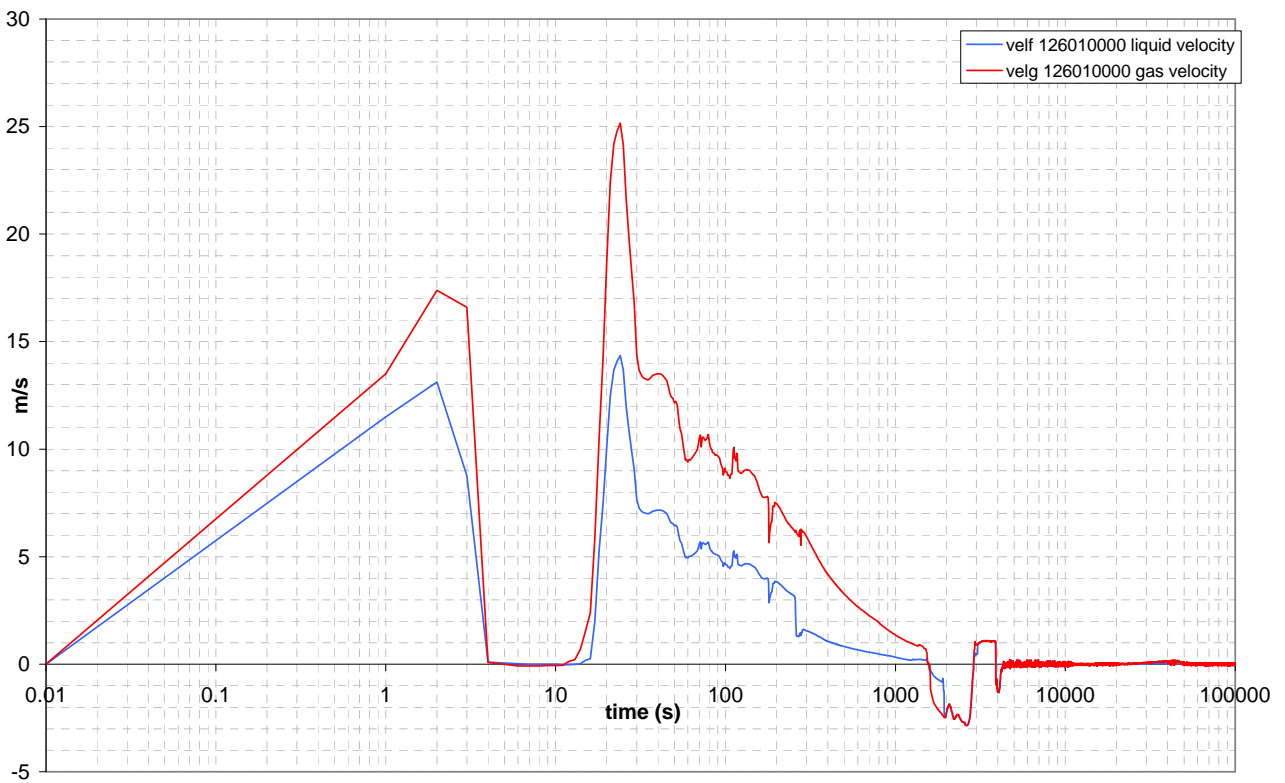

Figure 5.58: ADS ST DEG BREAK LINE liquid and gas velocities UPSTREAM

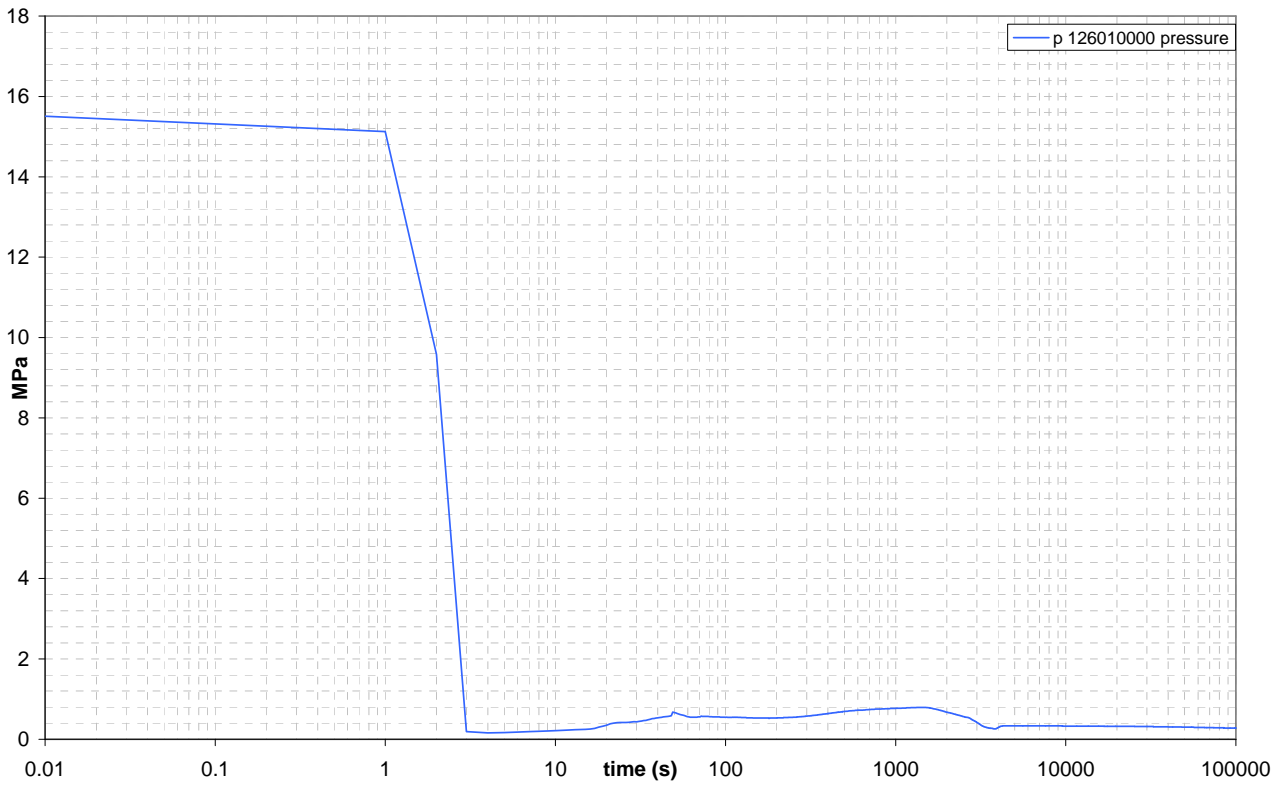

Figure 5.59: ADS ST DEG BREAK LINE pressure UPSTREAM

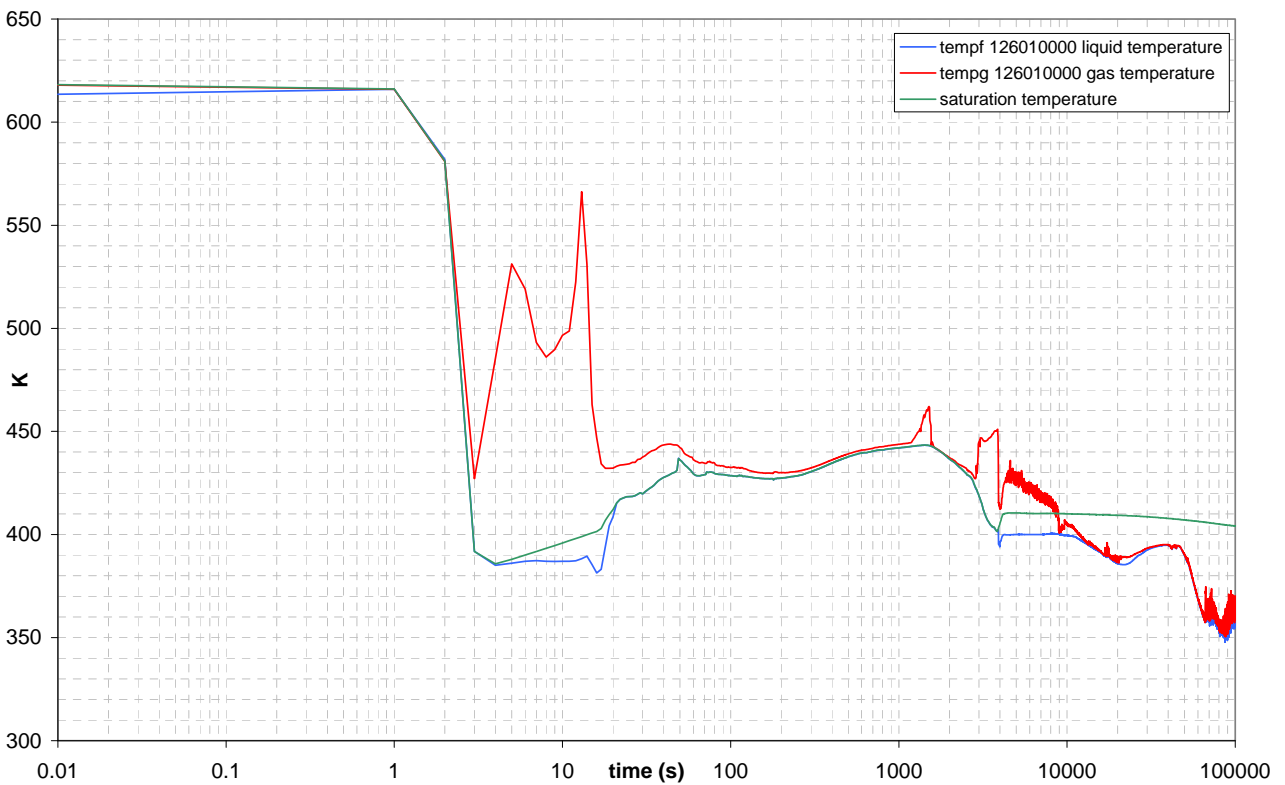

Figure 5.60: ADS ST DEG BREAK LINE liquid and gas temperatures UPSTREAM

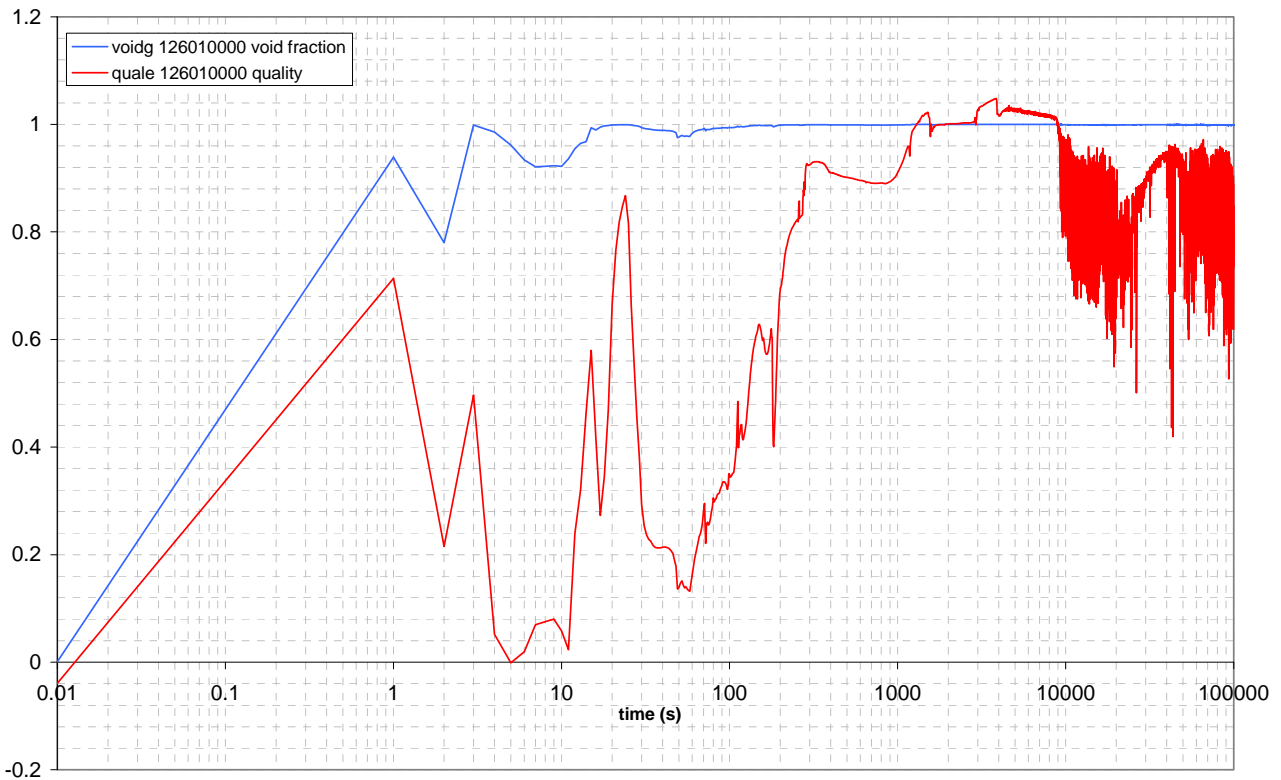

Figure 5.61: ADS ST DEG BREAK LINE void fraction and quality UPSTREAM

Table 5.24: Maximum and minimum values of the main variables in the ADS ST DEG break line upstream of the valve

ADS DEG break line UPSTREAM		MIN	MAX
void fraction		0.0008**	1.0000
volume equilibrium quality		0.0	1.0
mass flowrate	kg/s	-0.0102	3.6046
liquid velocity	m/s	-2.8502	14.3460
gas velocity	m/s	-2.8502	25.1588
liquid temperature	K	347.6950	615.9080
gas temperature	K	350.4220	617.9740
pressure	MPa	0.1563	15.5067

** This value is due to a water plug formed upstream of the break caused by steam condensation in the steady state. The plug is outright ejected when the valve opens, then the void fraction reaches the minimum value of 0.77 for both the lines.

The Table 5.24 shows the minimum and maximum values of void fraction, quality, mass flowrate, liquid and gas velocities, liquid and gas temperatures, pressure during the transient, upstream of the break.

DOWNSTREAM

The Figure 5.62, Figure 5.63, Figure 5.64 and Figure 5.65 represent the liquid and gas velocities, the pressure, the liquid and gas temperatures, the void fraction and the quality of the volume 128040000, downstream of the break in the ADS ST DEG line, Figure 4.16. Figure 5.66 shows the volumetric flowrate calculated using the area of the pipe, the void fraction, the gas and liquid velocities.

The mass flowrate is not shown because it is the same downstream and upstream of the break.

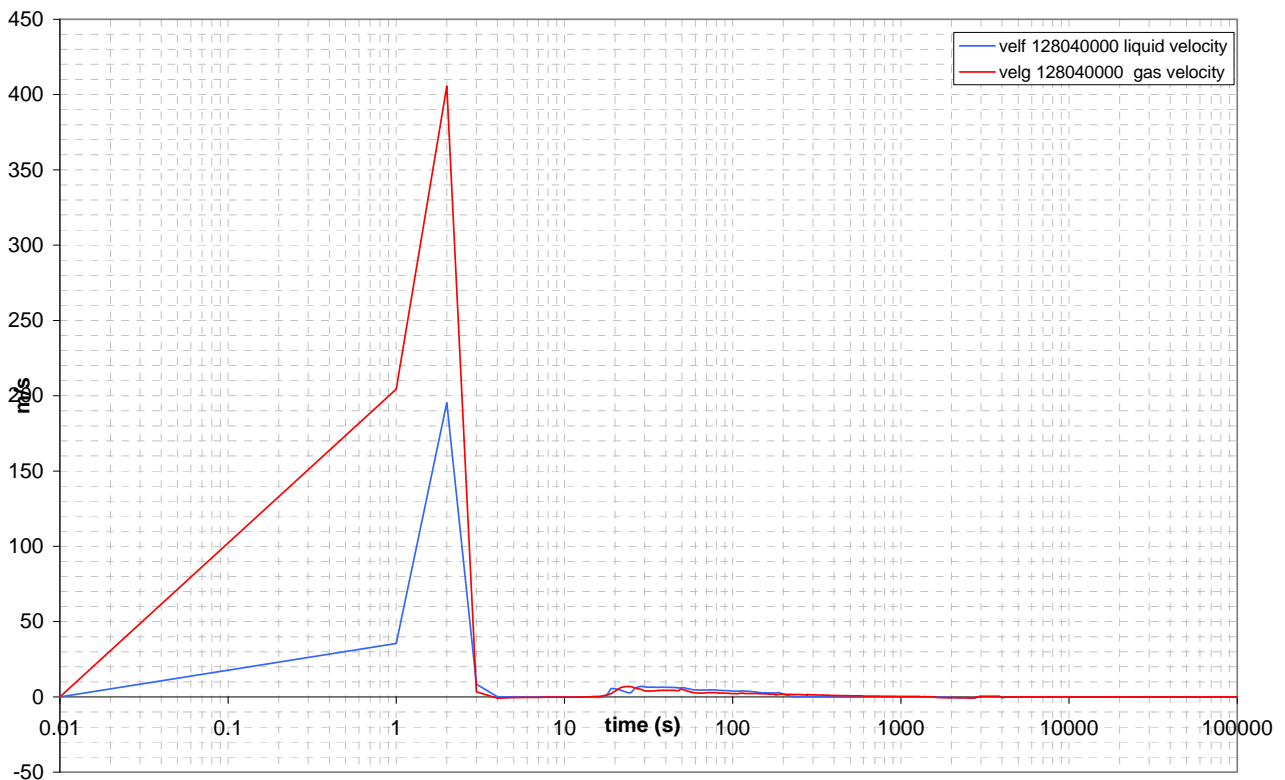

Figure 5.62: ADS ST DEG BREAK LINE liquid and gas velocities DOWNSTREAM

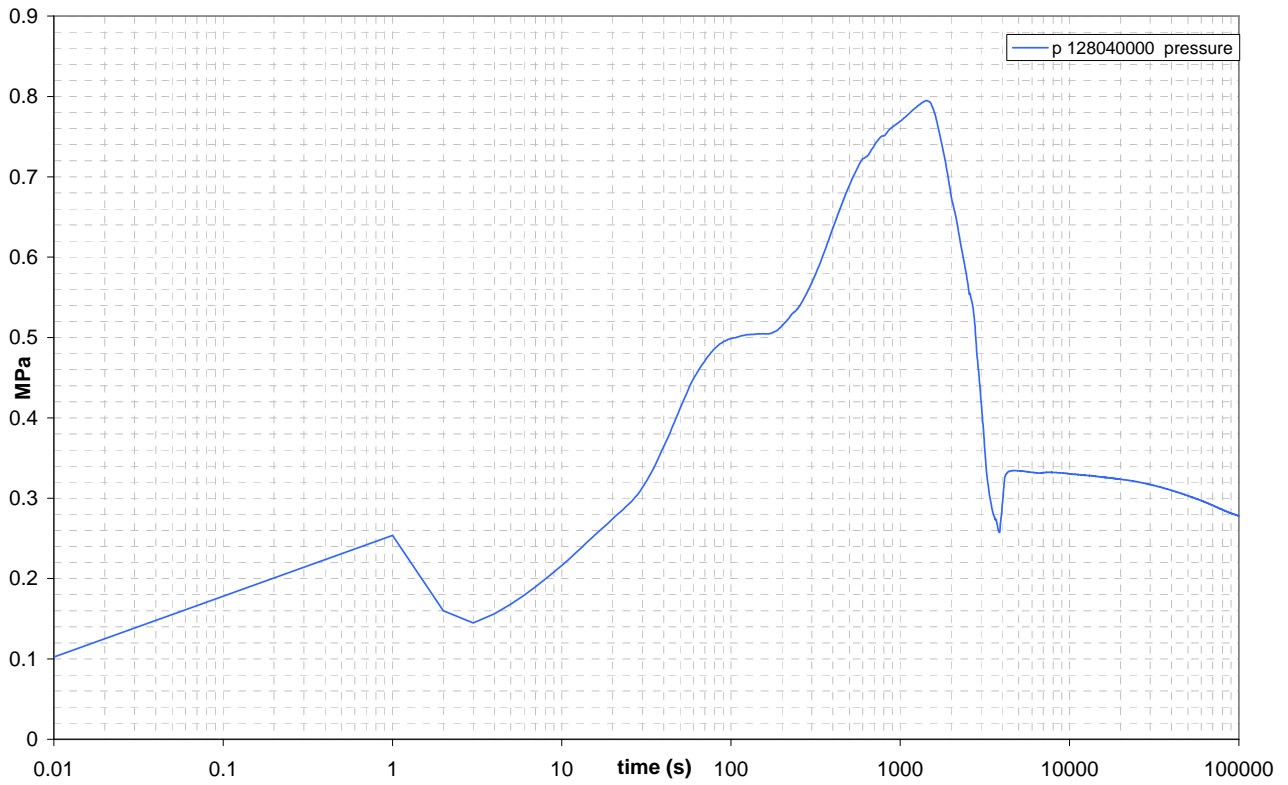

Figure 5.63: ADS ST DEG BREAK LINE pressure DOWNSTREAM

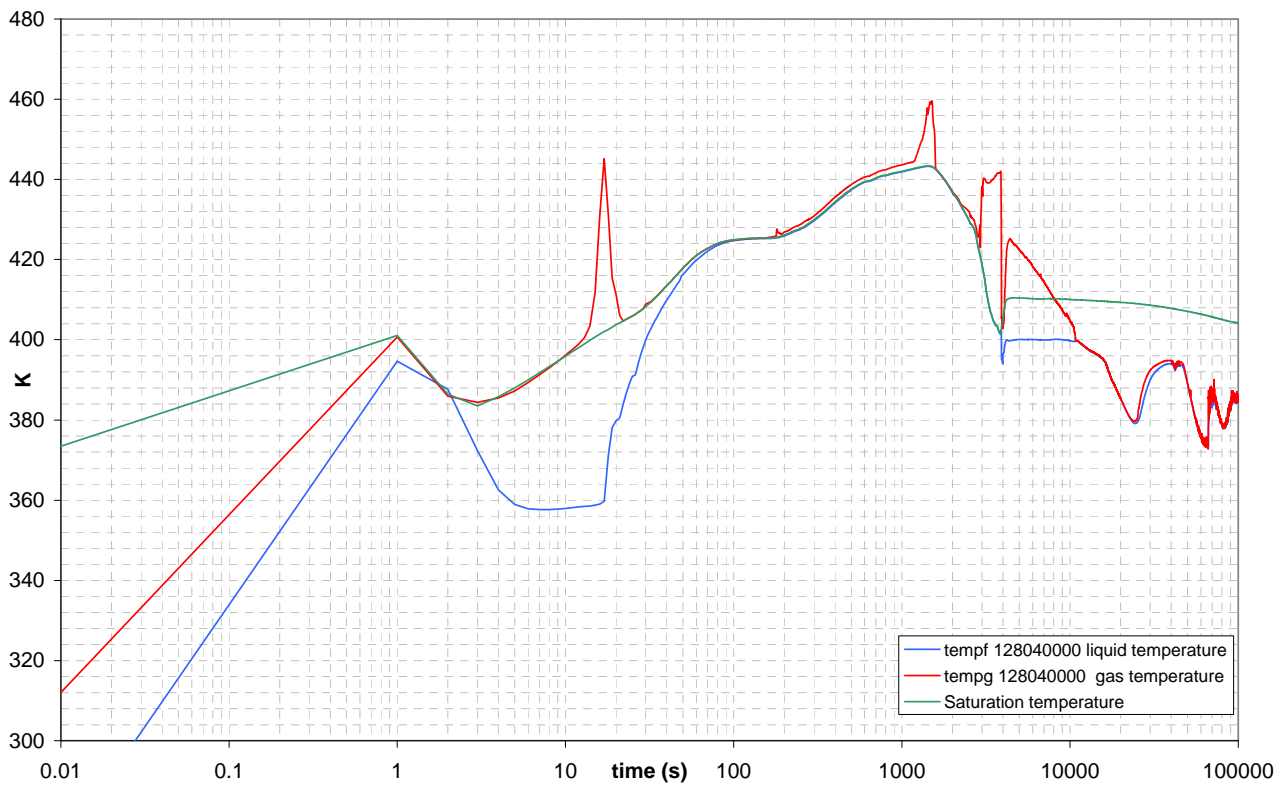

Figure 5.64: ADS ST DEG BREAK LINE liquid and gas temperatures DOWNSTREAM

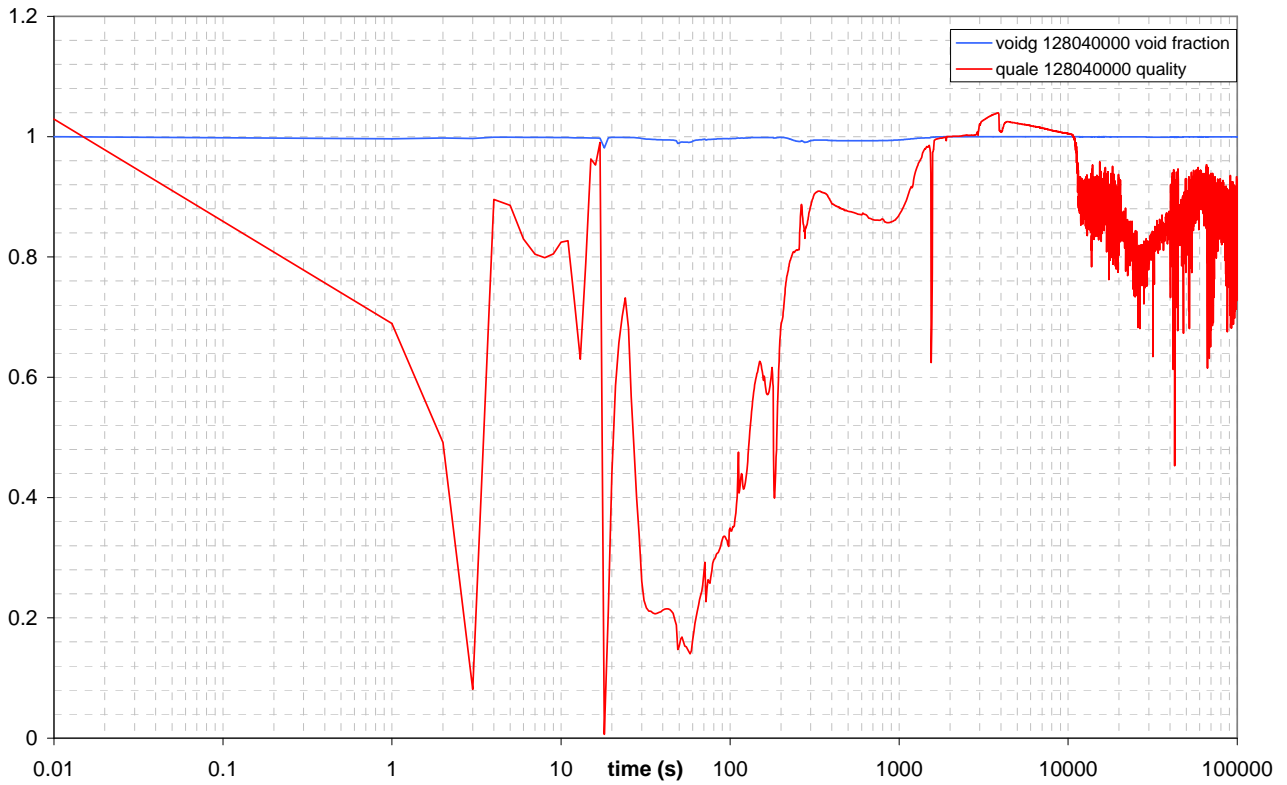

Figure 5.65: ADS ST DEG BREAK LINE void fraction and quality DOWNSTREAM

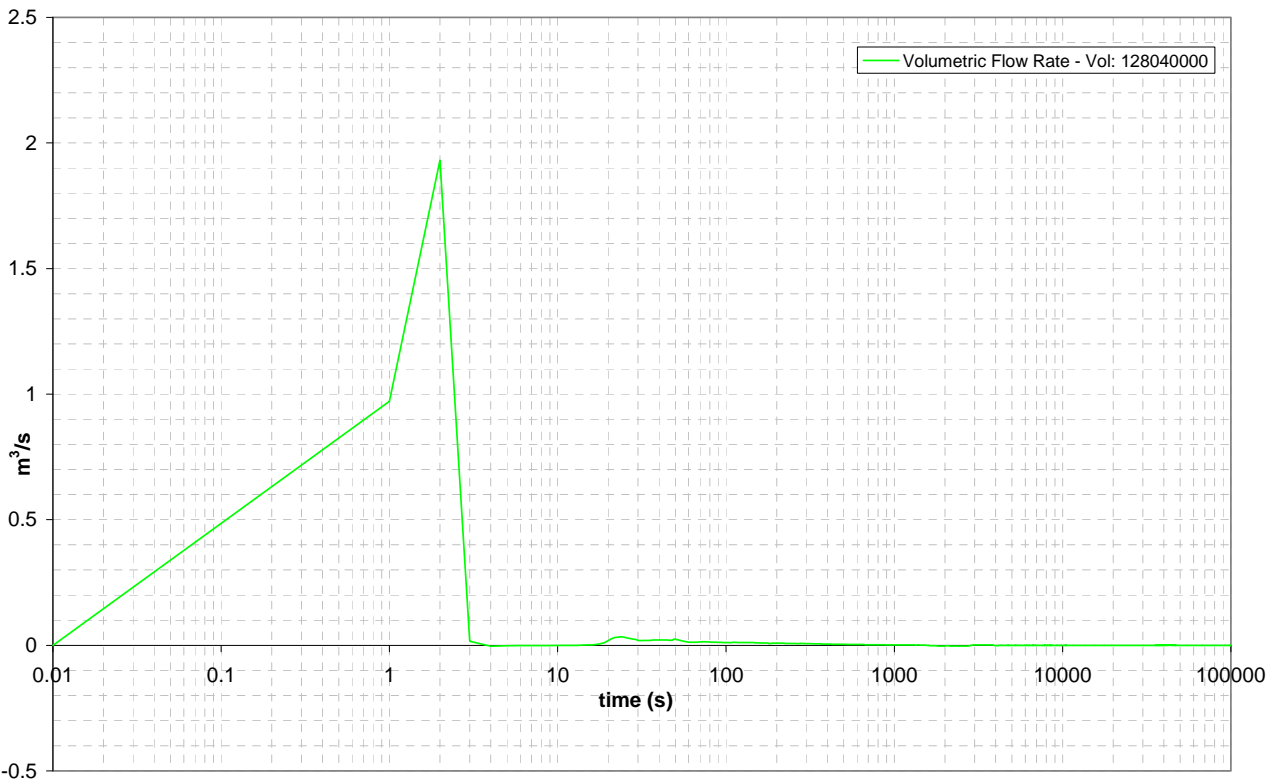

Figure 5.66: ADS ST DEG BREAK LINE volumetric flowrate DOWNSTREAM

The **Errore. L'autoriferimento non è valido per un segnalibro.** shows the minimum and maximum values of void fraction, quality, mass flowrate, liquid and gas velocities, liquid and gas temperatures, pressure and volumetric flowrate during the transient, downstream of the break.

Table 5.25: Maximum and minimum values of the main variables in the
ADS ST DEG break line downstream of the break

ADS DEG break line DOWNSTREAM		MIN	MAX
void fraction		0.981	1
volume equilibrium quality		0.00639	1.0396
mass flowrate	kg/s	-0.0102	3.6046
liquid velocity	m/s	-0.679	195269
gas velocity	m/s	-0.820	405.494
liquid temperature	K	357.62	443.26
gas temperature	K	372.82	459.58
pressure	MPa	0.1024	0.7948
volumetric flowrate	m ³ /s	-0.004	1.931

The Table 5.26 describes the flow regimes in the volume before the break and in some volumes after the break. The time step changes only when there is a modification in the flow regime. The volumes highlighted in red indicate the monitoring points.

FLOW REGIMES

Table 5.26: Flow regimes function of monitoring volumes and time – ADS ST DEG LINE

Time	126010000	128010000	128040000	128050000	129010000
0	BBY	CHF MPR	CHF MPR	CHF MPR	CHF MPR
1	ANM	ANM	ANM	ANM	ANM
2	SLG	ANM	ANM	ANM	ANM
2120	HST	HST	HST	HST	HST
2130	CHF MPR	CHF MPR	HST	HST	HST
2220	CHF MPR	CHF MPR	CHF MPR	CHF MPR	CHF MPR
2250	CHF MPR	CHF MPR	HST	HST	HST
2260	CHF MPR	CHF MPR	CHF MPR	HST	HST
2880	CHF MPR	CHF MPR	CHF MPR	CHF MPR	CHF MPR
2890	HST	CHF MPR	CHF MPR	CHF MPR	CHF MPR
2900	HST	HST	CHF MPR	CHF MPR	CHF MPR
2910	HST	HST	CHF MPR	CHF MPR	CHF MPR
2920	HST	HST	HST	HST/ CHF MPR	CHF MPR
2930	HST	HST	HST	HST/ CHF MPR	HST
2950	HST	HST	HST	HST/ CHF MPR	CHF MPR
3040	HST	HST	CHF MPR	HST/ CHF MPR	CHF MPR
3770	CHF MPR	CHF MPR	CHF MPR	HST/ CHF MPR	CHF MPR
3910	CHF MPR	CHF MPR	CHF MPR	HST/ CHF MPR	HST/ CHF MPR
8810	CHF MPR	CHF MPR	CHF MPR	CHF MPR	HST/ CHF MPR
8820	CHF MPR	HST	CHF MPR	CHF MPR	HST/ CHF MPR
8830	HST	HST	CHF MPR	CHF MPR	HST/ CHF MPR
8840	CHF MPR	HST	CHF MPR	CHF MPR	HST/ CHF MPR
9860	HST	HST	CHF MPR	CHF MPR	HST/ CHF MPR
10490	HST	HST	CHF MPR	CHF MPR	HST/ CHF MPR
10500	HST	HST	HST	CHF MPR	HST/ CHF MPR
10510	HST	HST	CHF MPR	CHF MPR	HST/ CHF MPR
10750	HST	HST	HST	CHF MPR	HST/ CHF MPR
10890	HST	HST	HST	HST/ CHF MPR	HST/ CHF MPR
11250	HST	HST	HST	HST	HST/ CHF MPR
99990	HST	HST	HST	HST	HST

5.3.1.1 Synthesis of achievements for the ADS ST DEG break

As indicated by Figure 5.59 and Table 5.24, pressure upstream of the break is very high (15.5 MPa), at least at the beginning of the transient, whereas pressure downstream of the break reaches a maximum of 0.79 MPa, as shown in Figure 5.63. Therefore the installation of an eventual spool piece is suggested downstream of the break.

Upstream of the break, the void fraction varies between 0.8 and 1, as indicated in Figure 5.61 and Table 5.24. Downstream of the break the void fraction is always high, between 0.981 and 1, as shown in Figure 5.65 and The Errore. **L'autoriferimento non è valido per un segnalibro.** shows the minimum and maximum values of void fraction, quality, mass flowrate, liquid and gas velocities, liquid and gas temperatures, pressure and volumetric flowrate during the transient, downstream of the break.

Table 5.25. Moreover, as shown in Figure 5.57, the mass flowrate is appreciable only in the first 3 s of the transient, until the break valve on the ADS ST main line is closed. This is due to the layout of the DEG line and its connection to the upper part of the Dry-Well, where only air or air steam mixture are present during the transient. Consequently, the velocities downstream of the break are very low, as shown in Figure 5.62.

This avoids the need to install a spool piece on the ADS ST DEG break line.

For the ADS ST DEG break line, a Venturi meter will be installed upstream of the break.

5.3.2 ADS SPLIT break line

The

Table 5.27 describes the nodalization of the ADS ST SPLIT BREAK line: one volume upstream the valve, the junction (valve) that represents the break, seven volumes downstream the valve and the nozzle before the tank (end of line). The main variables and the flow regimes have been taken in the volumes indicated by “*”.

Table 5.27: Description of the volumes for the ADS ST SPLIT break

UPSTREAM	MOTOR VALVE	DOWNSTRAM	END OF LINE
157010000 (*)	158000000	133010000	159010000
		133020000	
		133030000	
		133040000 (*)	
		133050000	
		133060000	
		133070000	

UPSTREAM

The Figure 5.67, Figure 5.68, Figure 5.69, Figure 5.70 and Figure 5.71 represent the mass flowrate, the liquid and gas velocities, the pressure, the liquid and gas temperatures, the void fraction and the quality of the volume 157010000 upstream of the break in the ADS SPLIT line, Figure 4.16.

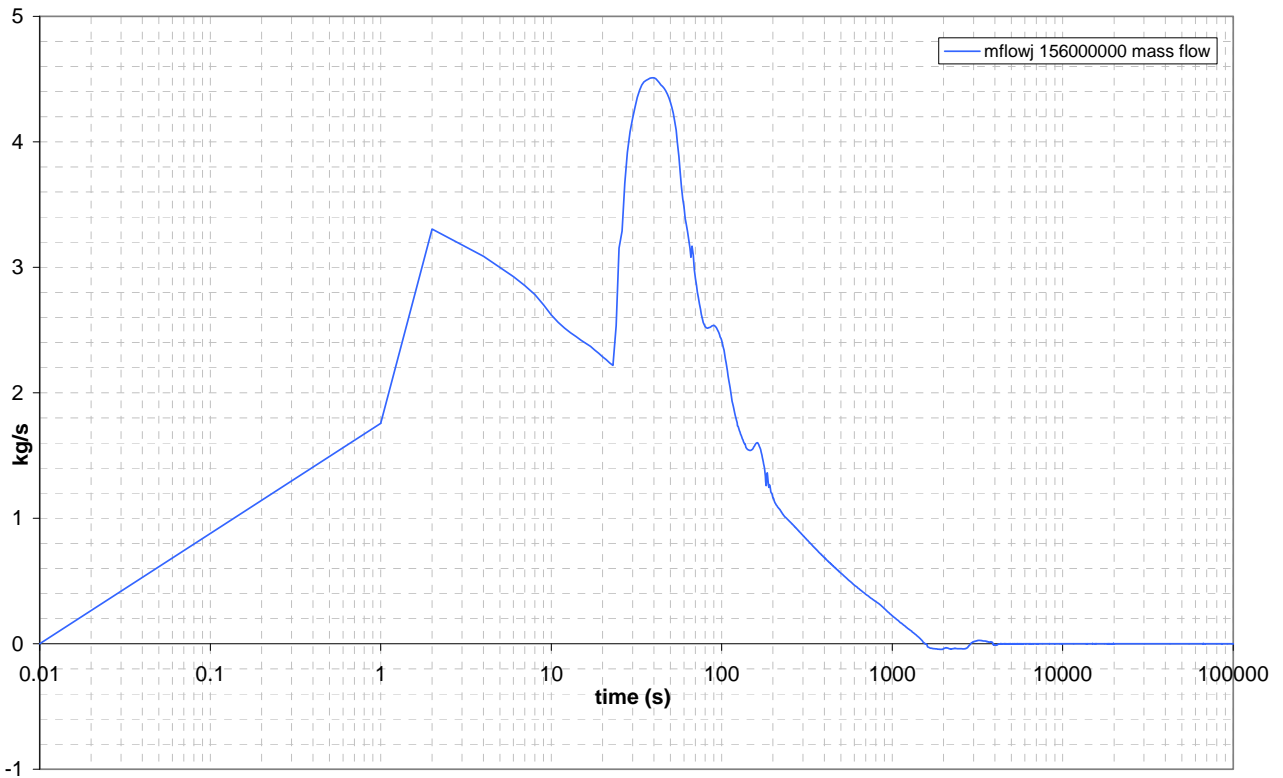

Figure 5.67: ADS ST SPLIT BREAK LINE mass flowrate

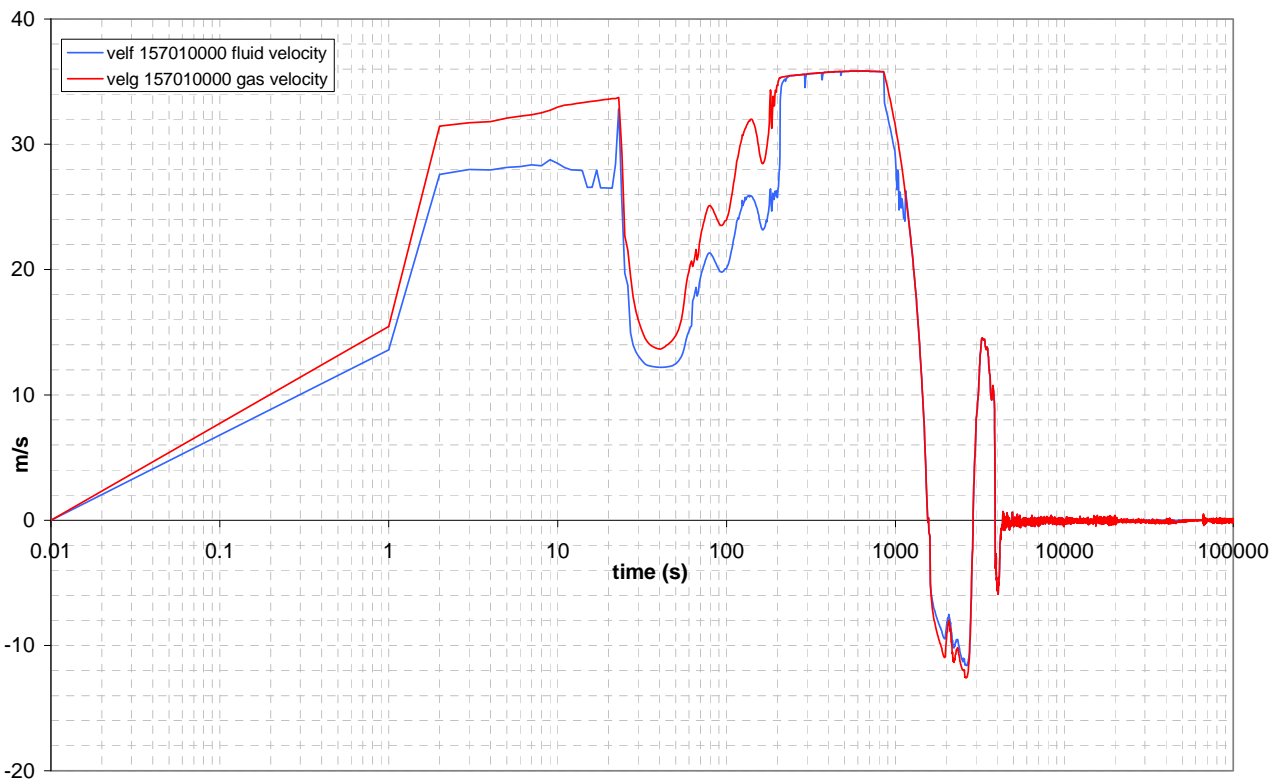

Figure 5.68: ADS ST SPLIT BREAK LINE liquid and gas velocities UPSTREAM

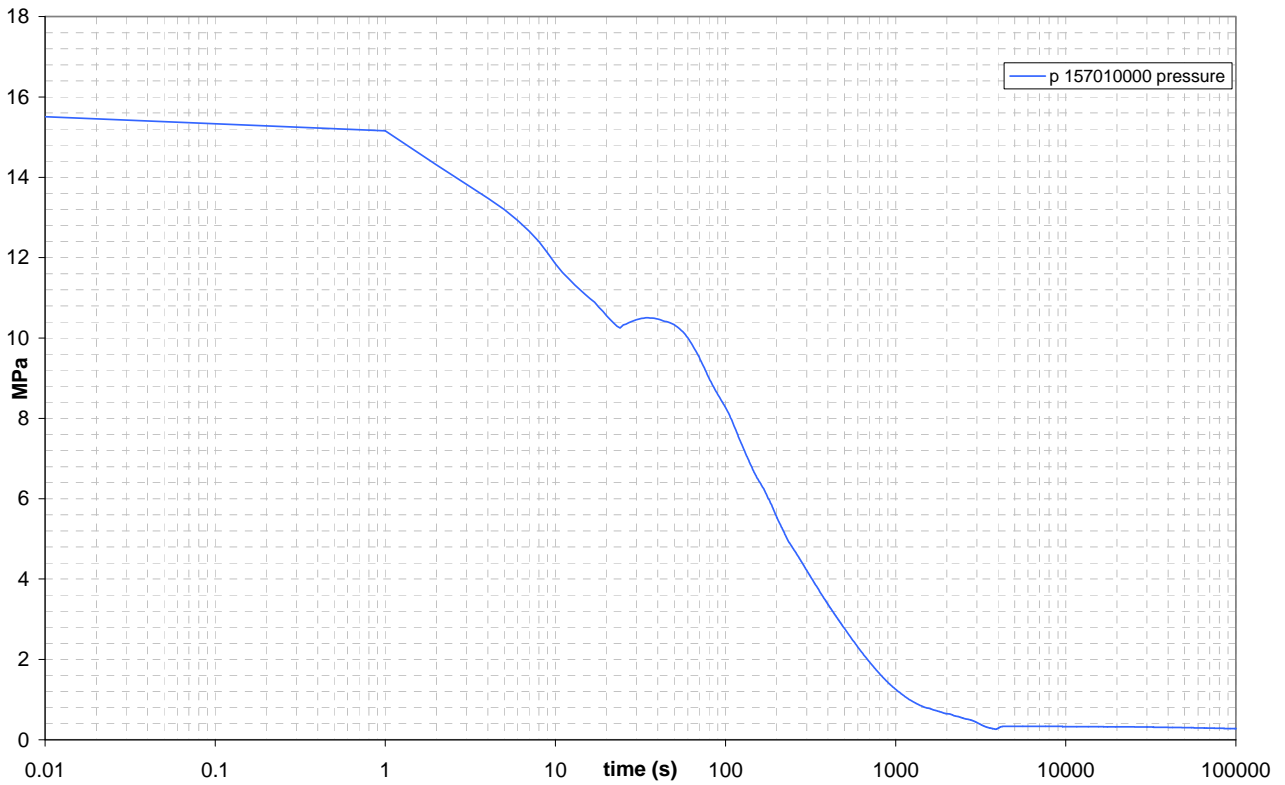

Figure 5.69: ADS ST SPLIT BREAK LINE pressure UPSTREAM

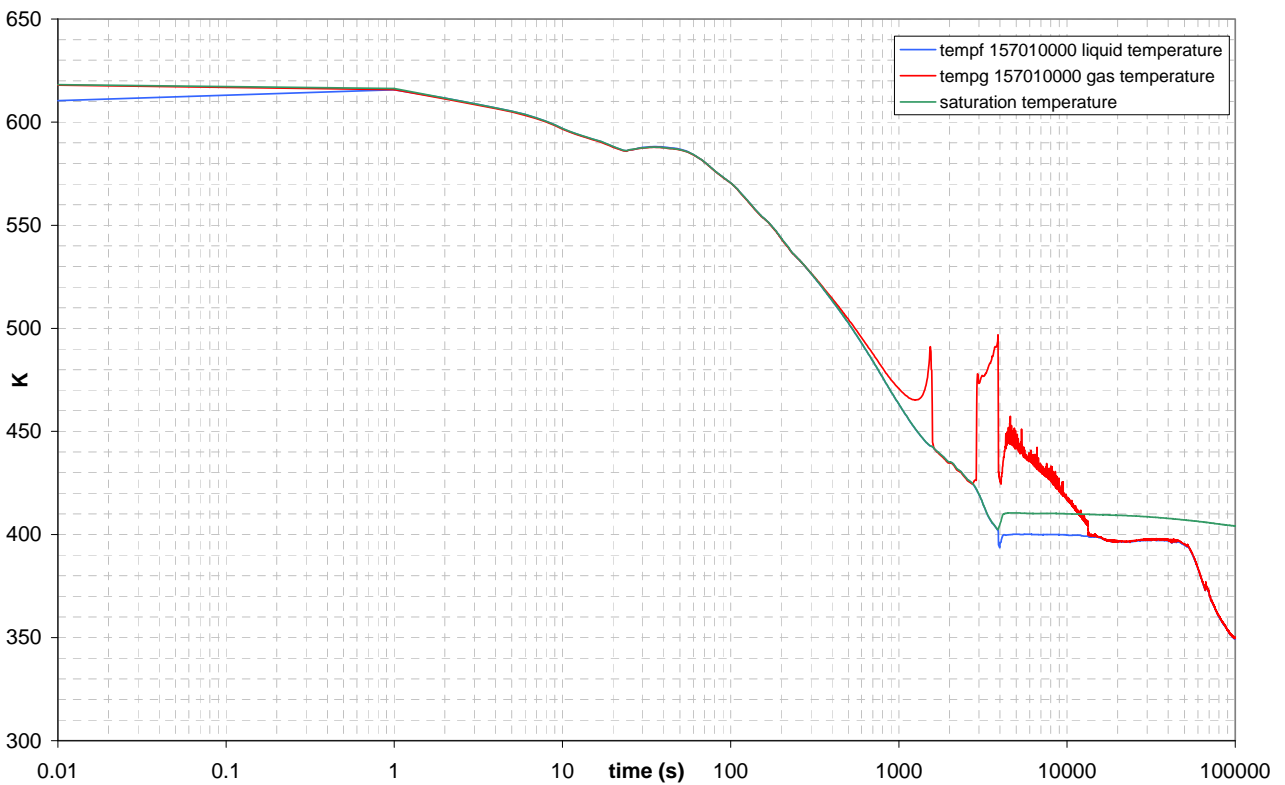

Figure 5.70: ADS ST SPLIT BREAK LINE liquid and gas temperatures UPSTREAM

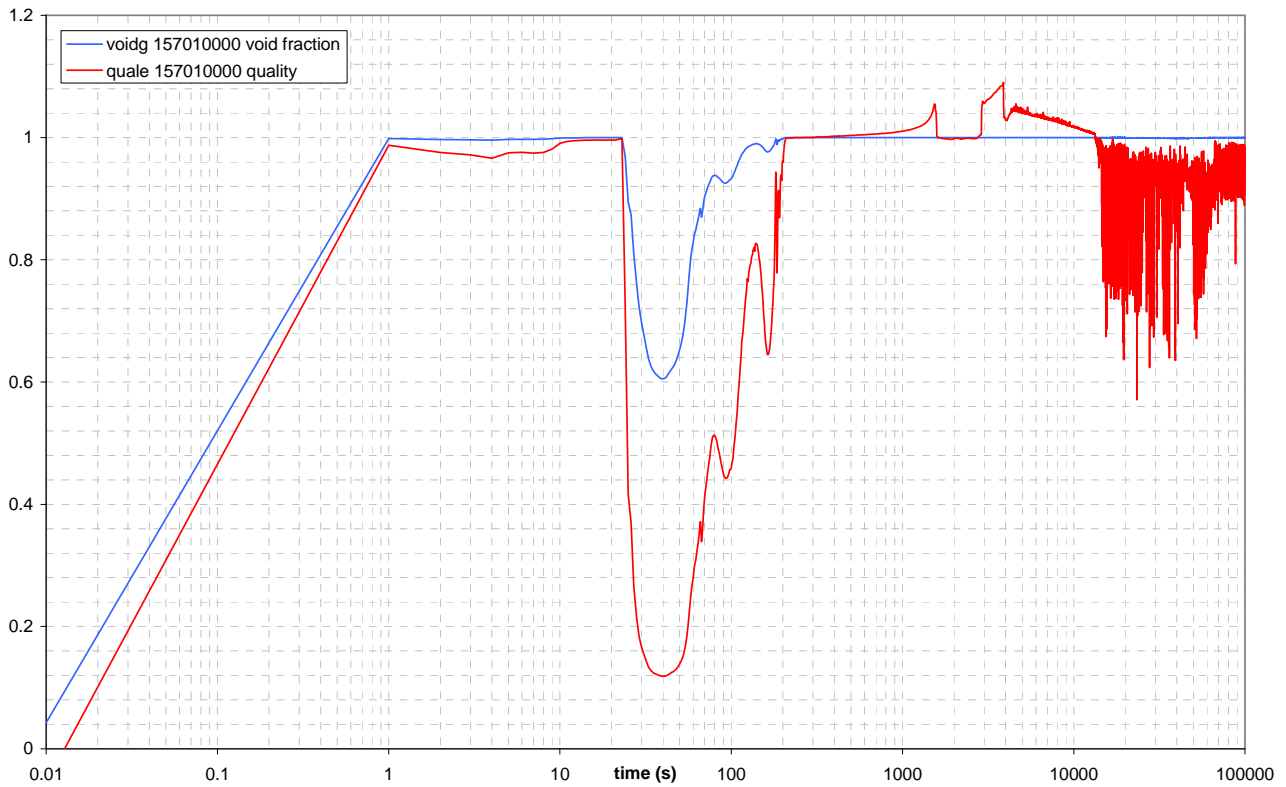

Figure 5.71: ADS ST SPLIT BREAK LINE void fraction and quality UPSTREAM

Table 5.28: Maximum and minimum values of the main variables in the ADS ST SPLIT break line upstream of the break

ADS SPLIT break line UPSTREAM		MIN	MAX
void fraction		0.0424	1.0000
volume equilibrium quality		-0.0560	1.0905
mass flowrate	kg/s	-0.0442	4.5107
liquid velocity	m/s	-11.6084	35.8412
gas velocity	m/s	-12.5918	35.8412
liquid temperature	K	349.4430	615.6810
gas temperature	K	349.5890	617.9750
pressure	MPa	0.2640	15.5067

The Table 5.28 shows the minimum and maximum values of void fraction, quality, mass flowrate, liquid and gas velocities, liquid and gas temperatures, pressure during the transient, upstream of the break.

DOWNSTREAM

The Figure 5.72, Figure 5.73, Figure 5.74 and Figure 5.75 represent the liquid and gas velocities, the pressure, the liquid and gas temperatures, the void fraction and the quality of the volume 133040000, downstream of the break in the ADS ST SPLIT line, Figure 4.16. Figure 5.76 shows the volumetric flowrate calculated using the area of the pipe, the void fraction, the gas and liquid velocities.

The mass flowrate is not shown because it is the same downstream and upstream the break.

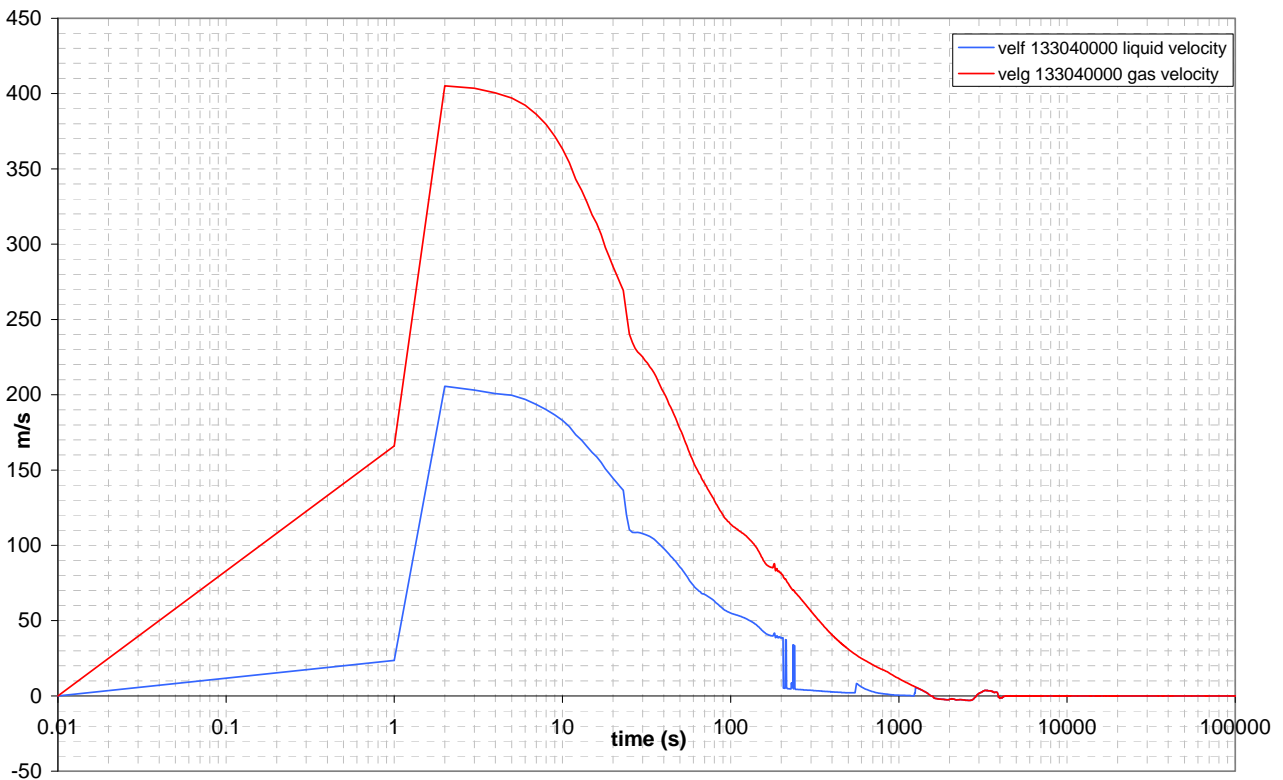

Figure 5.72: ADS ST SPLIT BREAK LINE liquid and gas velocities DOWNSTREAM

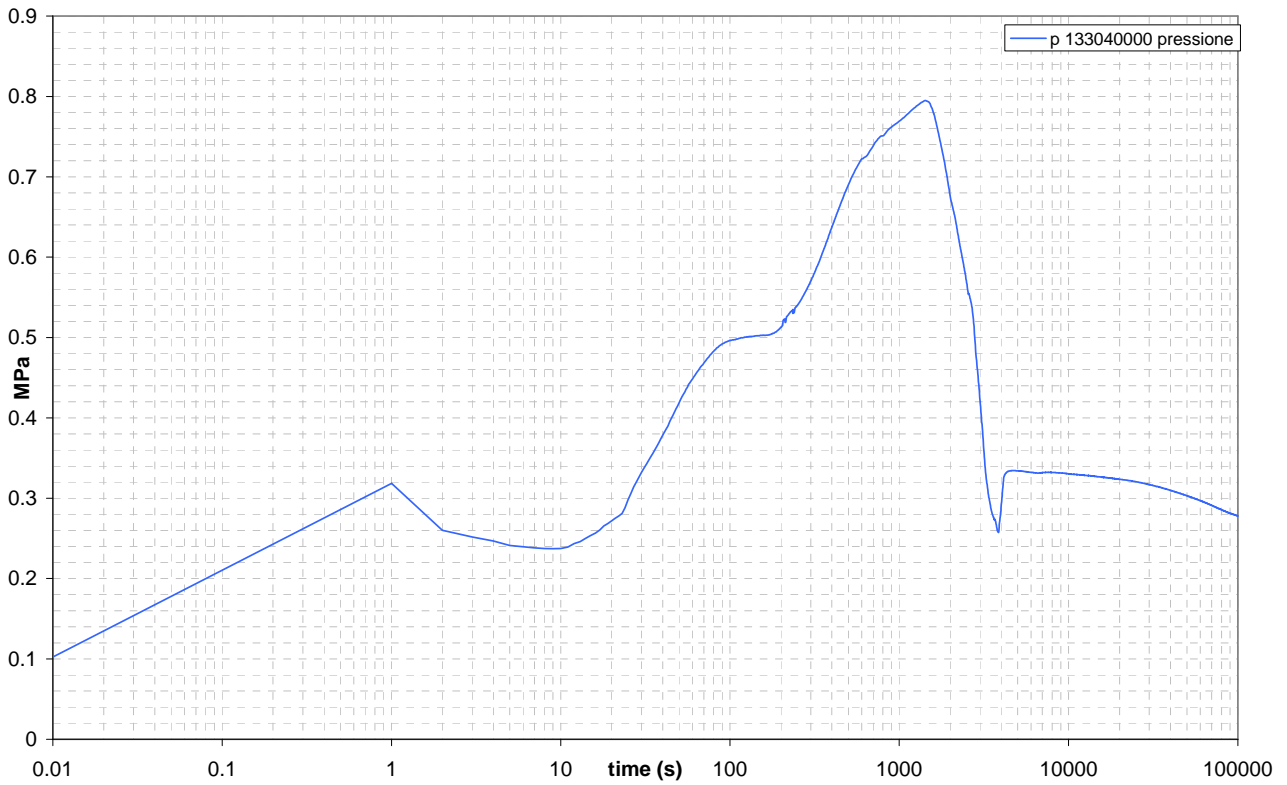

Figure 5.73: ADS ST SPLIT BREAK LINE pressure DOWNSTREAM

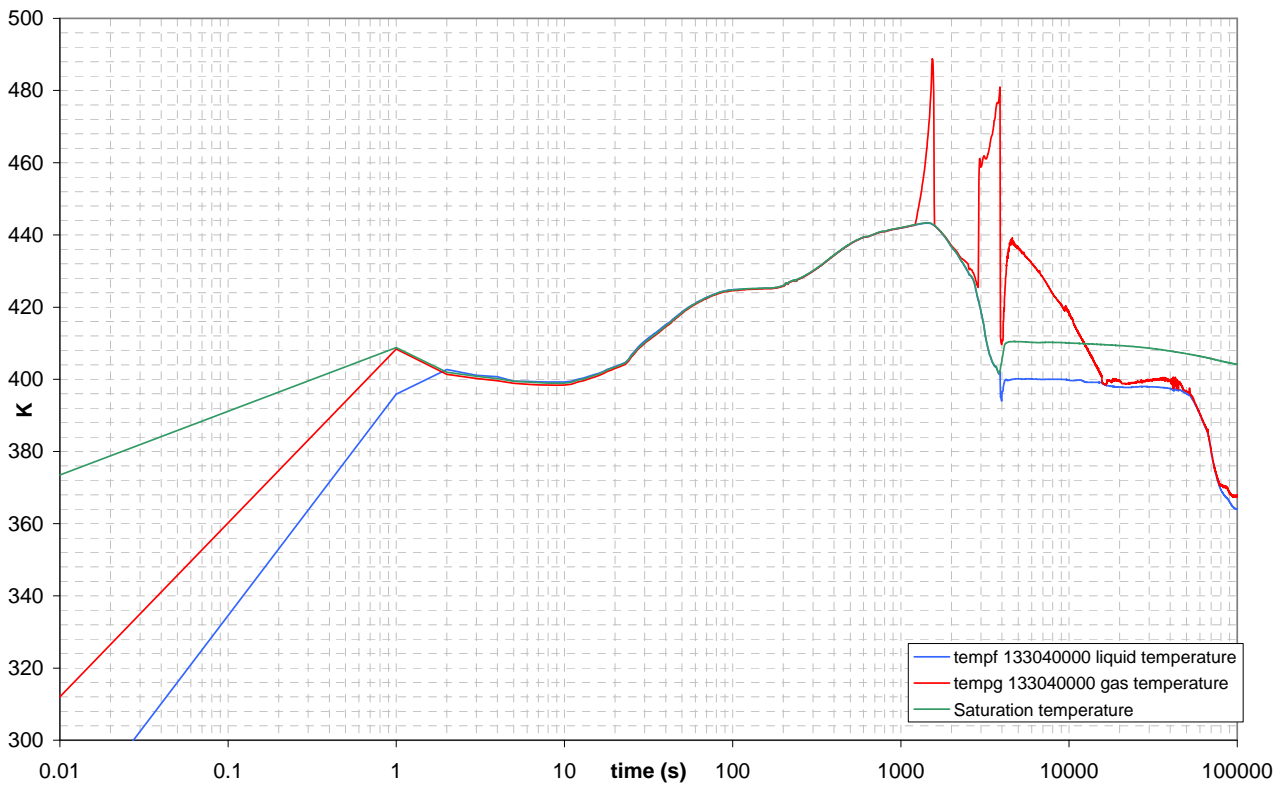

Figure 5.74: ADS ST SPLIT BREAK LINE liquid and gas temperatures DOWNSTREAM

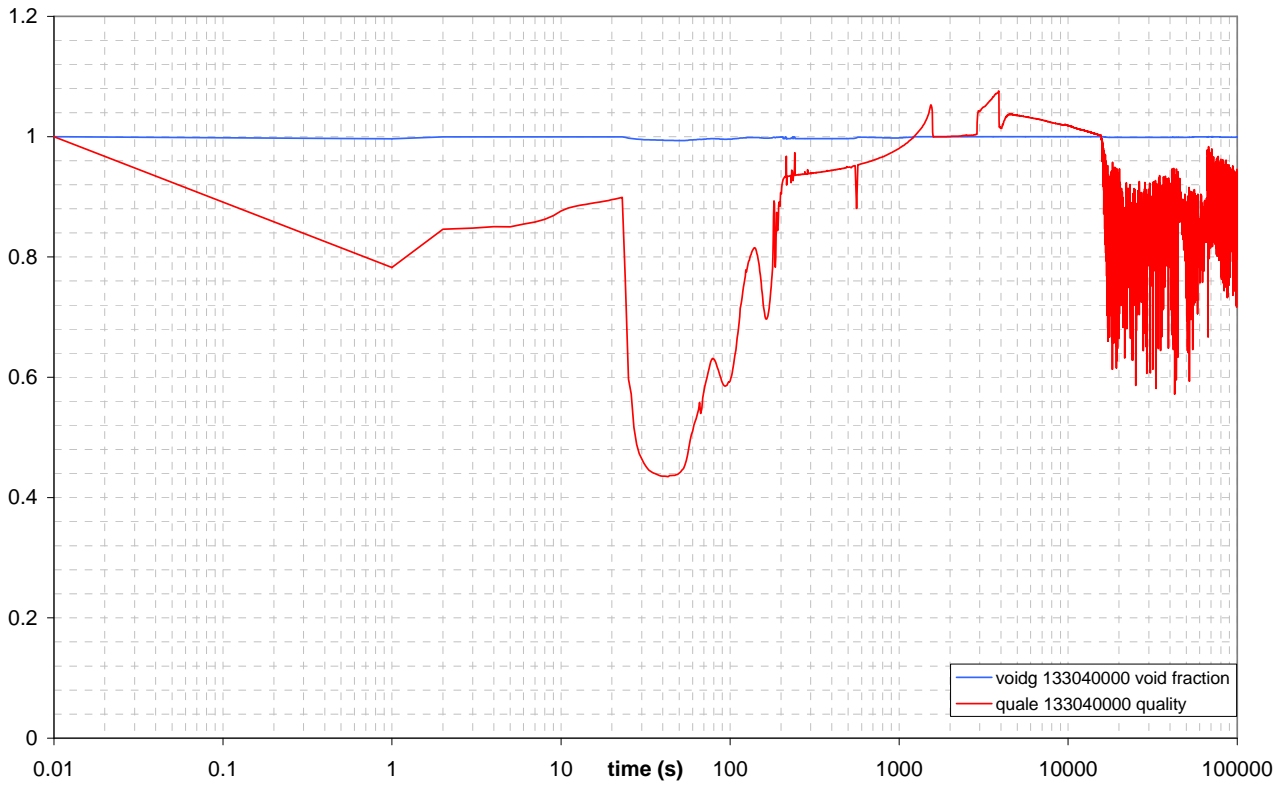

Figure 5.75: ADS ST SPLIT BREAK LINE void fraction and quality DOWNSTREAM

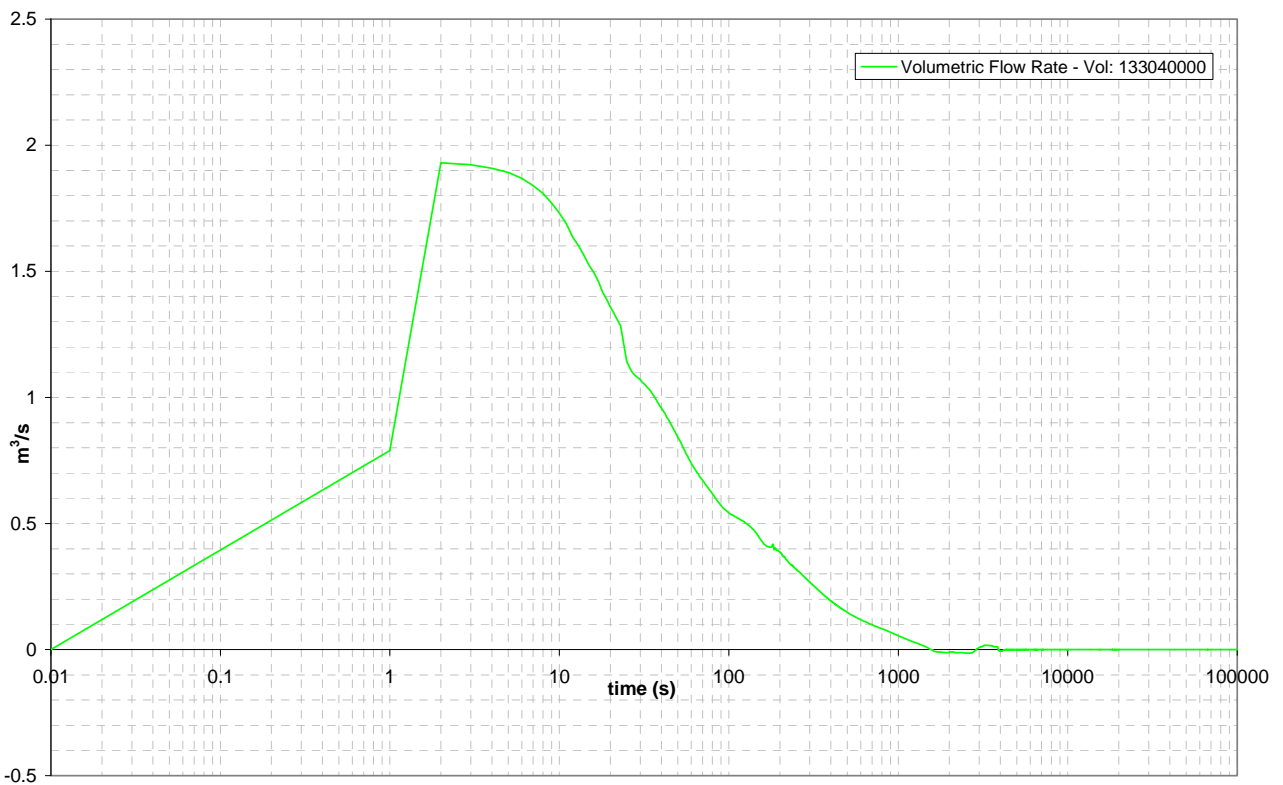

Figure 5.76: ADS ST SPLIT BREAK LINE volumetric flowrate DOWNSTREAM

The Table 5.29 shows the minimum and maximum values of void fraction, quality, mass flowrate, liquid and gas velocities, liquid and gas temperatures, pressure and volumetric flowrate during the transient downstream of the break.

Table 5.29: Maximum and minimum values of the main variables in the ADS SPLIT break line downstream of the break

ADS SPLIT break line DOWNSTREAM		MIN	MAX
void fraction		0.9935	1
volume equilibrium quality		0.4345	1.0757
mass flowrate	kg/s	-0.04422	4.5107
liquid velocity	m/s	-2.928	205.687
gas velocity	m/s	-2.928	405.115
liquid temperature	K	364.03	443.29
gas temperature	K	367.36	488.81
pressure	MPa	0.1024	0.7949
volumetric flowrate	m ³ /s	-0.014	1.930

The Table 5.30 describes the flow regimes indicated by the nodalization in the volume before the break and in some volumes after the break. The time step changes only when there is a modification in the flow regime. The volumes highlighted in red indicate the monitoring points.

FLOW REGIME

Table 5.30: Flow regimes function of monitoring volumes and time – ADS ST SPLIT LINE

Time	157010000	133010000	133040000	133070000	159010000
0	HST	CHF MPR	CHF MPR	CHF MPR	CHF MPR
1	HST	ANM	ANM	ANM	ANM
	ANM	ANM	ANM	ANM	ANM
22	ANM	ANM	ANM	ANM	ANM
23	CHF MPR	ANM	ANM	ANM	ANM
27	ANM	ANM	ANM	ANM	ANM
57	SLG	ANM	ANM	ANM	ANM
207	ANM	ANM	ANM	ANM	ANM
333	CHF MPR	ANM	ANM	ANM	ANM
550	CHF MPR	ANM	ANM	ANM	HST
1140	CHF MPR	ANM	HST	HST	HST
1520	CHF MPR	HST	HST	HST	HST
1550	CHF MPR	HST	HST	HST	CHF MPR
1560	HST	HST	HST	HST	CHF MPR
1570	CHF MPR	HST	HST	CHF MPR	CHF MPR
1580	HST	HST	CHF MPR	CHF MPR	CHF MPR
1590	HST	HST	CHF MPR	HST	HST
2130	HST	HST	HST	HST	HST
2140	HST	CHF MPR	HST	HST	HST
2740	HST	CHF MPR	CHF MPR	CHF MPR	CHF MPR
3890	CHF MPR	CHF MPR	CHF MPR	CHF MPR	CHF MPR
3960	CHF MPR	CHF MPR	CHF MPR	HST	HST
13290	CHF MPR	CHF MPR	CHF MPR	CHF MPR	CHF MPR
15420	HST	HST	CHF MPR	CHF MPR	CHF MPR
15430	HST	HST	HST	CHF MPR	CHF MPR
15660	HST	HST	CHF MPR	CHF MPR	CHF MPR
15840	HST	HST	HST	CHF MPR	CHF MPR
16270	HST	HST	HST	HST	CHF MPR
16710	HST	HST	HST	HST	HST/ CHF MPR
99990	HST	HST	HST	HST	HST

5.3.2.1 Synthesis of achievements for the ADS SPLIT break

As indicated by Figure 5.69 and Table 5.28, pressure upstream of the break is very high (15.5 MPa), at least at the beginning of the transient, whereas pressure downstream the break reaches at maximum 0.79 MPa, as shown in Figure 5.73. Therefore the installation of an eventual spool piece is suggested downstream of the break.

The mass flowrate in the ADS ST SPLIT break line is large, with the maximum value of 4.51 Kg/s, as shown in Figure 5.67. Despite the void fraction downstream of the break is always high, around 0.99, as indicated in Figure 5.75, water is clearly sucked towards the break when the PRZ level increases for the RV top part depressurization, Figure 5.71 and [4].

Therefore, the installation of a spool piece is planned for the ADS ST SPLIT line. The device will be located downstream of the break in the zone corresponding to volume 133040000 of the nodalization, Figure 4.16. As indicated in Table 5.30, it will experiment three different flow regimes: annular mist, mist pre-CHF and horizontal stratified.

For the EBT SPLIT break line, a Venturi meter will be installed upstream of the break.

5.3.3 ADS lines

As detailed in [4], both the ADS Stage-I lines are opened on contemporary signal of high containment pressure and low PRZ pressure. The ADS Stage-I lines opening helps to reduce pressure in the RV and anticipates the safety systems intervention to make-up water in the primary side. The ADS Stage-II lines open later in the transient, on a low LGMS mass signal, to improve the steam circulation between primary and containment systems in the upper part of the plant.

Being the ADS ST Stage-I valve downstream of the DEG line, it has no effect on the primary system depressurization, while the ADS DT Stage-I line operates correctly: when the ADS DT Stage-I valve opens, steam flows rapidly through the pipe sucking and entraining water from the PRZ. In this condition, a liquid fraction can flow through the pipe even if they are connected to the RV top, where steam is currently present.

The Table 5.31 describes the maximum and minimum values of mass flowrate and void fraction in the ADS single train and double train (stage I and II) during the ADS break test. The ADS St Stage-I data are reported for completeness, even if such lines does not contribute to the RV depressurization, as explained above. As the analysis of the DVI break case has stated the need of a spool piece on both the ST and DT Stage-I pipes, as for the EBT case, also data from the ADS break represent a further information on the measurable quantity ranges.

Table 5.31: Maximum and minimum values of the void fraction and mass flow in the ADS ST and DT (stage I and II) upstream and downstream of the valve (ADS test)

ADS break test		Volume	MIN	MAX
ADS ST stage I	Void Fraction	152030000 Upstr.	0**	1
ADS ST stage II	Void Fraction	135020000	0**	1
ADS DT stage I	Void Fraction	142080000	0.3793	1
ADS DT stage II	Void Fraction	132020000	0.0845	1
ADS ST stage I	Void Fraction	134010000 Downst.	0.8859	1
ADS ST stage II	Void Fraction	155010000	0.9512	1
ADS DT stage I	Void Fraction	131010000	0.9522	1
ADS DT stage II	Void Fraction	145010000	0.9978	1
ADS ST stage I	Mass Flow kg/s	153000000	-0.2696	0.0102
ADS ST stage II	Mass Flow kg/s	154000000	0	0
ADS DT stage I	Mass Flow kg/s	143000000	-0.0111	3.1324
ADS DT stage II	Mass Flow kg/s	144000000	0	0

** This value is due to a water plug formed upstream of the break caused by steam condensation in the steady state. The plug is outright ejected when the valve opens, then the void fraction reaches the minimum value of 0.45 for both the lines.

The Figure 5.77 and Figure 5.78 represent the void fraction trend in the ADS DT Stage-I line and Figure 5.79 represents the mass flow. The involved volumes are 142080000 (upstream) and 131010000 (downstream). Figure 5.80 shows the volumetric flowrate calculated using the area of the pipe, the void fraction, the gas and liquid velocities.

5.3.3.1 Synthesis of achievements for the ADS lines

ADS Stage-I

Table 5.31 shows that the mass flow is meaningful only in the ADS DT Stage-I and that the void fraction is very high for the whole transient. Anyway, following the DVI break case analysis, a spool piece is foreseen on each line. The devices will be located downstream of the valves in zones corresponding to volumes 134010000 and 131010000 for the ST and DT, respectively. The ADS ST spool piece will be used only to measure the eventual reverse flow exiting the ADS DT Stage-I and re-entering the ST Stage-I through the common vertical collector to the QT [4]. Table 5.32 shows the minimum and maximum values (mass and volumetric flowrate, quality, void fraction, temperature, pressure, liquid and gas velocities) in this volume that are necessary to set the spool piece.

A Venturi meter will be installed upstream of the ADS ST and DT Stage-I valves.

ADS Stage-II

Table 5.31 shows that the mass flow is very little in both the ADS ST and DT Stage-II and also the void fraction excursions are limited around 1. For this reason no spool piece will be installed on such pipes.

A Venturi meter will be installed upstream of the ADS ST and DT Stage-II valves.

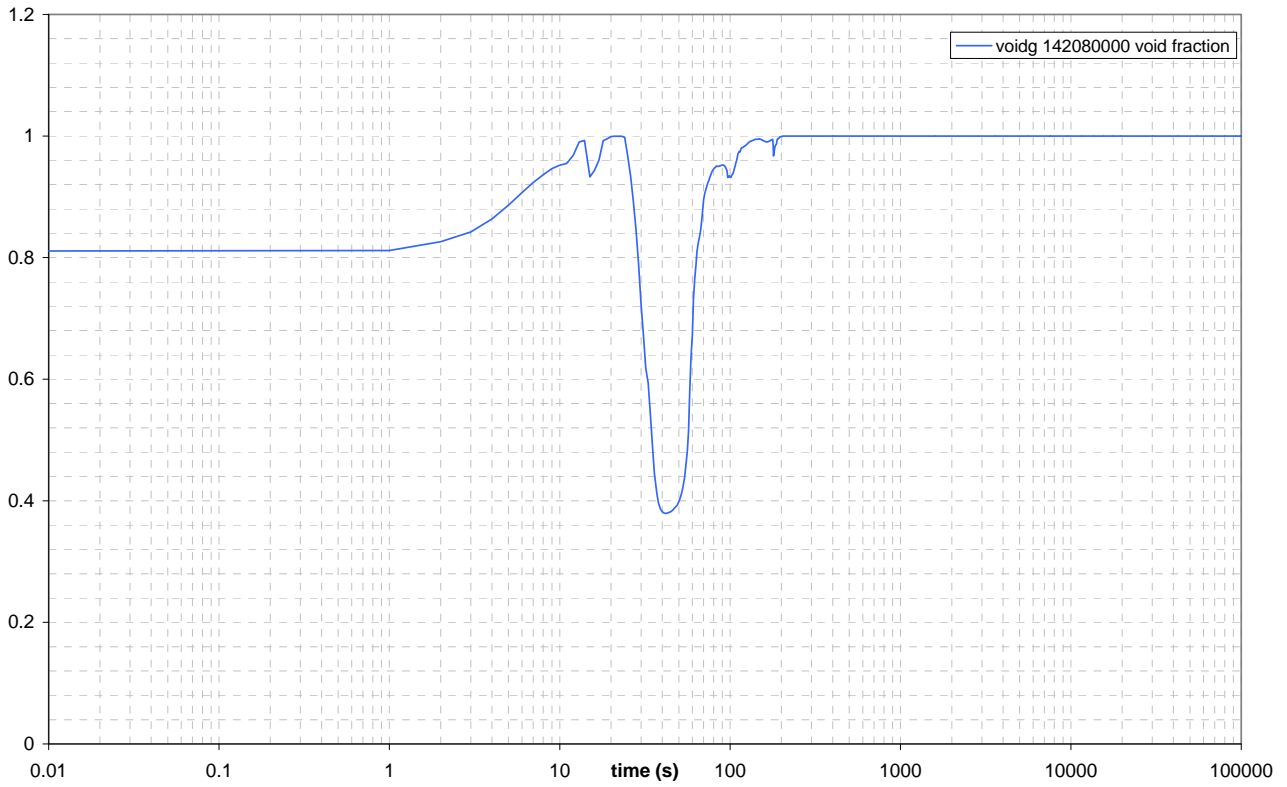

Figure 5.77: ADS TEST, ADS DT (stage I) LINE void fraction UPSTREAM

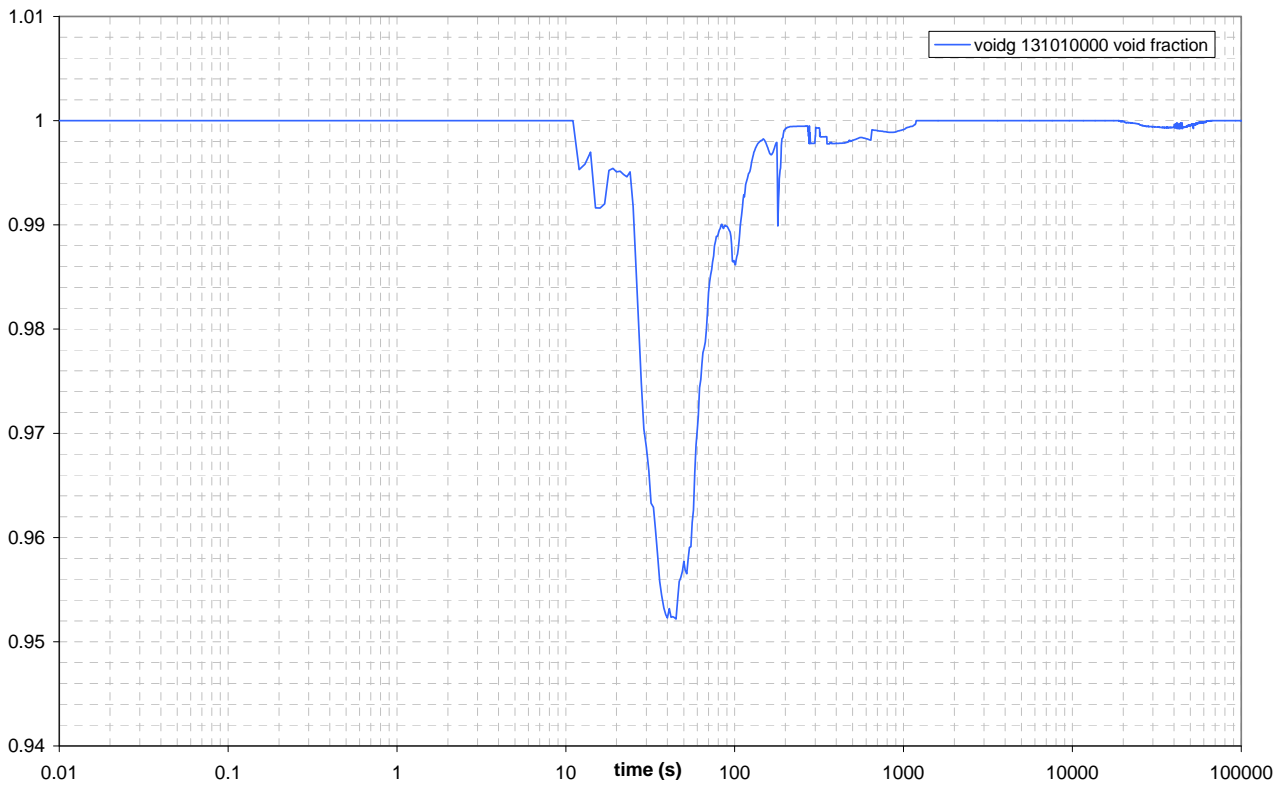

Figure 5.78: ADS TEST, ADS DT (stage I) LINE void fraction DOWNSTREAM

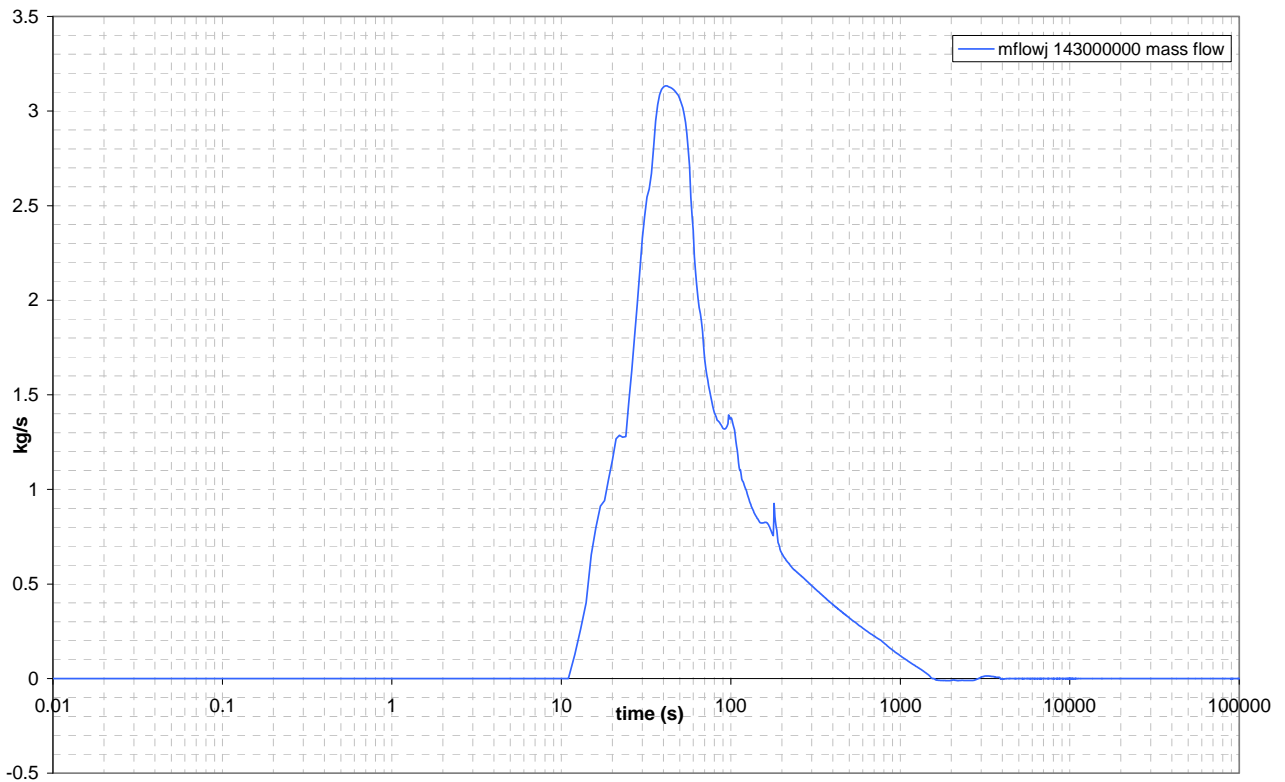

Figure 5.79: ADS TEST, ADS DT (stage I) LINE mass flow

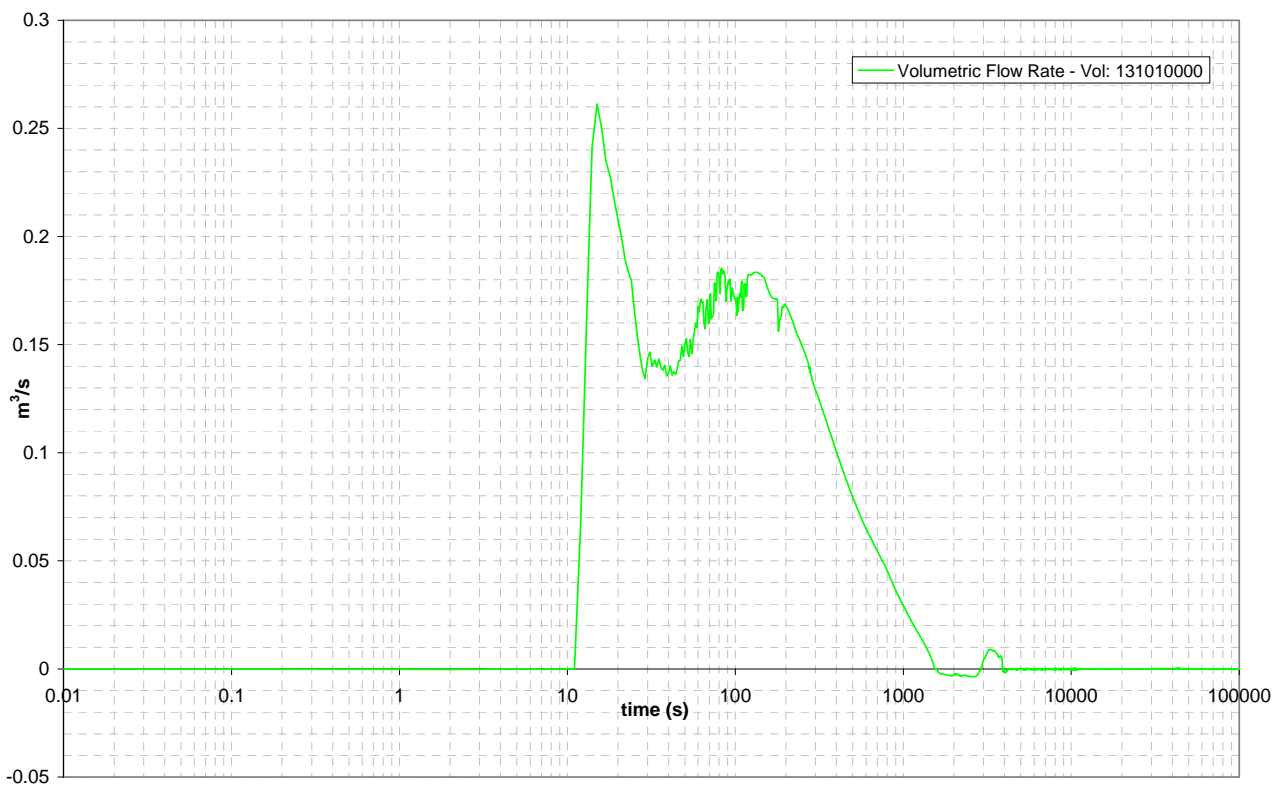

Figure 5.80: ADS TEST, ADS DT (stage I) LINE volumetric flowrate DOWNSTREAM

Table 5.32: Maximum and minimum values of the main variables in the
ADS ST (Stage-I) downstream of the valve (EBT break test)

ADS break test – ADS DT line DOWNSTREAM		MIN	MAX
void fraction		0.9522	1
volume equilibrium quality		0.3281	1.0695
mass flowrate	kg/s	-0.0111	3.1324
liquid velocity	m/s	-1.3163	29.1281
gas velocity	m/s	-1.3163	96.2626
liquid temperature	K	273.16	489.222
gas temperature	K	311.396	477.54
pressure	MPa	0.1024	1.3557
volumetric flowrate	m ³ /s	-0.004	0.261

5.4 SL BREAK TEST

The 16 inch equivalent SL-B DEG break is the largest secondary side break that may occur, inside the containment, in the IRIS plant [1].

It is a steam side break at the SG-B outlet and it is simulated in SPES3 by opening the valve system on the break lines departing from the SL-B, located between the EHRS-B hot leg connection and the SG-B outlet, Figure 4.11.

5.4.1 SL DEG break line

The **Errore. L'autoriferimento non è valido per un segnalibro.** describes the nodalization of the SL-B DEG BREAK line: one volume upstream of the valve, the junction (valve) that represents the break, five volumes downstream of the valve and the nozzle before the tank (end of line). The main variables and the flow regimes have been taken in the volumes indicated by “*”.

Table 5.33: Description of the volumes for the SL-B DEG break

UPSTREAM	MOTOR VALVE	DOWNSTRAM	END OF LINE
570010000 (*)	571000000	572010000 572020000 572030000 (*) 572040000 572050000	573010000

UPSTREAM

The Figure 5.81, Figure 5.82, Figure 5.83, Figure 5.84 and Figure 5.85 represent the mass flowrate, the liquid and gas velocities, the pressure, the liquid and gas saturation temperatures, the void fraction and the quality of the volume 570010000, upstream of the break in the SL-B DEG line,

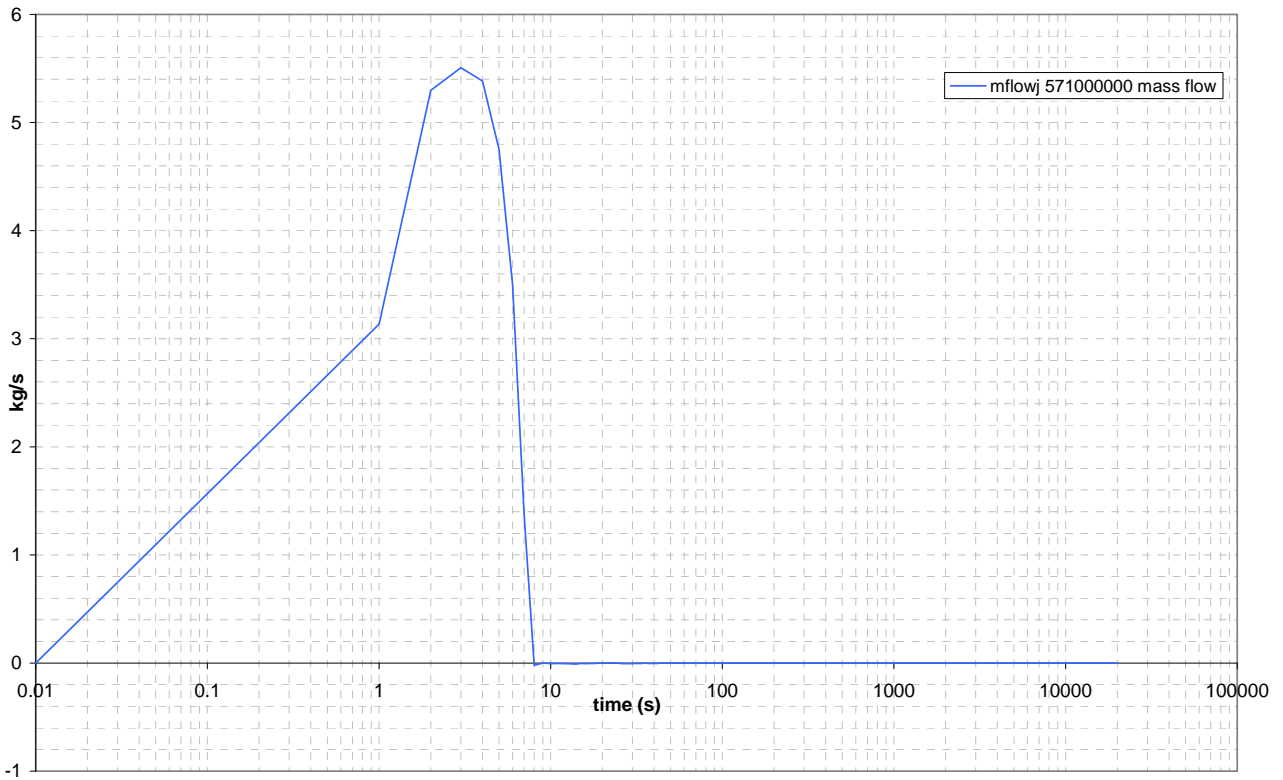

Figure 5.81: SL-B DEG BREAK LINE mass flowrate UPSTREAM

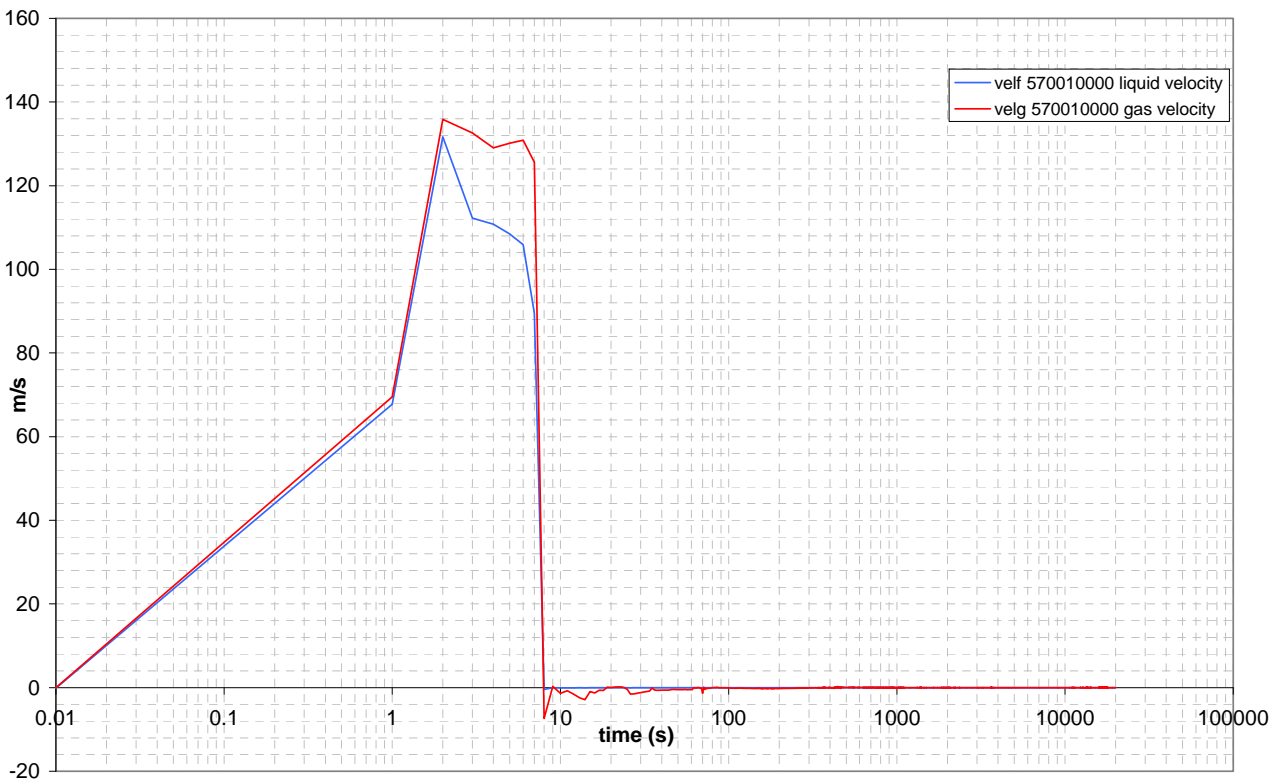

Figure 5.82: SL-B DEG BREAK LINE liquid and gas velocities UPSTREAM

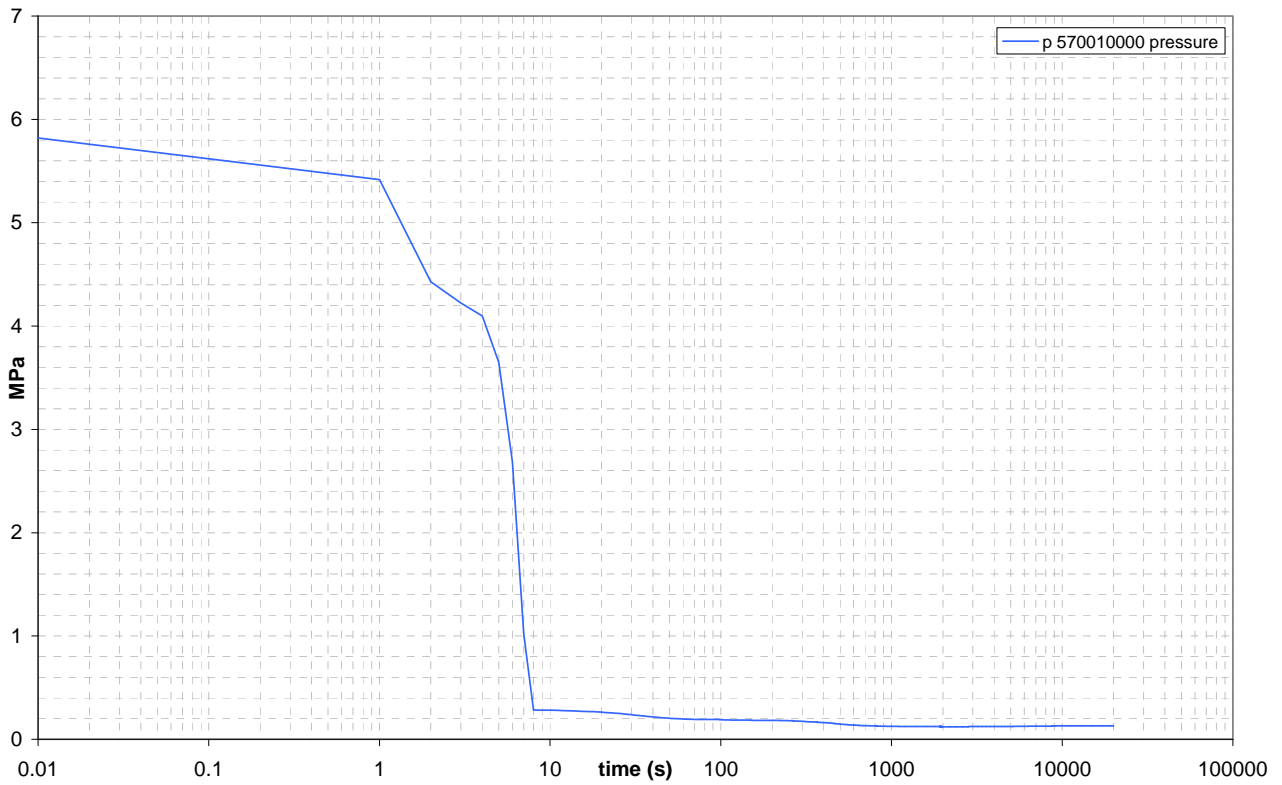

Figure 5.83: SL-B DEG BREAK LINE pressure UPSTREAM

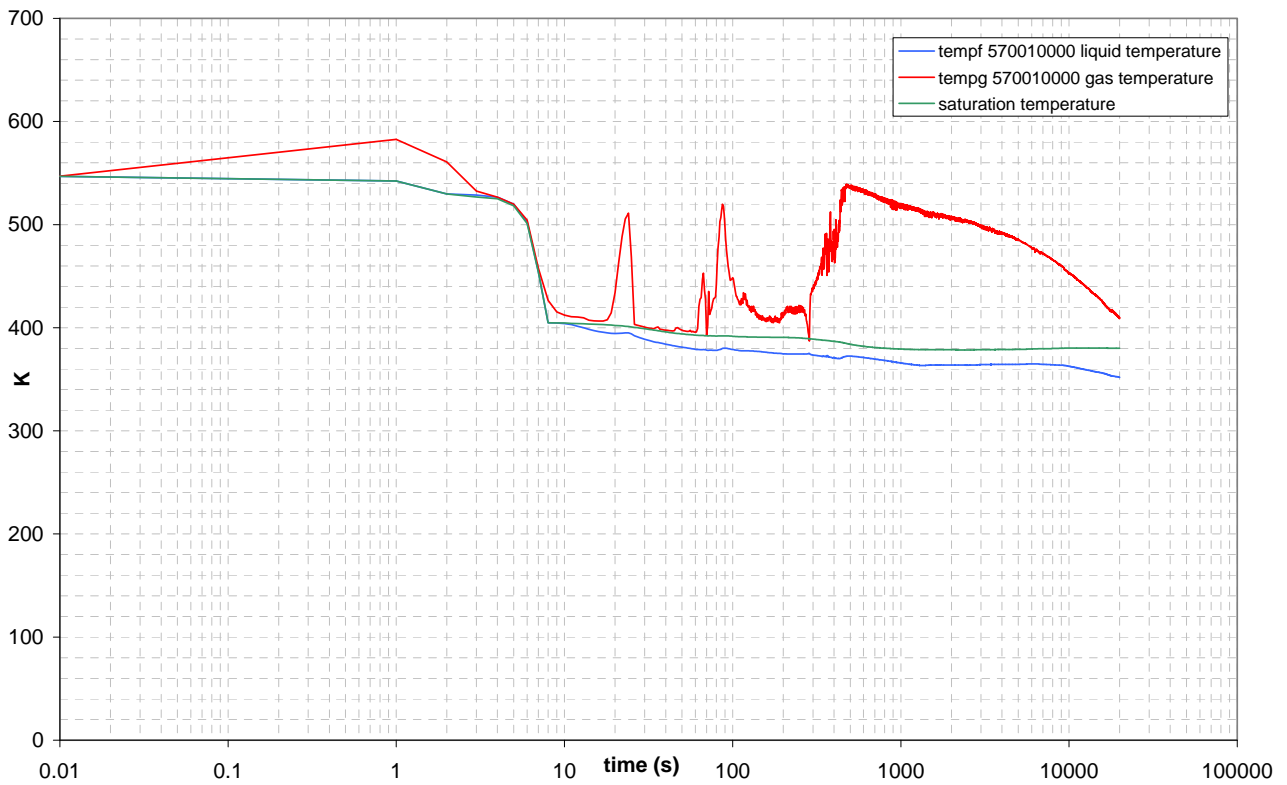

Figure 5.84: SL-B DEG BREAK LINE liquid and gas temperatures UPSTREAM

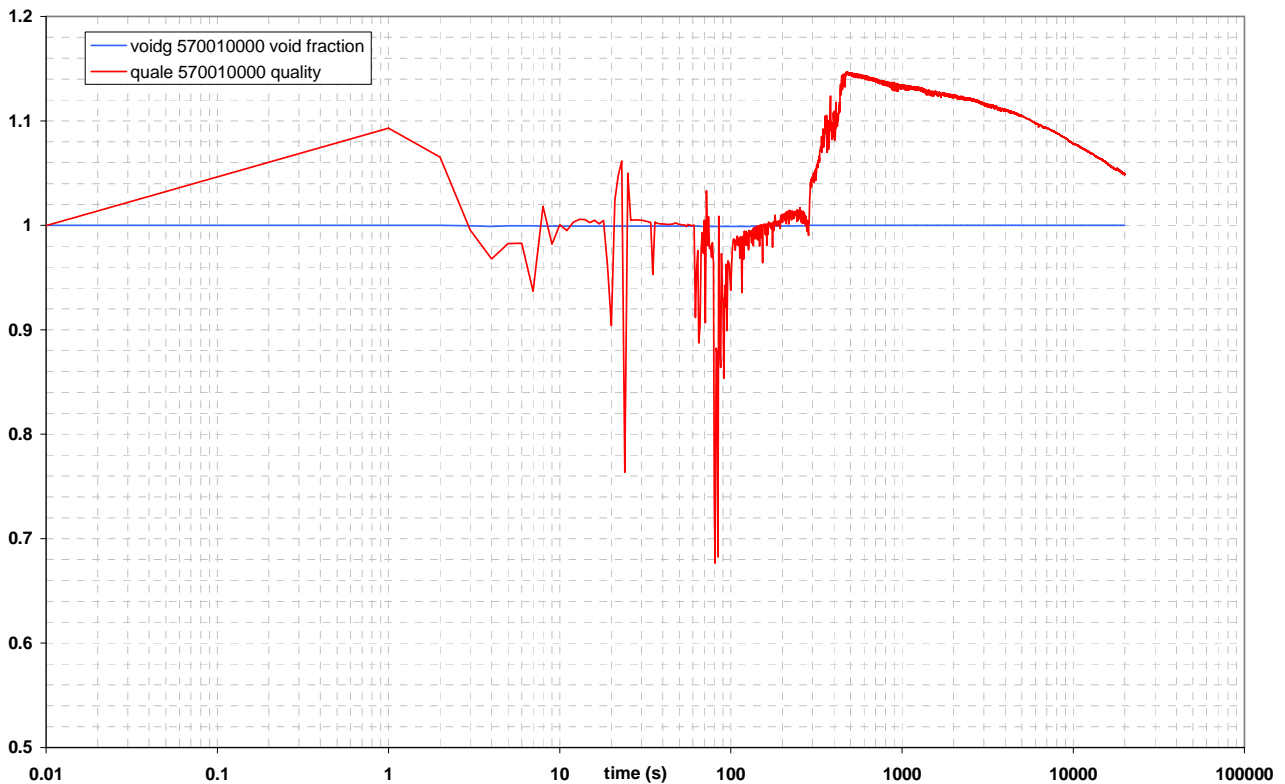

Figure 5.85: SL-B DEG BREAK LINE void fraction and quality UPSTREAM

Table 5.34: Maximum and minimum values of the main variables in the SL-B DEG break line upstream of the break

SL DEG break line UPSTREAM		MIN	MAX
void fraction		0.9990	1
volume equilibrium quality		0.6767	1.1471
mass flowrate	kg/s	-0.0212	5.5071
liquid velocity	m/s	-0.4145	131.6760
gas velocity	m/s	-7.3419	135.8310
liquid temperature	K	363.3310	546.7500
gas temperature	K	387.1220	582.7480
pressure	MPa	0.1224	5.8197

The Table 5.34 shows the minimum and maximum values of void fraction, quality, mass flowrate, liquid and gas velocities, liquid and gas temperatures, pressure during the transient, upstream of the break.

DOWNSTREAM

The Figure 5.86, Figure 5.87, Figure 5.88 and Figure 5.89 represent the liquid and gas velocities, the pressure, the liquid and gas temperatures, the void fraction and the quality of the volume 572030000, downstream of the break in the SL-B DEG line. Figure 5.90 shows the volumetric flowrate calculated using the area of the pipe, the void fraction, the gas and liquid velocities.

The mass flowrate is not shown because it is the same downstream and upstream the break.

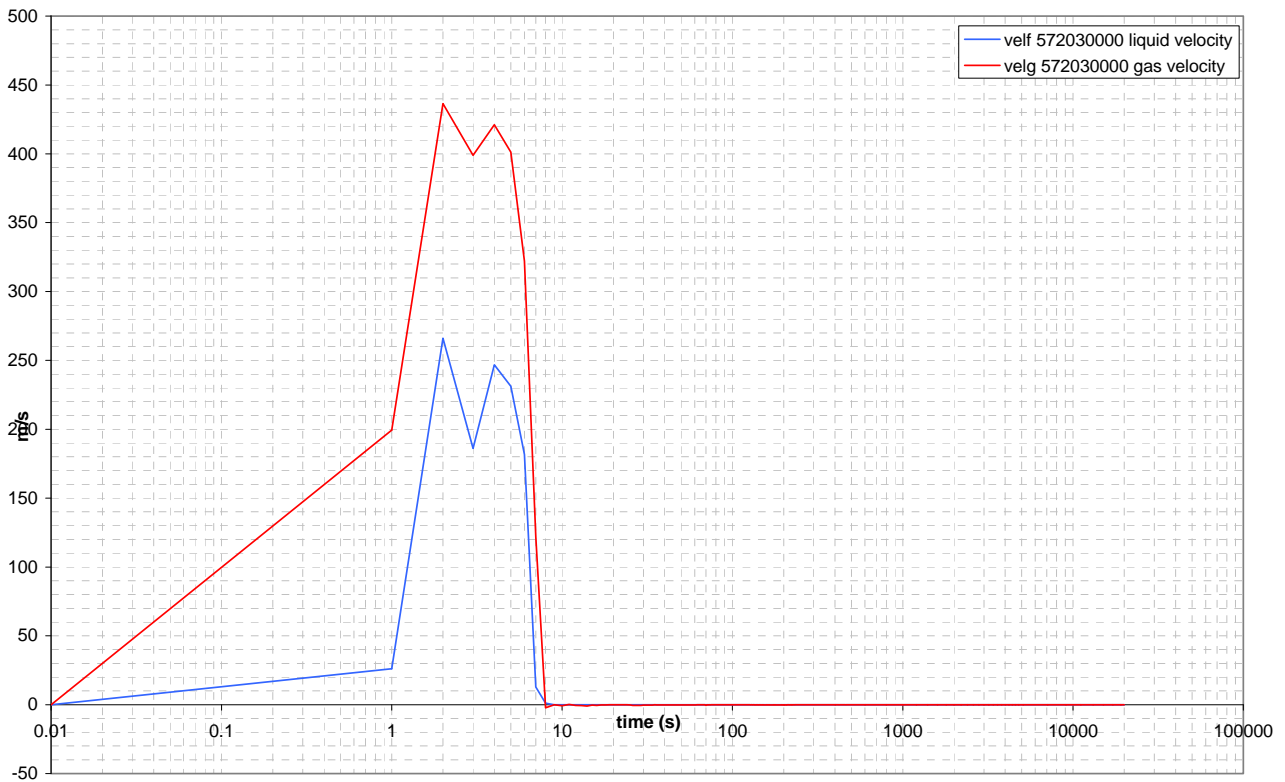

Figure 5.86: SL-B DEG BREAK LINE liquid and gas velocities DOWNSTREAM

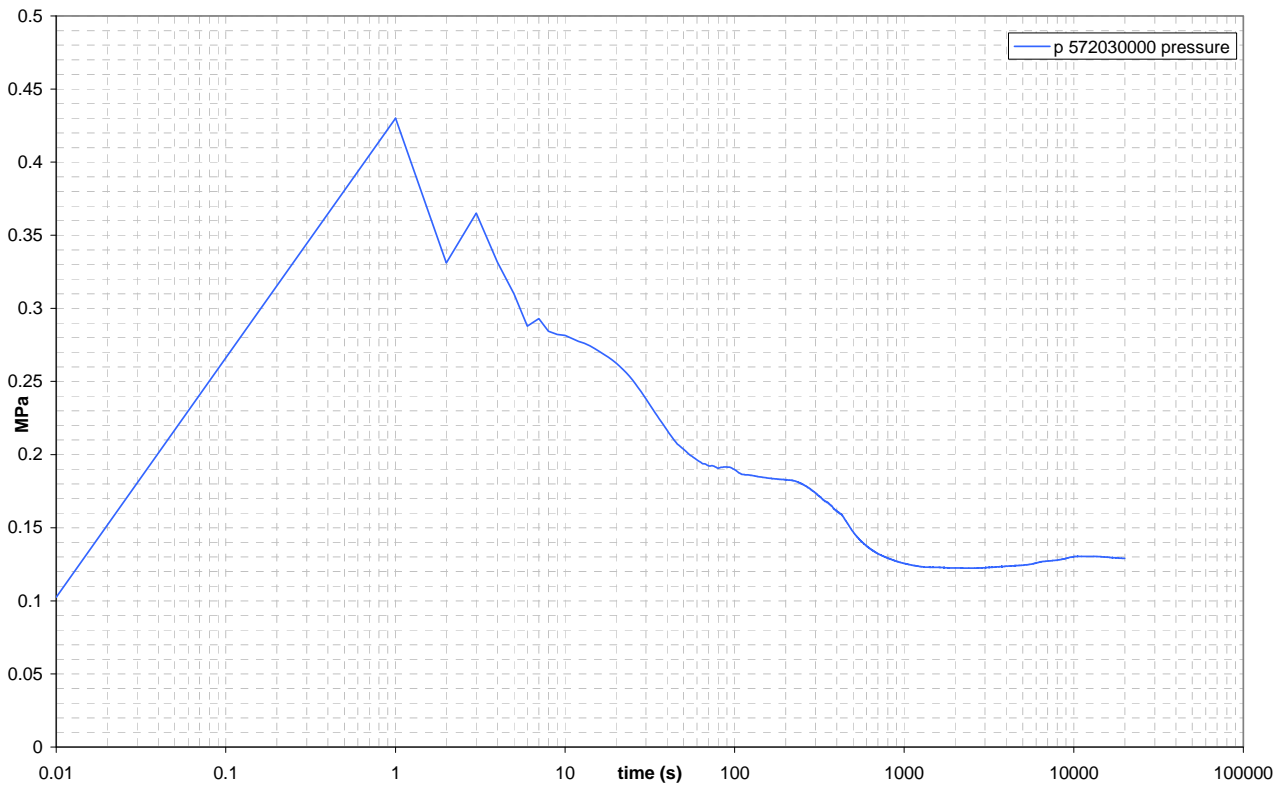

Figure 5.87: SL-B DEG BREAK LINE pressure DOWNSTREAM

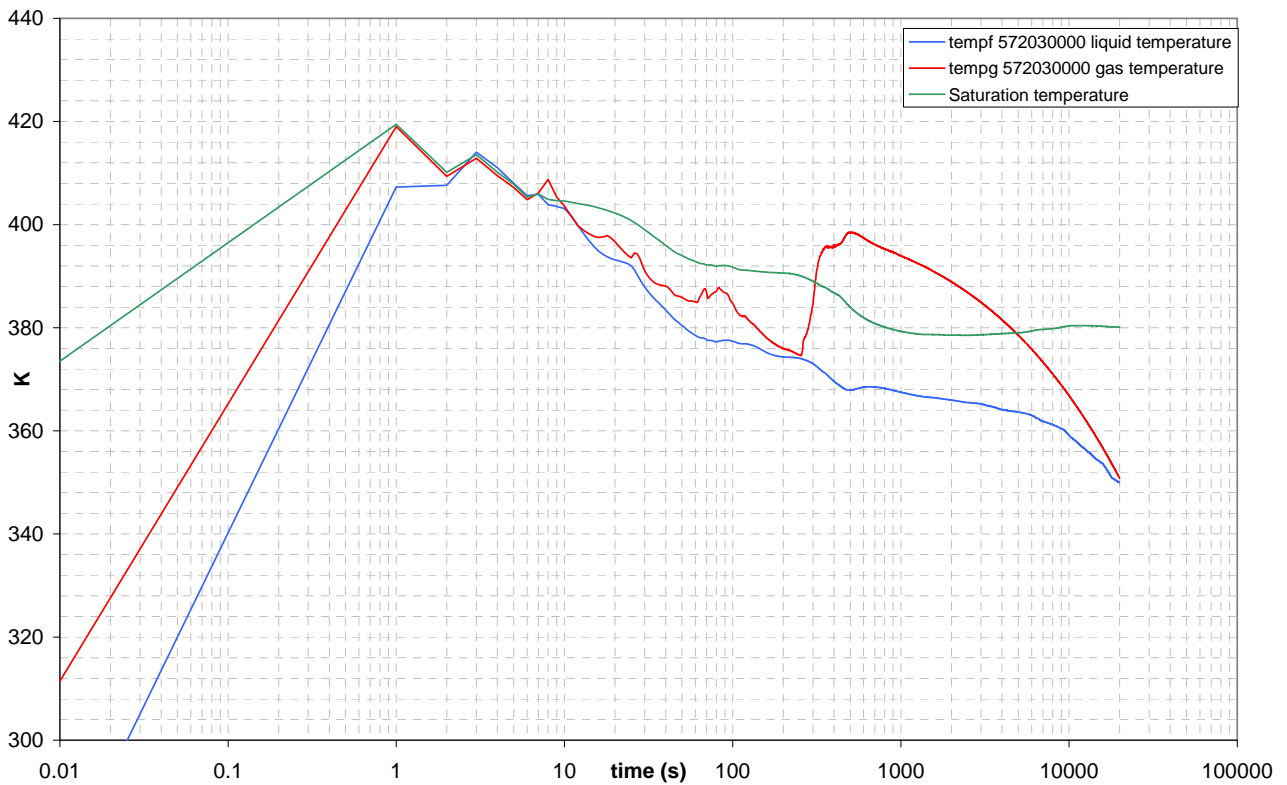

Figure 5.88: SL-B DEG BREAK LINE liquid and gas temperatures DOWNSTREAM

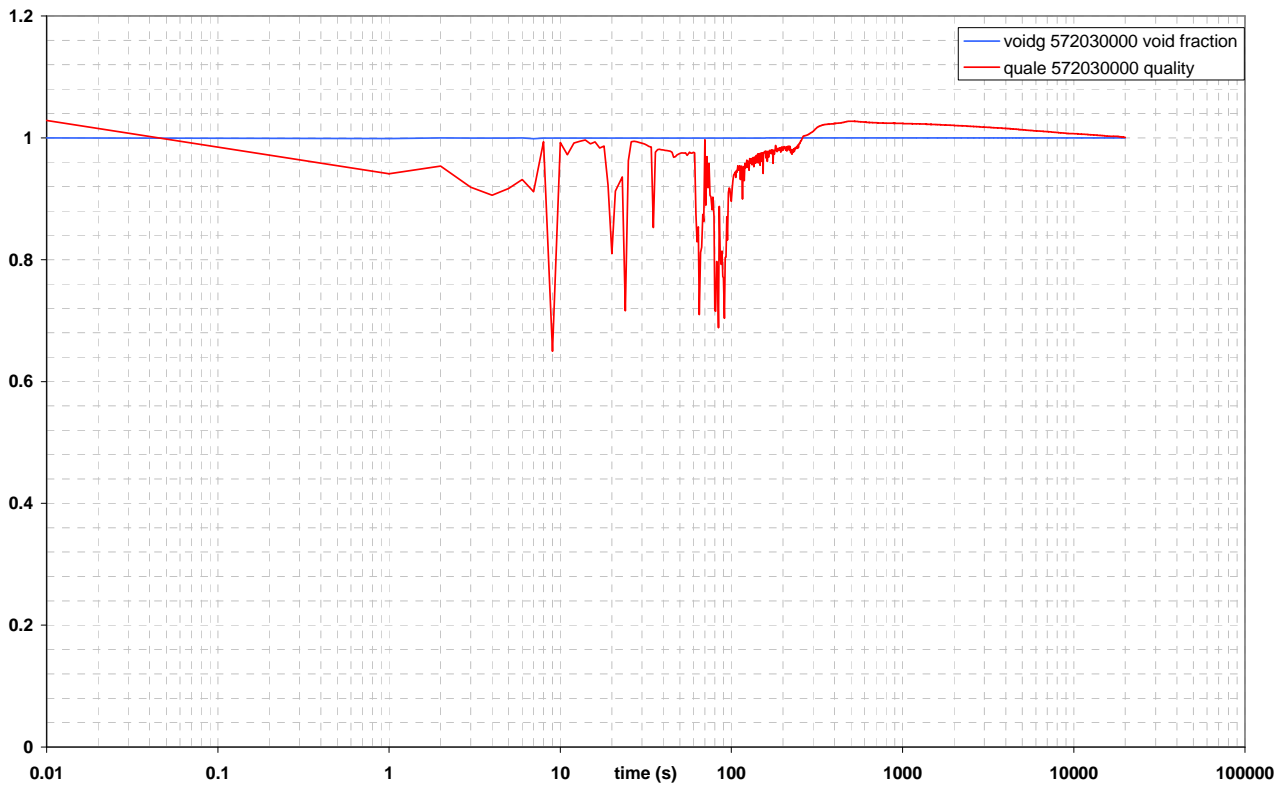

Figure 5.89: SL-B DEG BREAK LINE void fraction and quality DOWNSTREAM

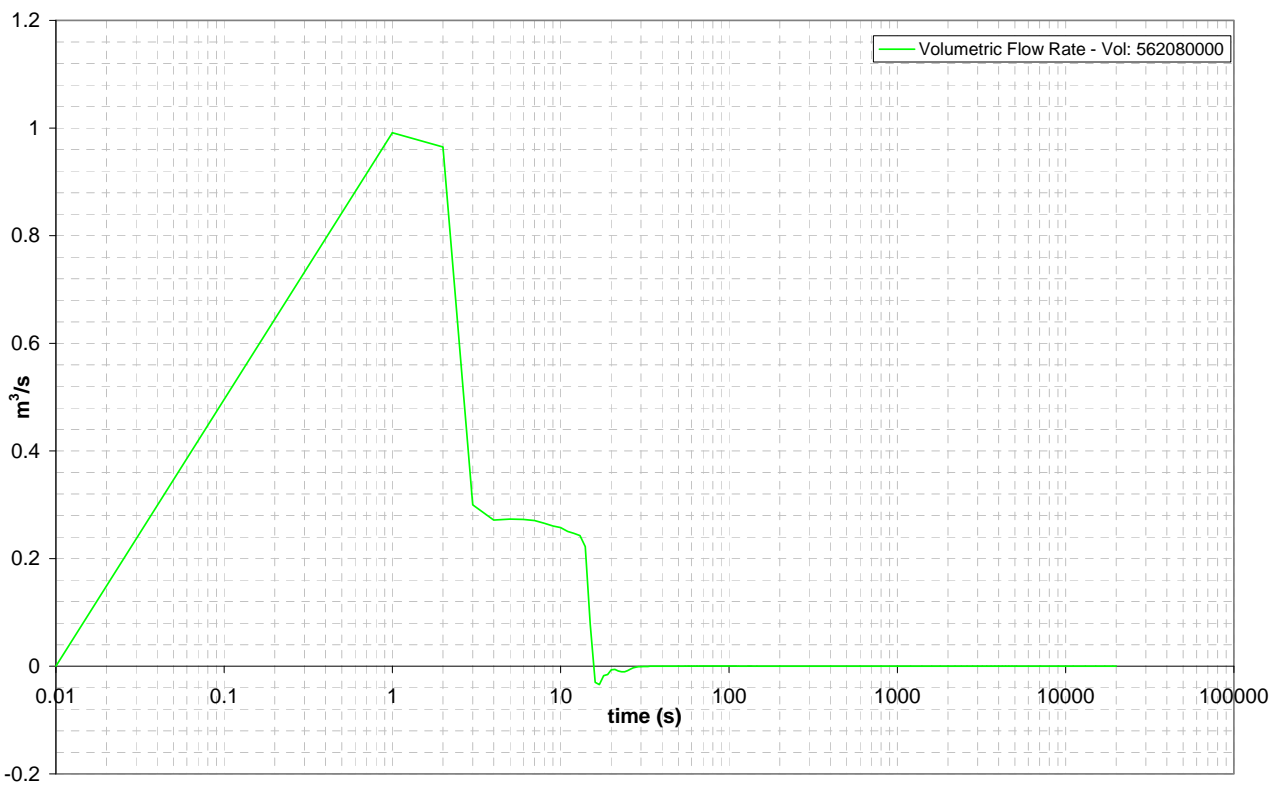

Figure 5.90: SL-B DEG BREAK LINE volumetric flowrate DOWNSTREAM

The Table 5.35 shows the minimum and maximum values of void fraction, quality, mass flowrate, liquid and gas velocities, liquid and gas temperatures, pressure and volumetric flowrate during the transient, downstream the break.

Table 5.35: Maximum and minimum values of the main variables in the SL-B DEG break line downstream of the break

SL-B DEG break line DOWNSTREAM		MIN	MAX
void fraction		0.9984	1
volume equilibrium quality		0.6499	1.0287
mass flowrate	kg/s	-0.0212	5.507
liquid velocity	m/s	-0.052	266.108
gas velocity	m/s	-2.313	436.393
liquid temperature	K	349.96	414.06
gas temperature	K	350.81	419.01
pressure	MPa	0.1024	0.4301
volumetric flowrate	m ³ /s	-0.015	2.782

The Table 5.36 describes the flow regimes in the volume before the break and in some volumes after the break. The time step changes only when there is a modification in the flow regime. The volumes highlighted in red indicate the monitoring points.

FLOW REGIMES

Table 5.36: Flow regimes function of monitoring volumes and time – SL-B DEG LINE

Time	570010000	572010000	572030000	572050000	573010000
0	HST	CHF MPR	CHF MPR	CHF MPR	CHF MPR
1	CHF MPR	CHF MPR	ANM	ANM	ANM
2	CHF MPR	CHF MPR	ANM	ANM	ANM
7	ANM	ANM	ANM	ANM	ANM
69	HST	HST	HST	HST	HST
73	HST	HST	HST	HST	CHF MPR
152	HST	HST	HST	HST	HST
153	HST	HST	HST	HST	HST
179	HST	HST	HST	HST	HST/ CHF MPR
260	HST	HST	HST	HST	CHF MPR
274	HST	CHF MPR	HST	HST	CHF MPR
304	HST	CHF MPR	HST	CHF MPR	CHF MPR
334	HST	CHF MPR	CHF MPR	CHF MPR	CHF MPR
335	CHF MPR	CHF MPR	CHF MPR	CHF MPR	CHF MPR
337	HST	CHF MPR	CHF MPR	CHF MPR	CHF MPR
344	CHF MPR	CHF MPR	CHF MPR	CHF MPR	CHF MPR
345	HST	CHF MPR	CHF MPR	CHF MPR	CHF MPR
19180	CHF MPR	CHF MPR	CHF MPR	CHF MPR	CHF MPR
19520	CHF MPR	HST	CHF MPR	CHF MPR	CHF MPR
19530	HST	HST	CHF MPR	CHF MPR	CHF MPR
19850	CHF MPR	HST	CHF MPR	CHF MPR	CHF MPR
19860	HST	HST	CHF MPR	CHF MPR	CHF MPR
19990	CHF MPR	HST	CHF MPR	CHF MPR	CHF MPR

5.4.1.1 Synthesis of achievements for the SL DEG break

As detailed in [4], the SL-B DEG line is interested by flow only in the early phases of the transient, until the Steam Generators are isolated and the break valve on the main line (SL-B) is completely closed. As shown in Figure 5.81 and Table 5.34, the mass flowrate is appreciable only in the first 10 seconds. Moreover, the void fraction is high both upstream and downstream of the valve, during the whole transient, as shown in Figure 5.85 and Figure 5.89.

This avoids the need to install a spool piece on the SL-B DEG break line.

For the SL-B DEG break line, a Venturi meter will be installed upstream of the break.

5.4.2 SL SPLIT break line

Table 5.37 describes the nodalization of the SL-B SPLIT BREAK line: one volume upstream the valve, the junction (valve) that represents the break, six volumes downstream the valve and the nozzle before the tank. The main variables and the flow regimes have been taken in the volumes indicated by “*”.

Table 5.37: Description of the volumes for the SL-B SPLIT break

UPSTREAM	MOTOR VALVE	DOWNSTRAM	END OF LINE
575010000	576000000	577010000	578010000
		577020000	
		577030000	
		577040000 (*)	
		577050000	
		577060000	

UPSTREAM

The Figure 5.91, Figure 5.92, Figure 5.93, Figure 5.94 and Figure 5.95 represent the mass flowrate, the liquid and gas velocities, the pressure, the liquid and gas temperatures, the void fraction and the quality of the volume 575010000, upstream the break in the SL-B SPLIT line,

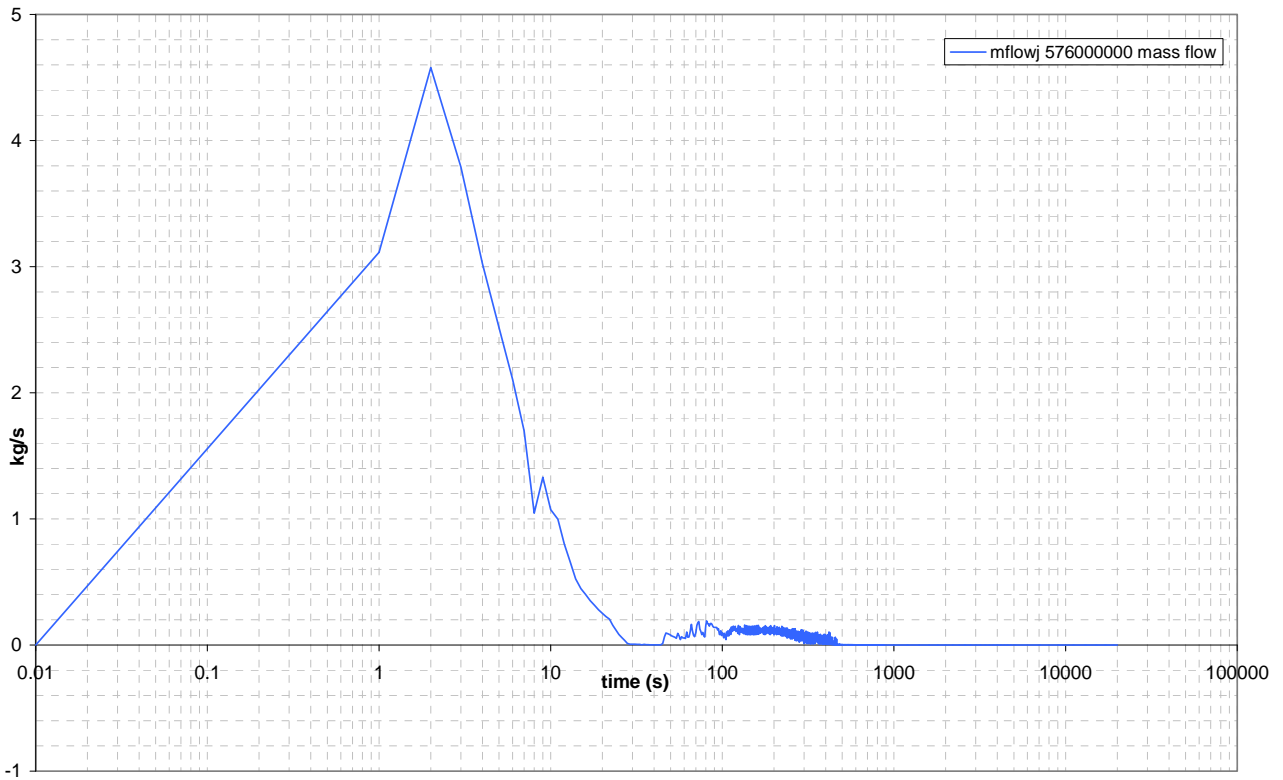

Figure 5.91: SL-B SPLIT BREAK LINE mass flowrate

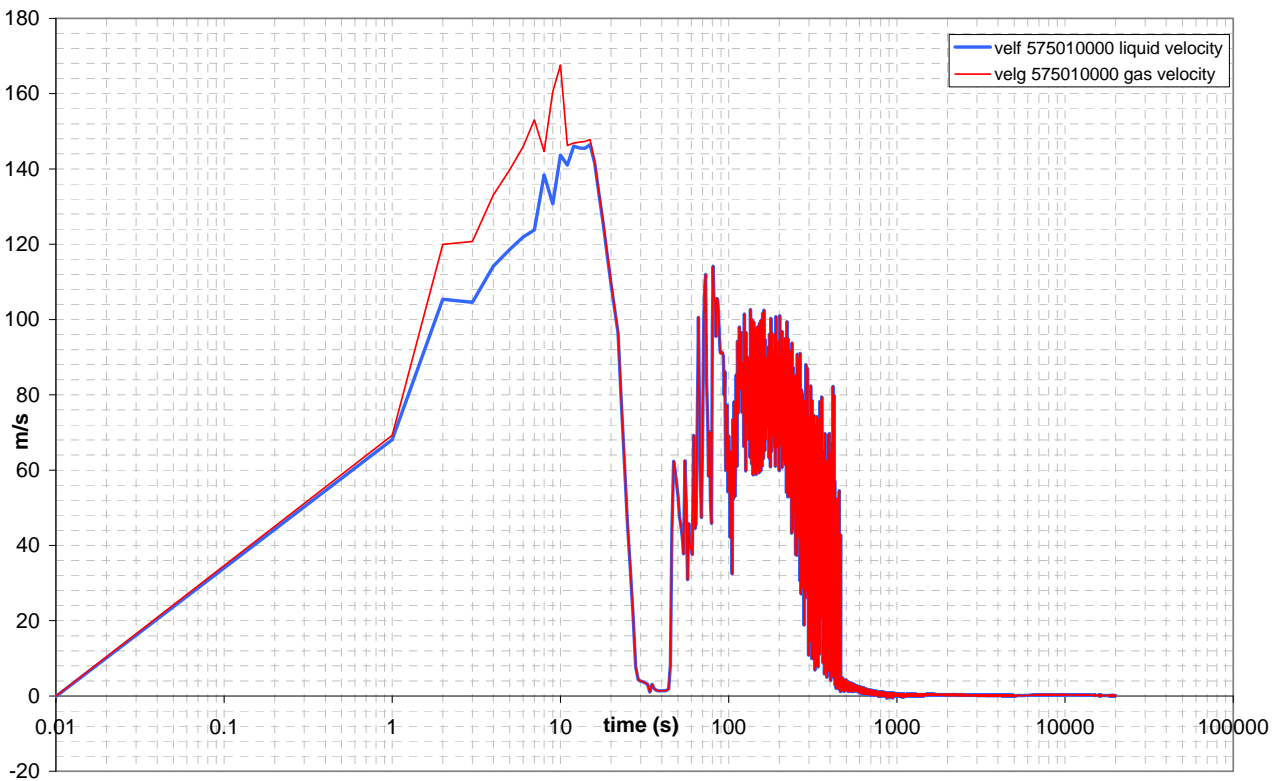

Figure 5.92: SL-B SPLIT BREAK LINE liquid and gas velocities UPSTREAM

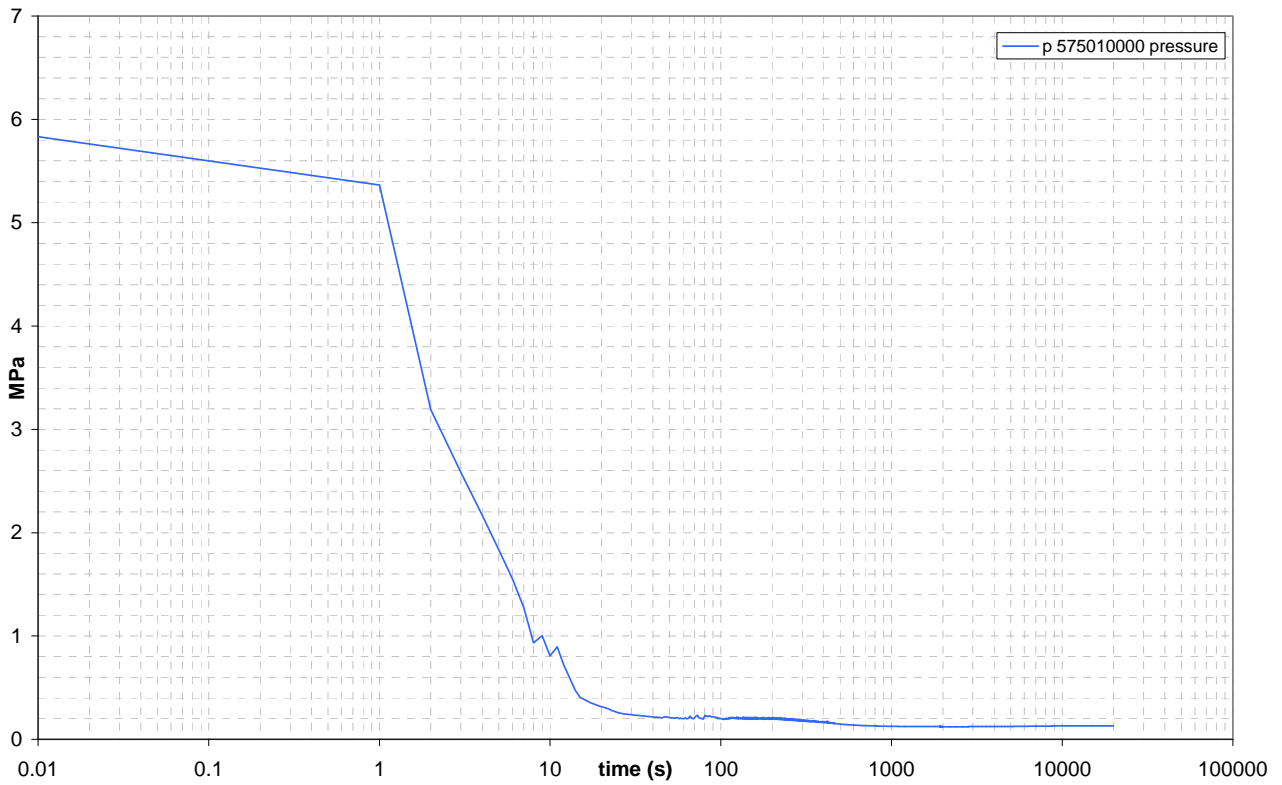

Figure 5.93: SL-B SPLIT BREAK LINE pressure UPSTREAM

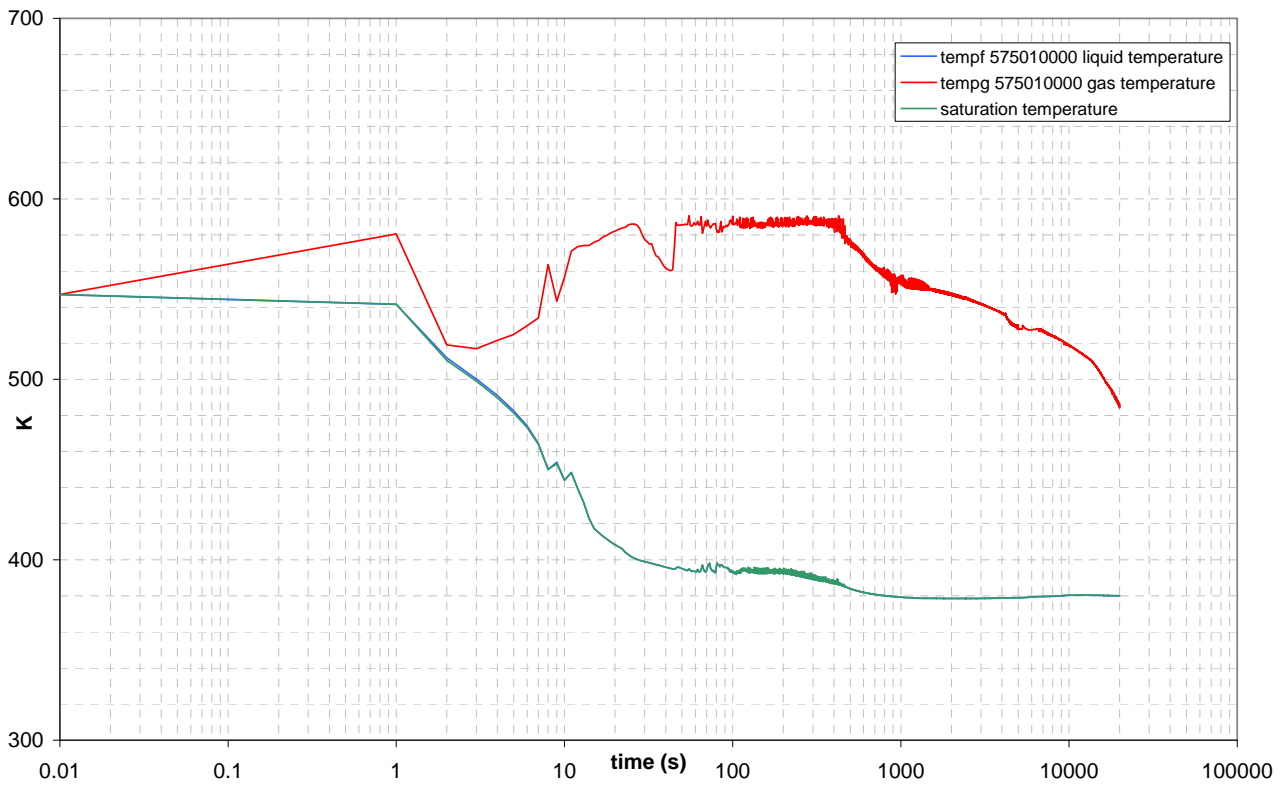

Figure 5.94: SL-B SPLIT BREAK LINE liquid and gas temperatures UPSTREAM

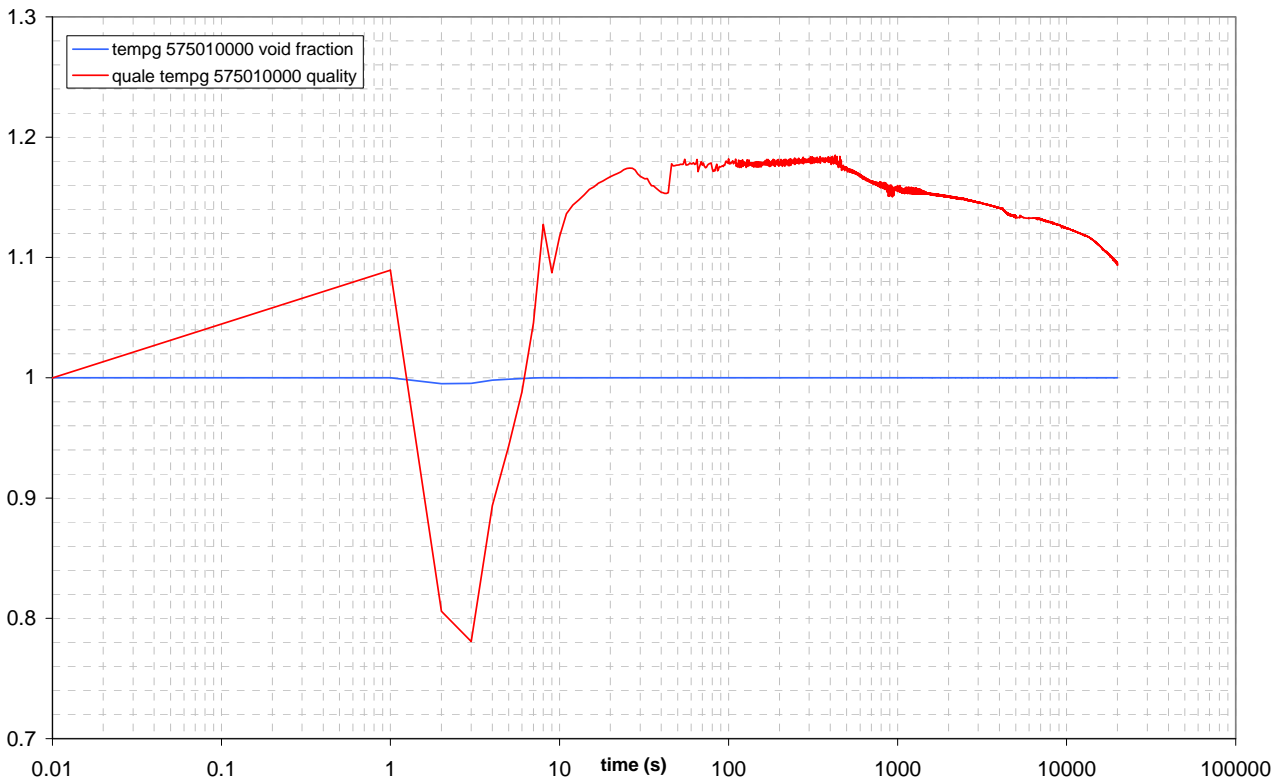

Figure 5.95: SL-B SPLIT BREAK LINE void fraction and quality UPSTREAM

Table 5.38: Maximum and minimum values of the main variables in the SL-B SPLIT break line upstream of the break

SL SPLIT break line UPSTREAM		MIN	MAX
void fraction		0.9950	1.0000
volume equilibrium quality		0.7808	1.1852
mass flowrate	kg/s	-0.0005	4.5788
liquid velocity	m/s	-0.5612	146.4540
gas velocity	m/s	-0.5612	167.5600
liquid temperature	K	378.4970	546.8500
gas temperature	K	517.0160	590.6430
pressure	MPa	0.1224	5.8335

The Table 5.38 shows the minimum and maximum values of void fraction, quality, mass flowrate, liquid and gas velocities, liquid and gas temperatures, pressure during the transient, upstream the break.

DOWNSTREAM

Figure 5.96, Figure 5.97, Figure 5.98 and Figure 5.99 represent the liquid and gas velocities, the pressure, the liquid and gas temperatures, the void fraction and the quality of the volume 577040000, downstream the break in the SL-B SPLIT line. Figure 5.100 shows the volumetric flowrate calculated using the area of the pipe, the void fraction, the gas and liquid velocities.

The mass flowrate is not shown because it is the same downstream and upstream of the break.

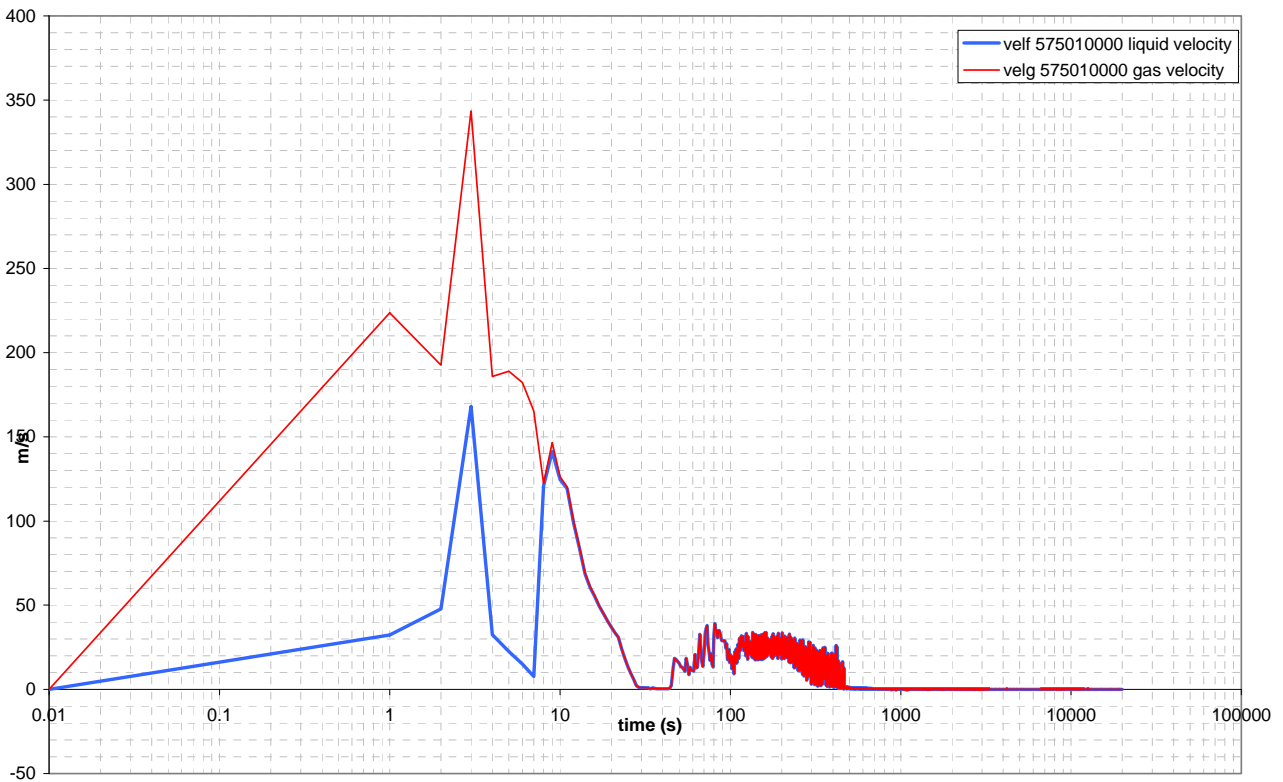

Figure 5.96: SL-B SPLIT BREAK LINE liquid and gas velocities DOWNSTREAM

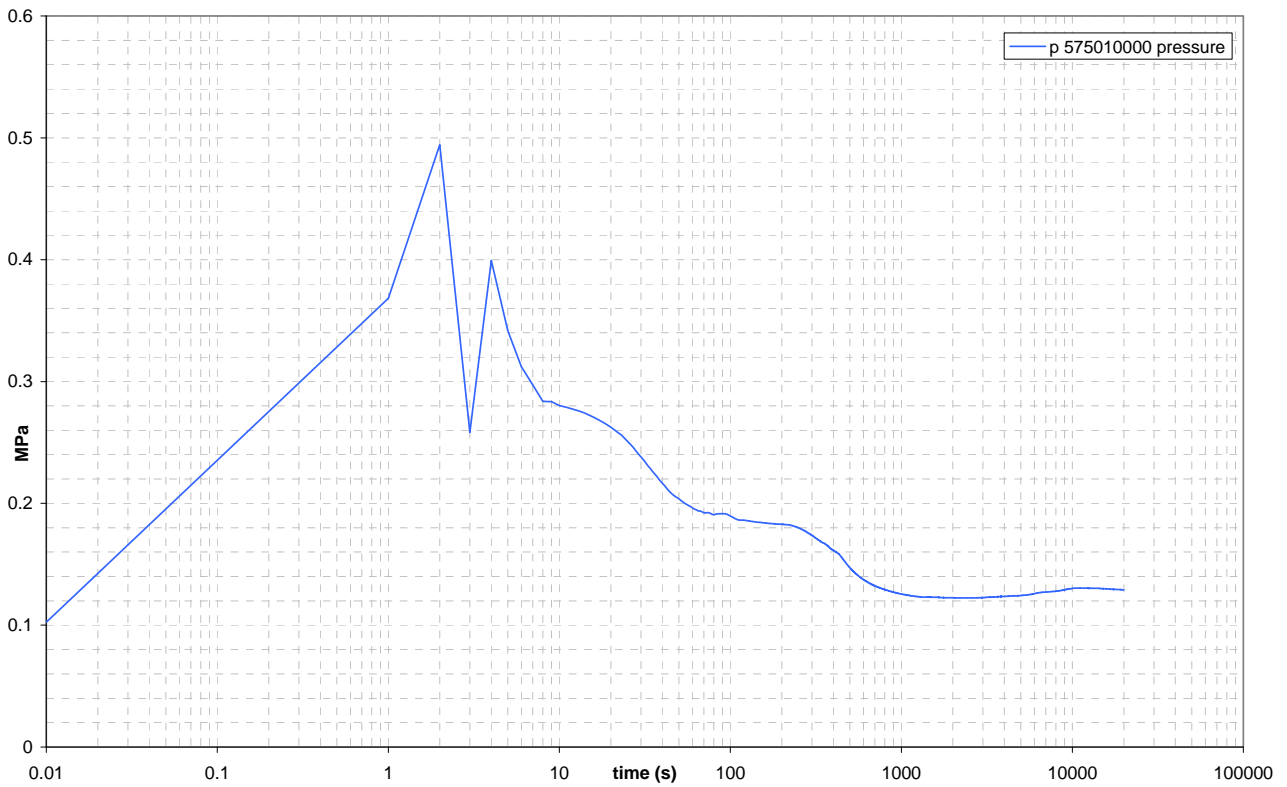

Figure 5.97: SL-B SPLIT BREAK LINE pressure DOWNSTREAM

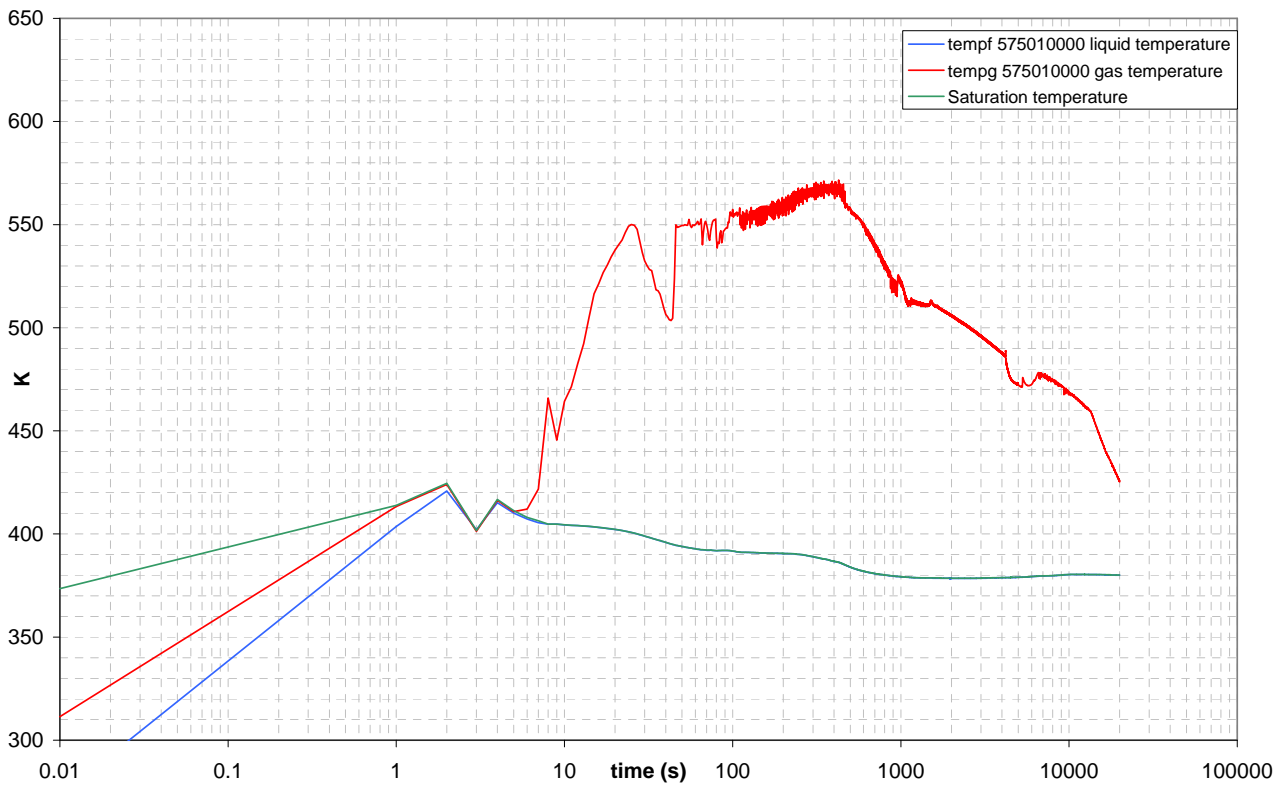

Figure 5.98: SL-B SPLIT BREAK LINE liquid and gas temperatures DOWNSTREAM

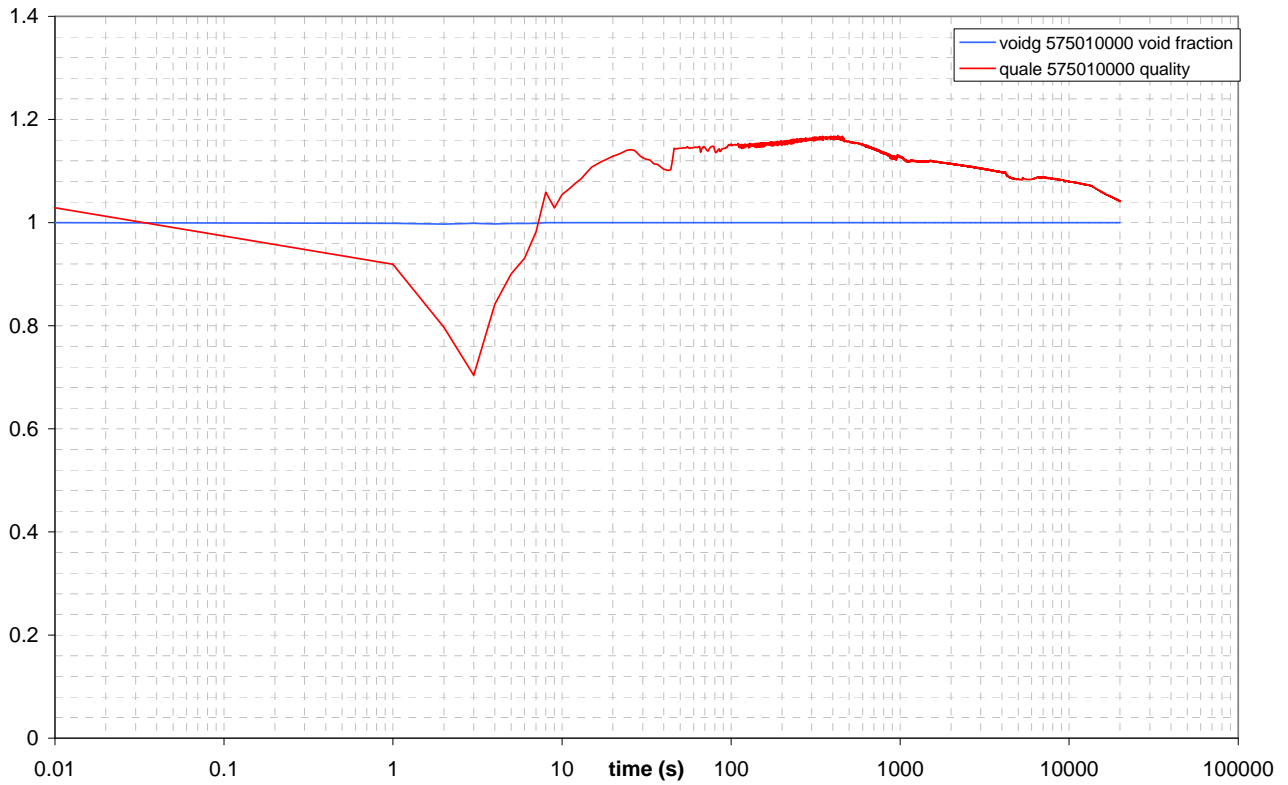

Figure 5.99: SL-B SPLIT BREAK LINE void fraction and quality DOWNSTREAM

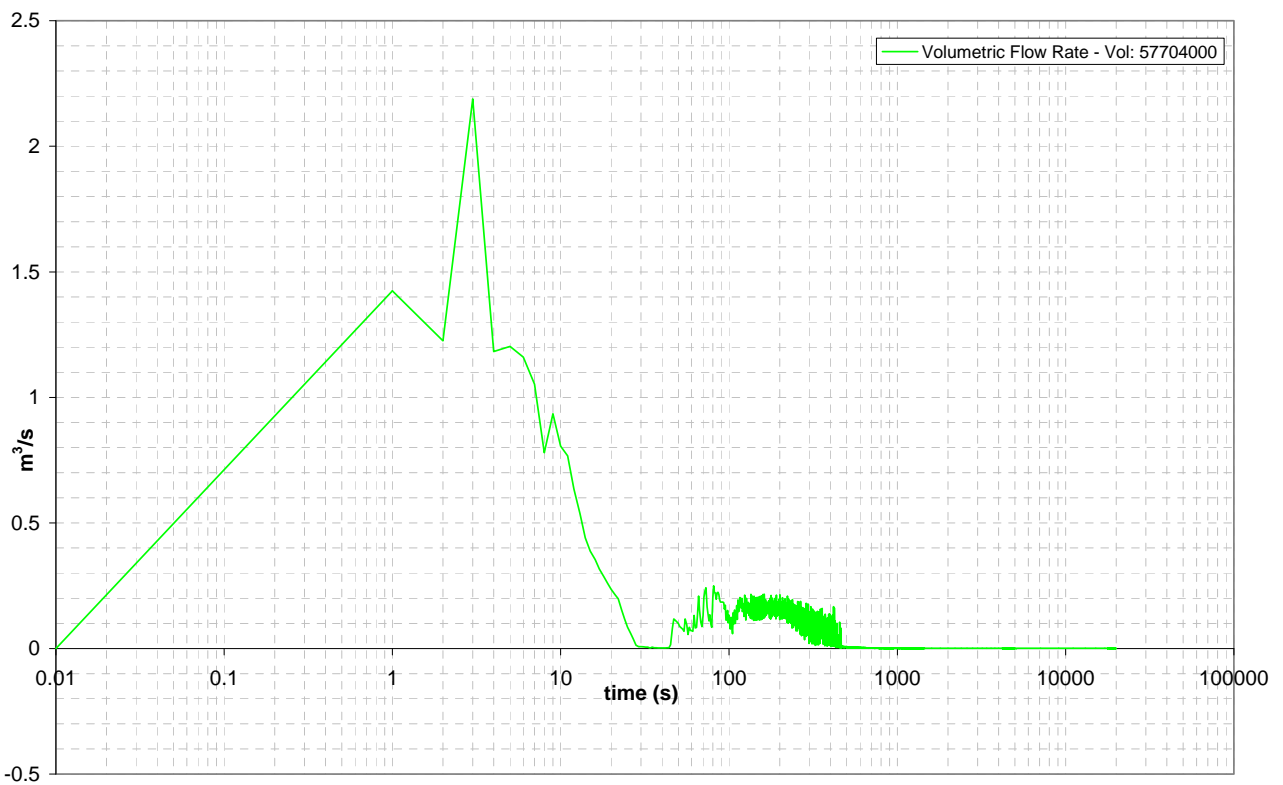

Figure 5.100: SL-B SPLIT BREAK LINE volumetric flowrate DOWNSTREAM

Table 5.39 shows the minimum and maximum values of void fraction, quality, mass flowrate, liquid and gas velocities, liquid and gas temperatures, pressure and volumetric flowrate during the transient, downstream the break

Table 5.39: Maximum and minimum values of the main variables in the
SL-B SPLIT break line downstream of the break

SL SPLIT break line DOWNSTREAM		MIN	MAX
void fraction		0.9971	1
volume equilibrium quality		0.6499	1.0287
mass flowrate	kg/s	-0.00053	4.5788
liquid velocity	m/s	-0.172	168.017
gas velocity	m/s	-0.172	343.500
liquid temperature	K	378.50	420.82
gas temperature	K	401.23	571.58
pressure	MPa	0.1024	0.4941
volumetric flowrate	m ³ /s	-0.001	2.189

Table 5.40 describes the flow regimes in the volume before the break and in some volumes after the break. The time step changes only when there is a modification in the flow regime. The volumes emphasized by red indicate the monitoring points.

FLOW REGIME

Table 5.40: Flow regimes function of monitoring volumes and time – SL-B SPLIT LINE

Time	575010000	577010000	577030000	577060000	578010000
0	HST	CHF MPR	CHF MPR	CHF MPR	CHF MPR
1	CHF MPR	CHF MPR	ANM	ANM	ANM
2	ANM	ANM	ANM	ANM	ANM
6	ANM	ANM	ANM	ANM	ANM
7	ANM	CHF MPR	ANM	ANM	ANM
8	CHF MPR	CHF MPR	CHF MPR	CHF MPR	CHF MPR
9	CHF MPR	CHF MPR	CHF MPR	CHF MPR	ANM
19	CHF MPR	CHF MPR	CHF MPR	CHF MPR	CHF MPR
26	CHF MPR	CHF MPR	CHF MPR	CHF MPR	CHF MPR
27	HST	CHF MPR	CHF MPR	CHF MPR	CHF MPR
19990	CHF MPR	CHF MPR	CHF MPR	CHF MPR	CHF MPR

5.4.2.1 Synthesis of achievements for the SL SPLIT break

As detailed in [4], the SL-B SPLIT line mass flow is limited to the early phases of the transient, due to suction of steam contained in the SG-B tubes towards the break and later due to vaporization of water entered the SG-B from the EHRS-B cold leg. As shown in Figure 5.91 and Table 5.38, the mass flowrate is appreciable only in the first 30 seconds. Moreover, the void fraction is high both upstream and downstream of the valve, during the whole transient, as shown in Figure 5.95 and Figure 5.99.

This avoids the need to install a spool piece on the SL-B SPLIT break line.

For the SL-B SPLIT break line, a Venturi meter will be installed upstream of the break.

5.4.3 ADS lines

The ADS intervention is not foreseen in the SL-B break transient.

5.5 FL BREAK TEST

The 12 inch equivalent FL-B DEG break is one of the secondary side break that may occur, inside the containment, in the IRIS plant [1].

It is a liquid side break at the SG-B inlet and it is simulated in SPES3 by opening the valve system on the break lines departing from the FL-B, located between the SG-B inlet and the EHRS-B cold leg connection.

5.5.1 FL DEG break line

The **Errore. L'autoriferimento non è valido per un segnalibro.** describes the nodalization of the FL-B DEG BREAK line: one volume upstream of the valve, the junction (valve) that represents the break, eleven volumes downstream of the valve and the nozzle before the tank (end of line). The main variables and the flow regimes have been taken in the volumes indicated by “*”.

Table 5.41: Description of the volumes for the FL-B DEG break

UPSTREAM	MOTOR VALVE	DOWNSTRAM	END OF LINE
560010000 (*)	561000000	562010000	563010000
		562020000	
		562030000	
		562040000	
		562050000	
		562060000	
		562070000	
		562080000 (*)	
		562090000	
		562100000	
		562110000	

UPSTREAM

The Figure 5.101, Figure 5.102, Figure 5.103, Figure 5.104 and Figure 5.105 represent the mass flowrate, the liquid and gas velocities, the pressure, the liquid and gas temperatures, the void fraction and the quality of the volume 660010000, upstream of the break in the FL-B DEG line, Figure 4.10.

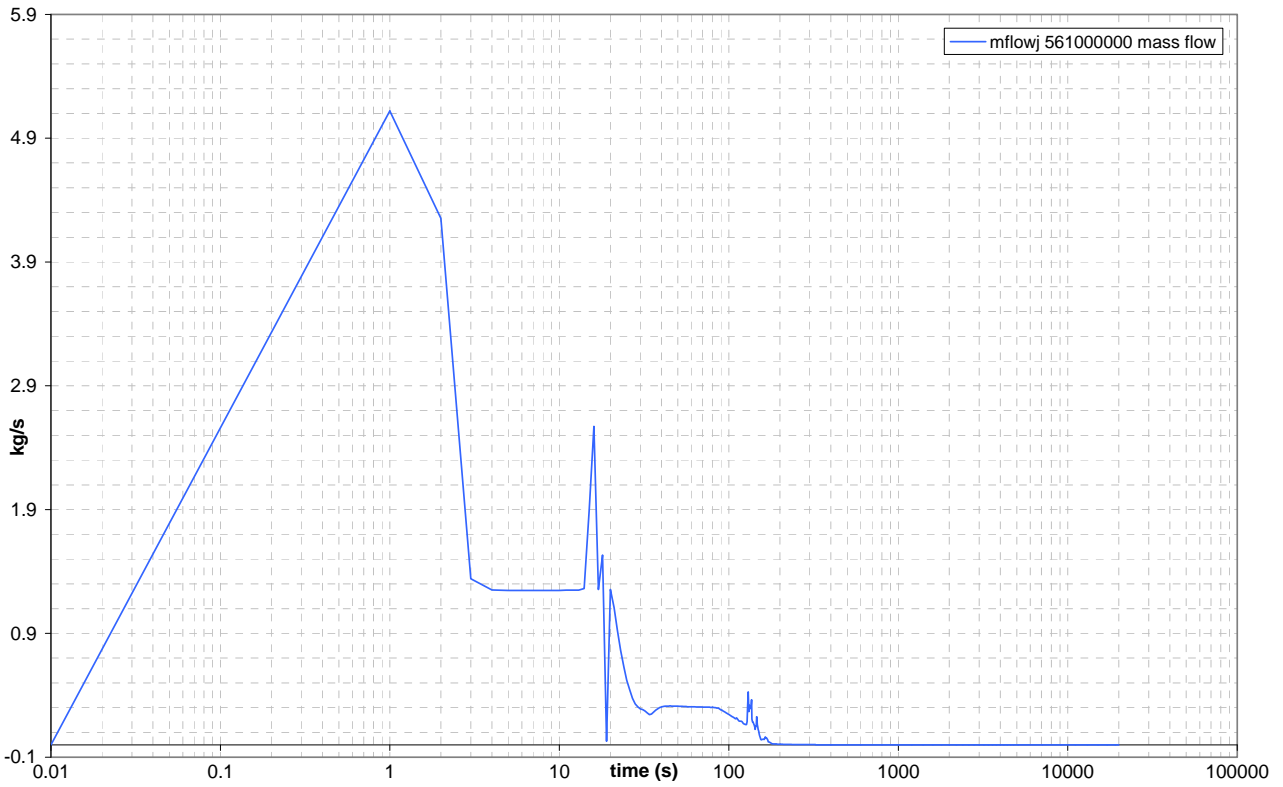

Figure 5.101: FL-B DEG BREAK LINE mass flowrate

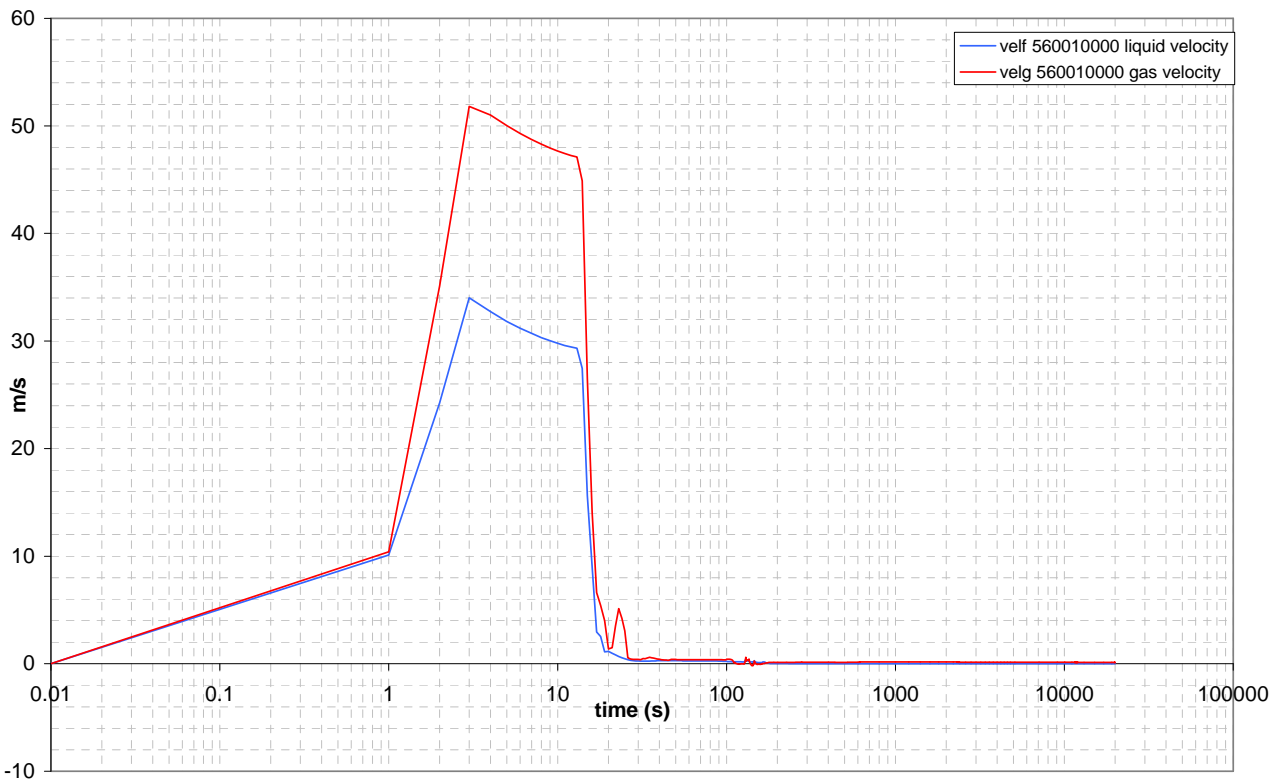

Figure 5.102: FL-B DEG BREAK LINE liquid and gas velocities UPSTREAM

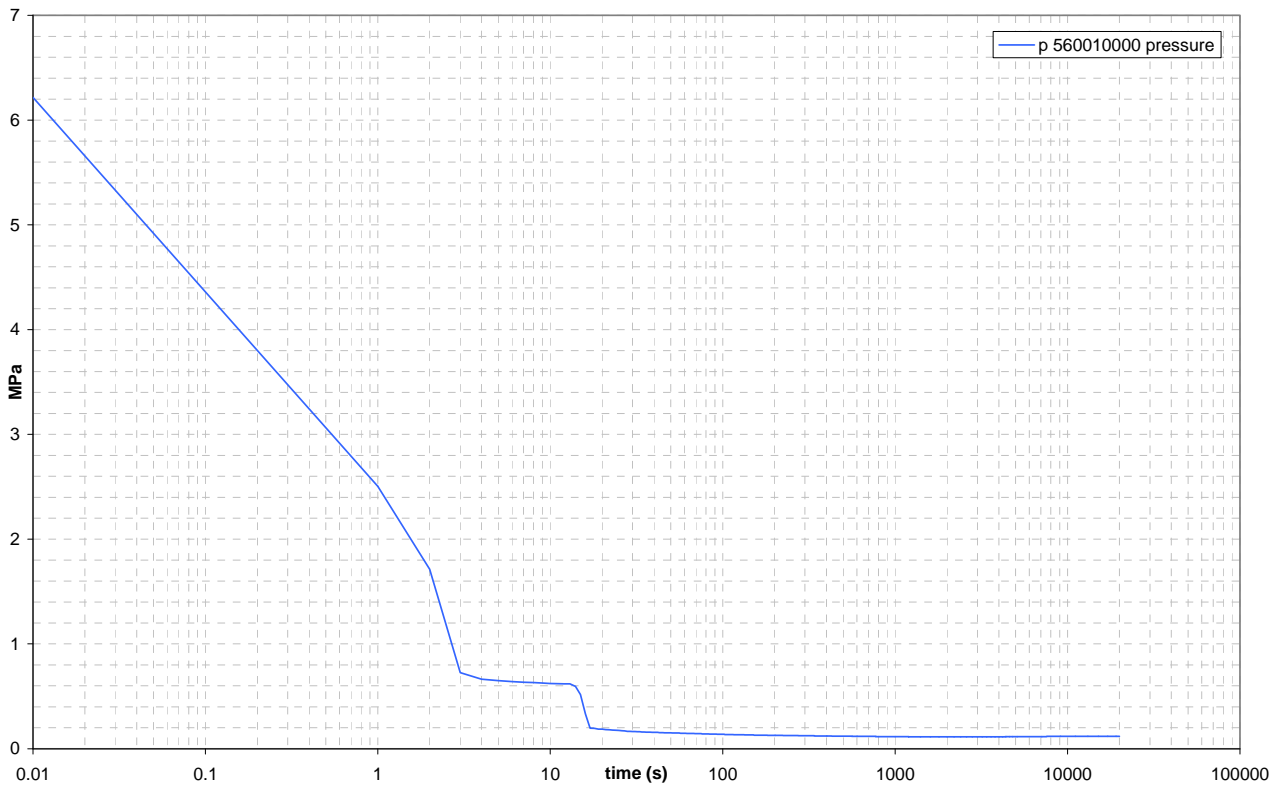

Figure 5.103: FL-B DEG BREAK LINE pressure UPSTREAM

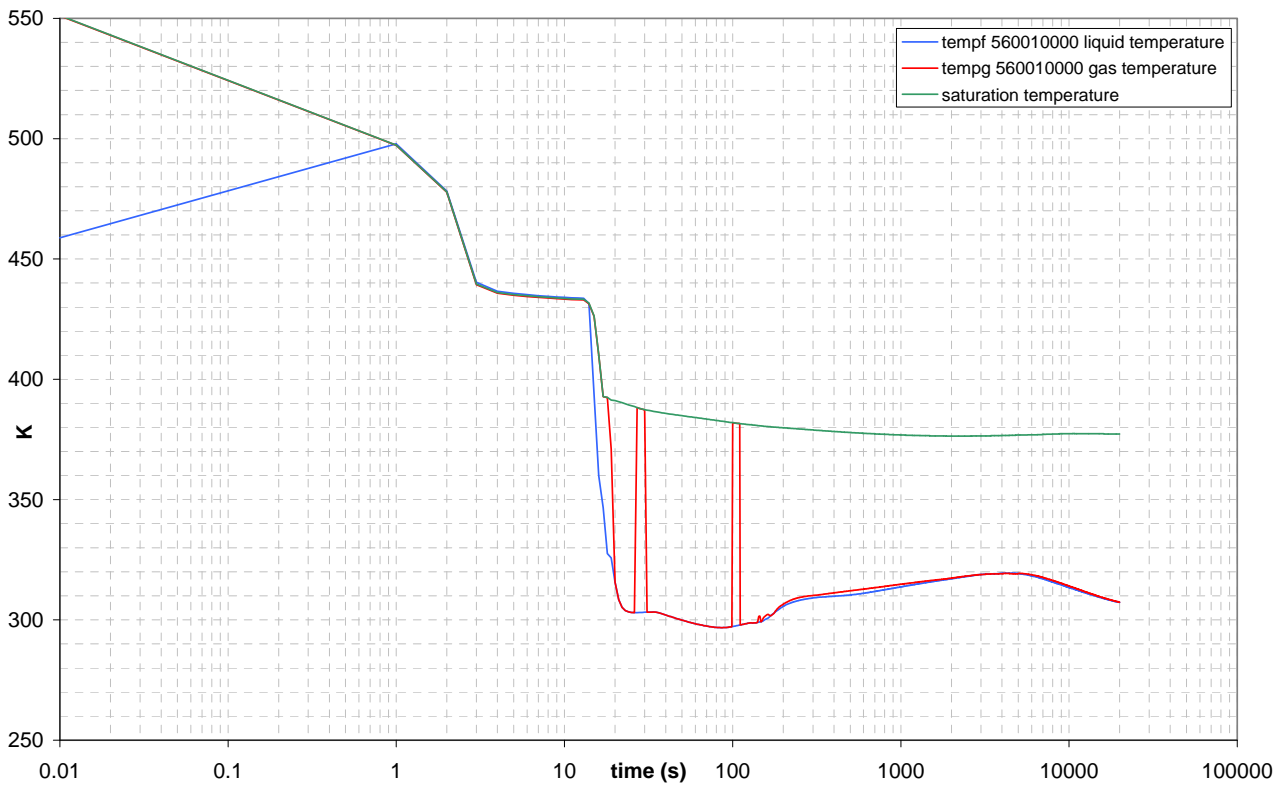

Figure 5.104: FL-B DEG BREAK LINE liquid and gas temperatures UPSTREAM

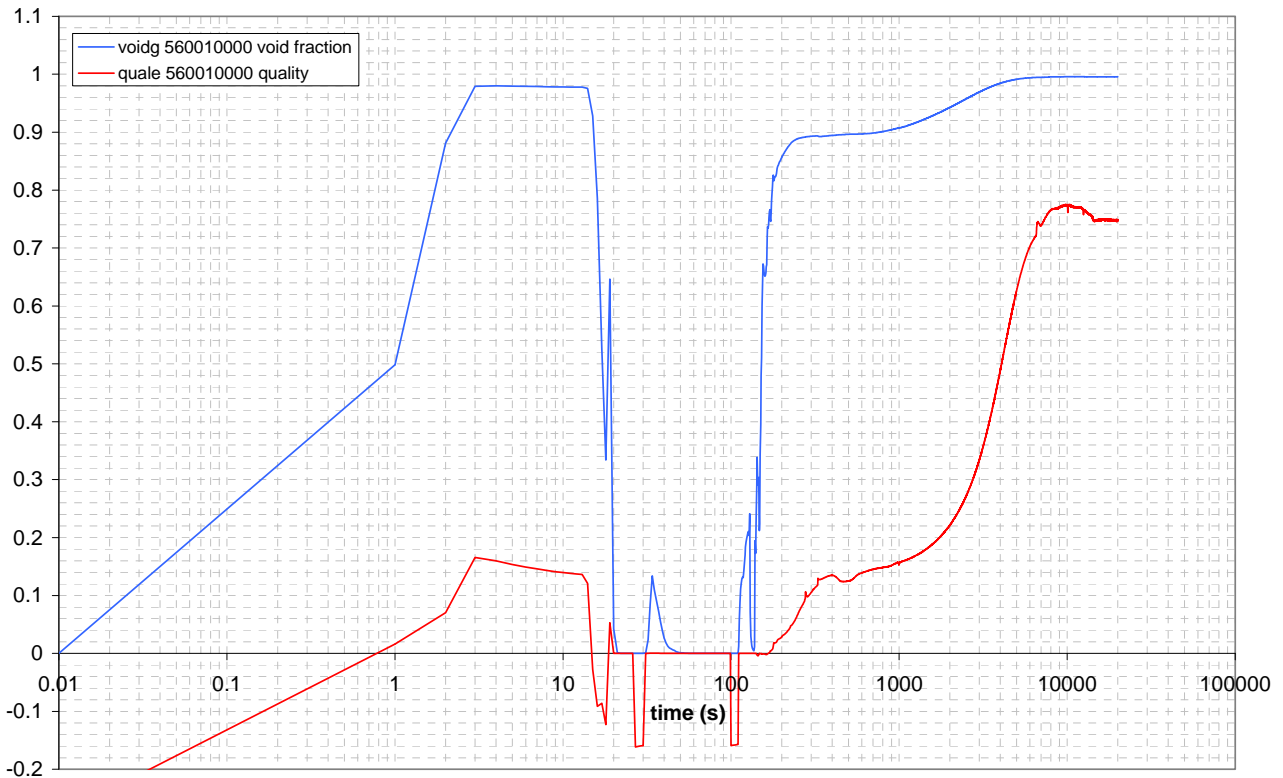

Figure 5.105: FL-B DEG BREAK LINE void fraction and quality UPSTREAM

Table 5.42: Maximum and minimum values of the main variables in the
FL DEG break line upstream of the break

FL DEG break line UPSTREAM		MIN	MAX
void fraction		0	0.9813
volume equilibrium quality		-0.2799	0.4441
mass flowrate	kg/s	0	5.1198
liquid velocity	m/s	0	34.0266
gas velocity	m/s	-0.1924	51.8101
liquid temperature	K	296.7980	497.8300
gas temperature	K	296.7980	551.0530
pressure	MPa	0.1137	6.2161

The Table 5.42 shows the minimum and maximum values of void fraction, quality, mass flowrate, liquid and gas velocities, liquid and gas temperatures, pressure during the transient, upstream of the break.

DOWNSTREAM

The Figure 5.106, Figure 5.107, Figure 5.108 and Figure 5.109 represent the liquid and gas velocities, the pressure, the liquid and gas temperatures, the void fraction and the quality of the volume 562080000 downstream of the break in the FL-B DEG line, Figure 4.10. Figure 5.110 shows the volumetric flowrate calculated using the area of the pipe, the void fraction, the gas and liquid velocities.

The mass flowrate is not shown because it is the same downstream and upstream the break.

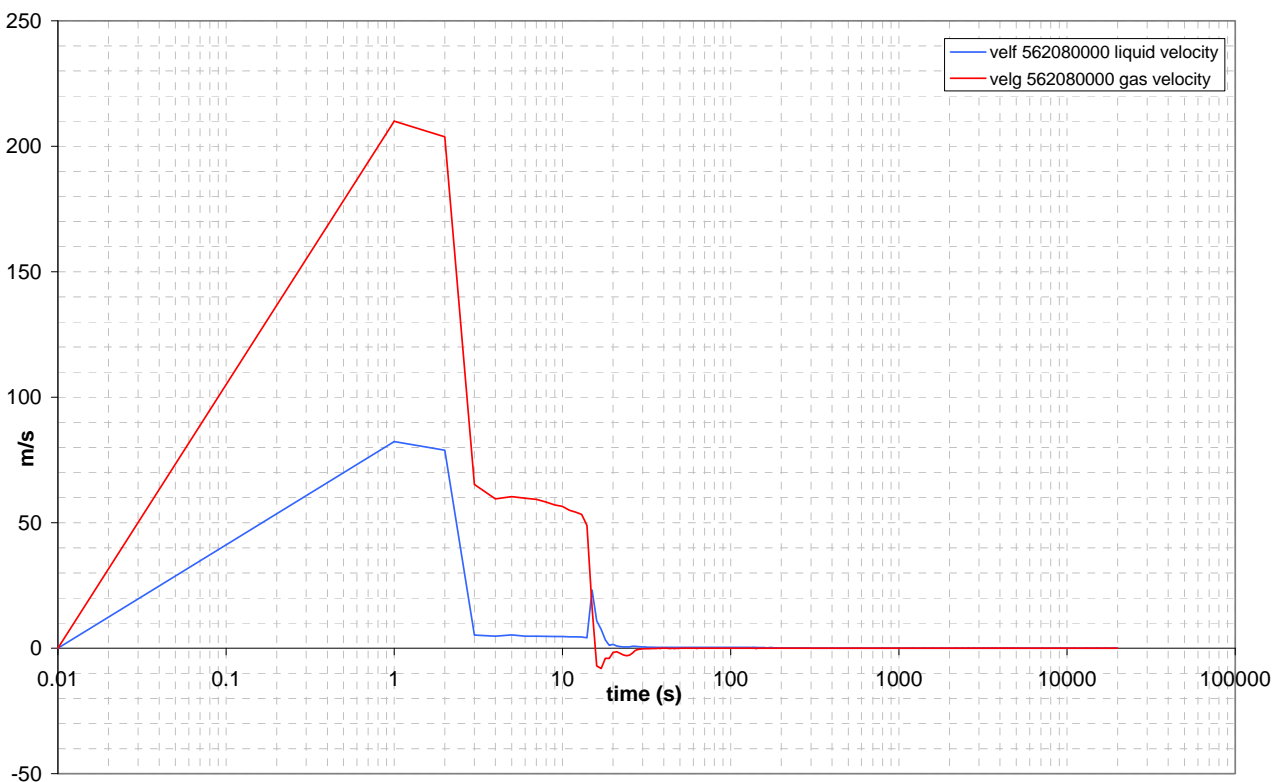

Figure 5.106: FL-B DEG BREAK LINE liquid and gas velocities DOWNSTREAM

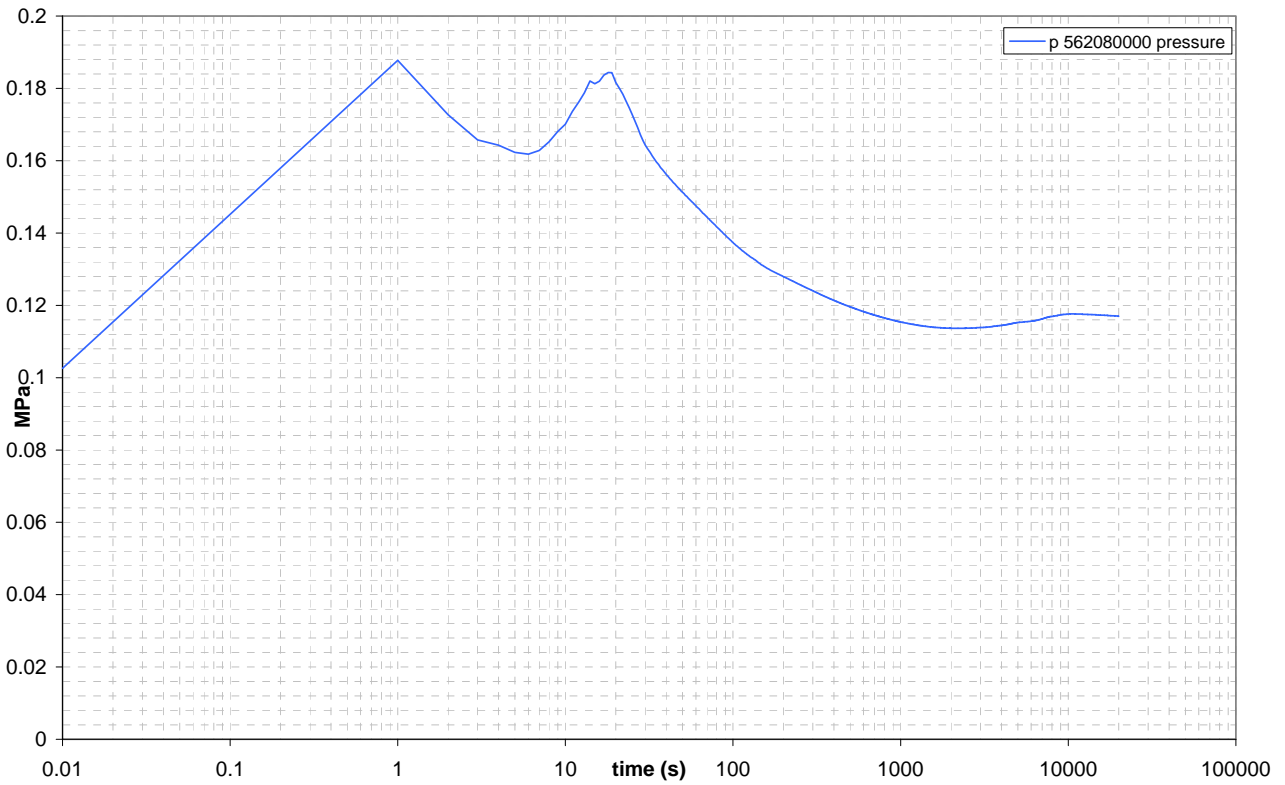

Figure 5.107: FL-B DEG BREAK LINE pressure DOWNSTREAM

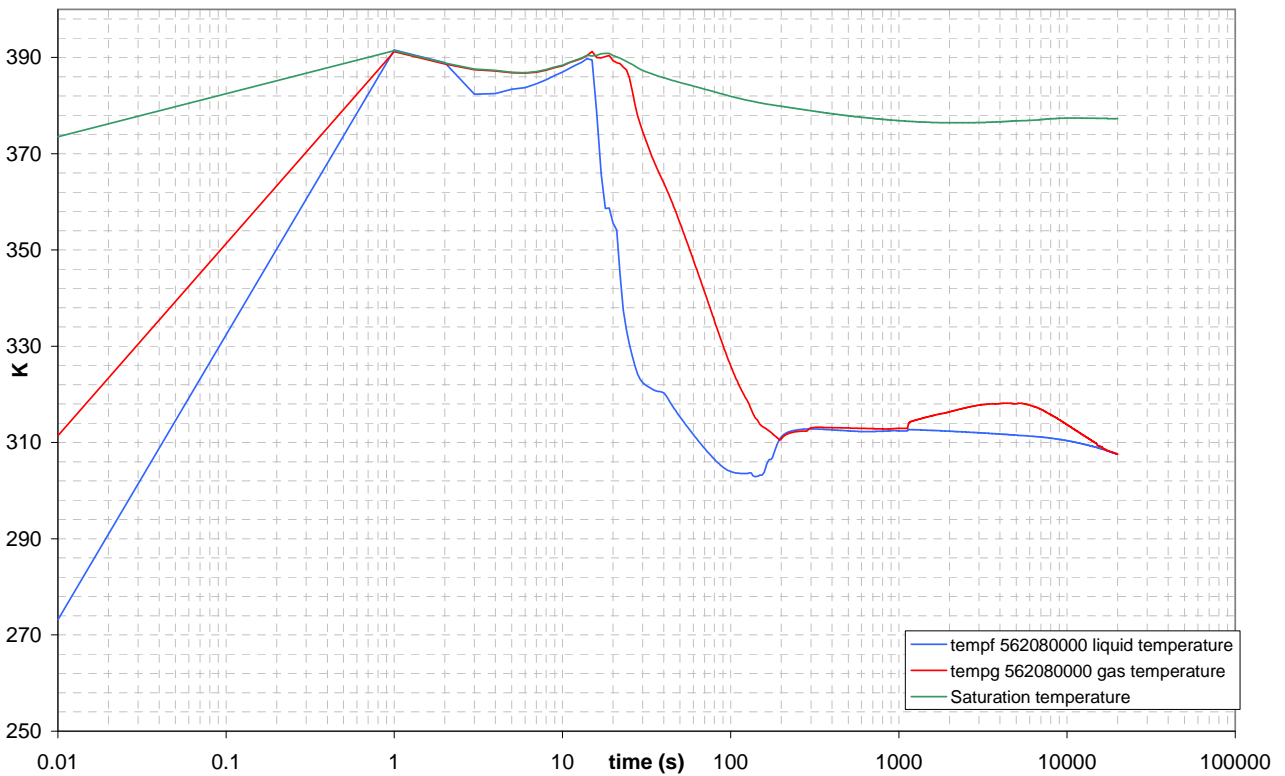

Figure 5.108: FL-B DEG BREAK LINE liquid and gas temperatures DOWNSTREAM



Figure 5.109: FL-B DEG BREAK LINE void fraction and quality DOWNSTREAM

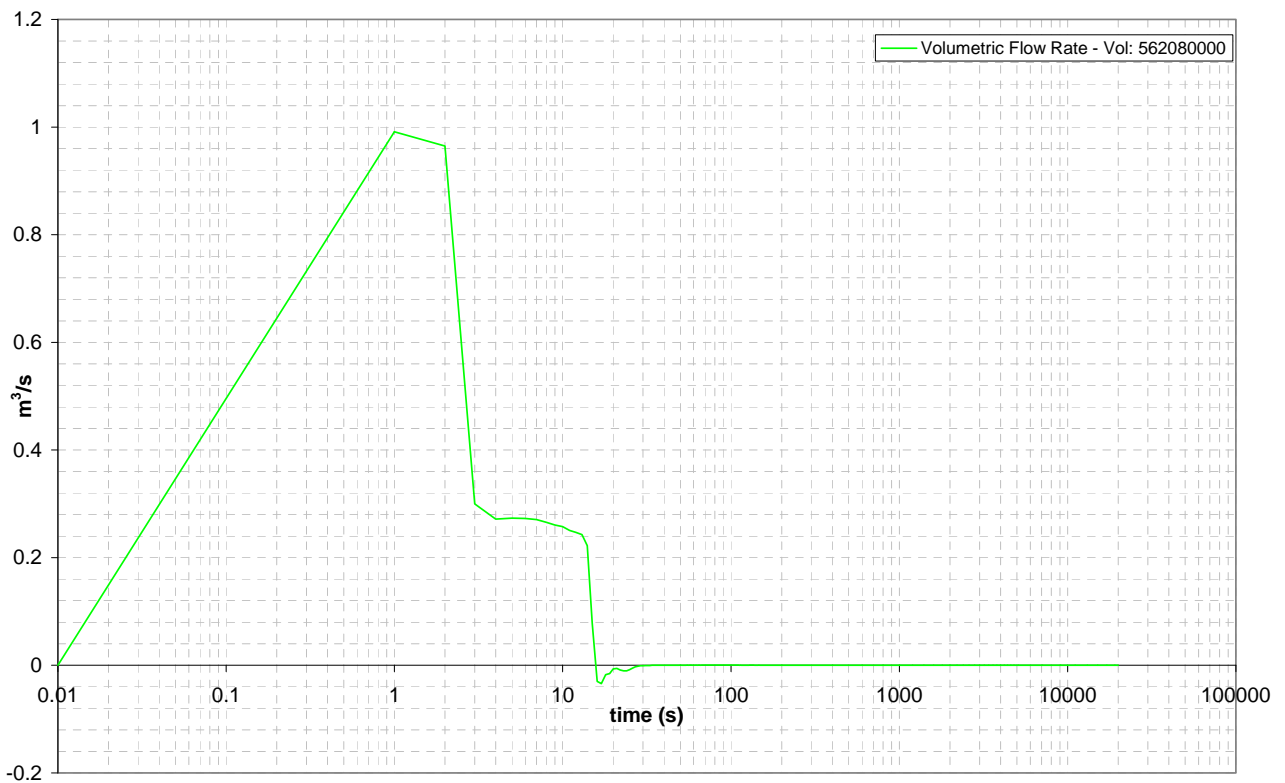

Figure 5.110: FL-B DEG BREAK LINE volumetric flowrate DOWNSTREAM

Table 5.43 shows the minimum and maximum values of void fraction, quality, mass flowrate, liquid and gas velocities, liquid and gas temperatures, pressure and volumetric flowrate during the transient, downstream of the break.

Table 5.43: Maximum and minimum values of the main variables in the
FL-B DEG break line downstream of the break

FL-B DEG break line DOWNSTREAM		MIN	MAX
void fraction		0.676	1
volume equilibrium quality		-0.0974	1.0286
mass flowrate	kg/s	0	5.12
liquid velocity	m/s	0	82.345
gas velocity	m/s	-8.084	210.010
liquid temperature	K	302.92	391.56
gas temperature	K	307.61	391.27
pressure	MPa	0.1026	0.1877
volumetric flowrate	m ³ /s	-0.034	0.991

Table 5.44 describes the flow regimes in the volume before the break and in some volumes after the break. The time step changes only when there is a modification in the flow regime. The volumes emphasized by red indicate the monitoring points.

FLOW REGIMES

Table 5.44: Flow regimes function of monitoring volumes and time – FL-B DEG LINE

Time	560010000	562010000	562080000	562110000	563010000
0	BBY	CHF MPR	CHF MPR	CHF MPR	CHF MPR
1	BBY	ANM	ANM	ANM	ANM
2	ANM	ANM	ANM	ANM	ANM
10	ANM	ANM	ANM	ANM	ANM
14	ANM	ANM	ANM	ANM	HST
15	ANM	ANM	HST	HST	HST
20	HST	HST	HST	HST	HST
32	BBY	HST	HST	HST	HST
44	HST	HST	HST	HST	HST
111	BBY	HST	HST	HST	HST
133	HST	HST	HST	HST	HST
134	BBY	HST	HST	HST	HST
135	HST	HST	HST	HST	HST
138	BBY	HST	HST	HST	HST
19990	HST	HST	HST	HST	HST

5.5.1.1 Synthesis of achievements for the FL DEG break

As detailed in [4], the FL-B DEG line is interested by flow in the early phases of the transient, until the break valve on the main line (FL-B) is completely closed, until the Steam Generators are isolated and until the EHRS-B heat exchanger is empty after its actuation. As shown in Figure 5.101 and Table 5.42, the mass flowrate is appreciable only in the first 100 seconds. The void fraction upstream of the break shows strong variations between 1 and 0, in the phase of water flow coming from the EHRS-B end exiting through the DEG line, Figure 5.105. Such mass flow can be measured through the EHRS-B cold leg orifice. Instead, the void fraction downstream of the valve is high during the whole transient, Figure 5.109.

This avoids the need to install a spool piece on the FL-B DEG break line.

For the FL-B DEG break line, a Venturi meter will be installed upstream of the break.

5.5.2 FL SPLIT break line

Errore. L'autoriferimento non è valido per un segnalibro. describes the nodalization of the FL-B SPLIT BREAK line: one volume upstream of the valve, the junction (valve) that represents the break, eleven volumes downstream of the valve and the nozzle before the tank (end of line). The main variables and the flow regimes have been taken in the volumes indicated by “*”.

Table 5.45: Description of the volumes for the FL-B SPLIT break

UPSTREAM	MOTOR VALVE	DOWNSTRAM	END OF LINE
565010000 (*)	566000000	567010000	568010000
		567020000	
		567030000	
		567040000	
		567050000	
		567060000	
		567070000	
		567080000 (*)	
		567090000	
		567100000	
		567110000	

UPSTREAM

Figure 5.111, Figure 5.112, Figure 5.113, Figure 5.114 and Figure 5.115 represent the mass flowrate, the liquid and gas velocities, the pressure, the liquid and gas temperatures, the void fraction and the quality of the volume 565010000, upstream of the break in the FL-B SPLIT line, Figure 4.10.

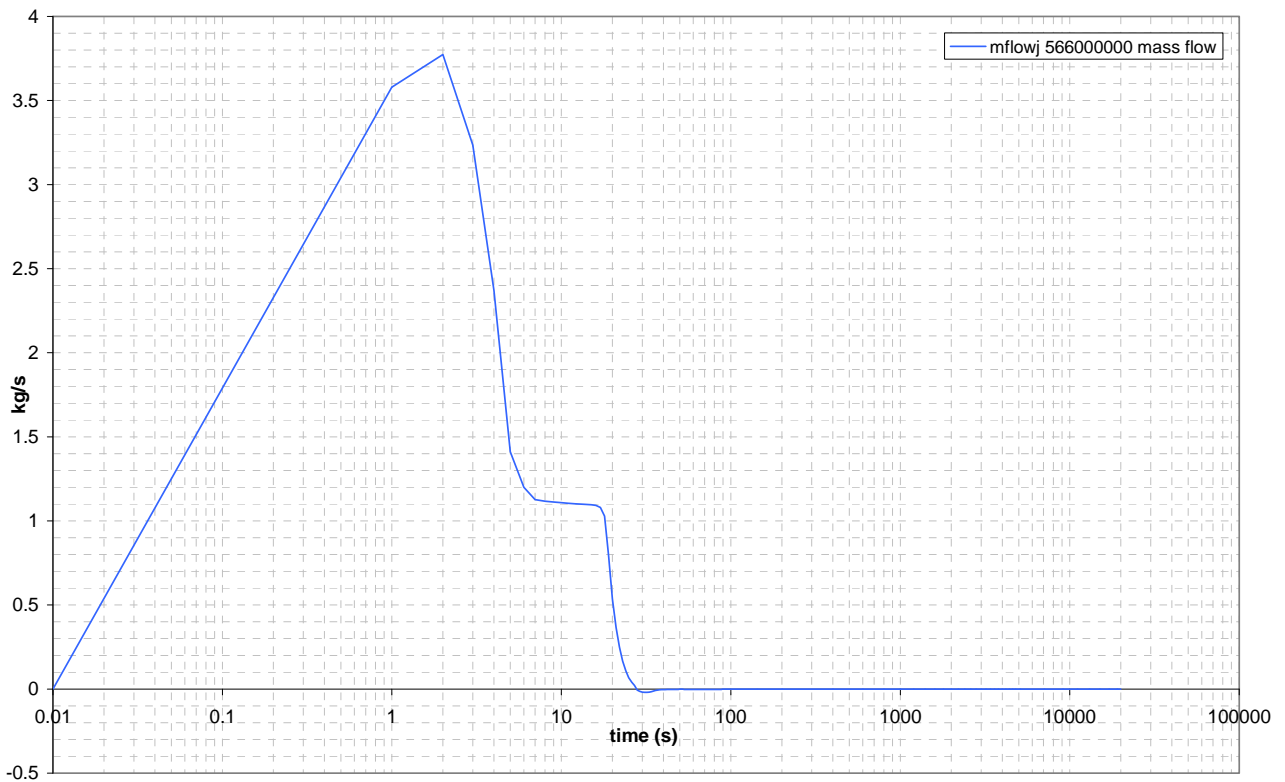

Figure 5.111: FL-B SPLIT BREAK LINE mass flowrate

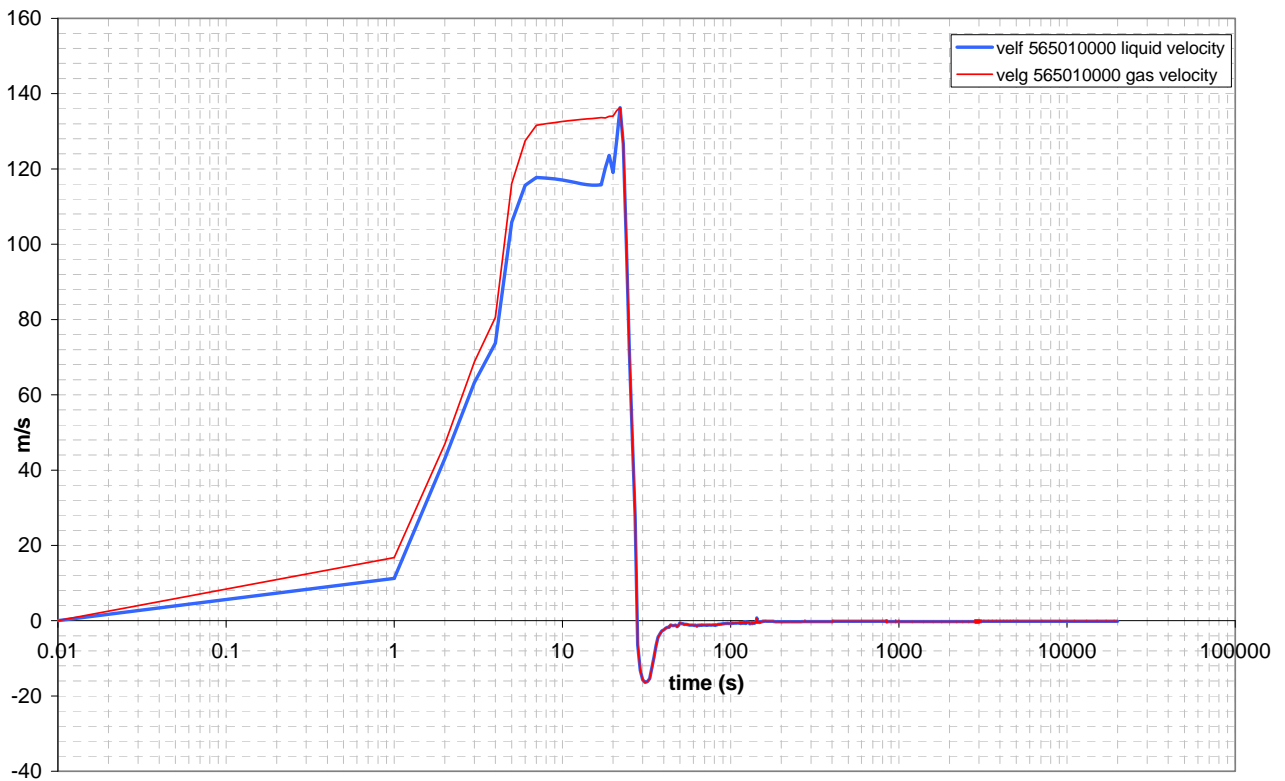

Figure 5.112: FL-B SPLIT BREAK LINE liquid and gas velocities UPSTREAM

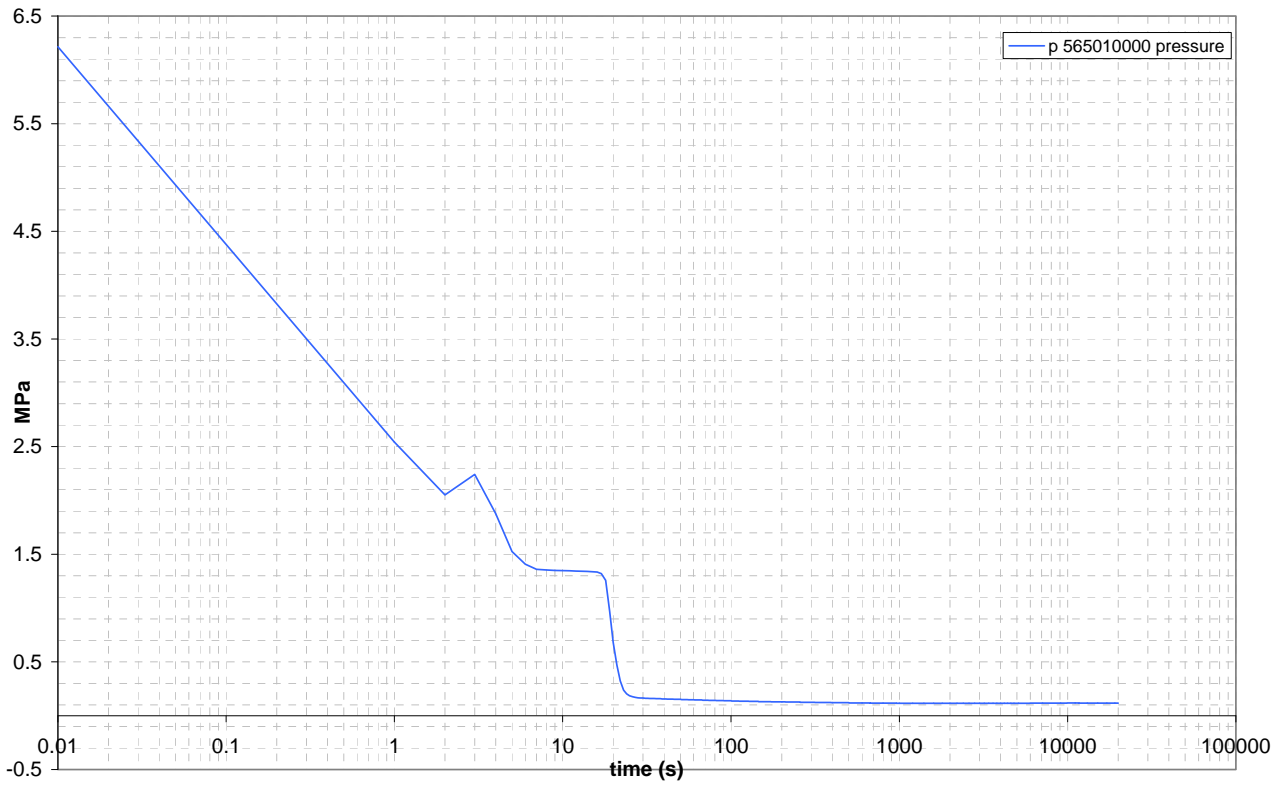

Figure 5.113: FL-B SPLIT BREAK LINE pressure UPSTREAM

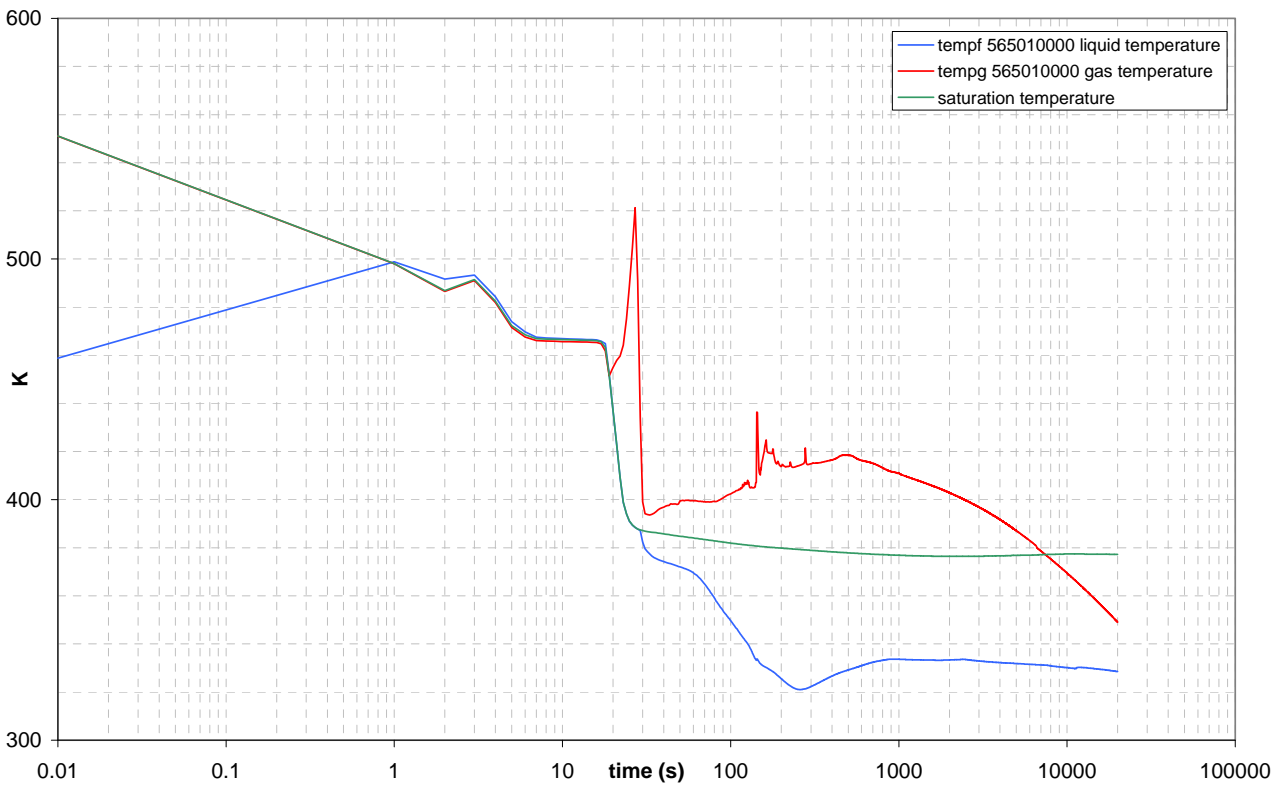

Figure 5.114: FL-B SPLIT BREAK LINE liquid and gas temperatures UPSTREAM

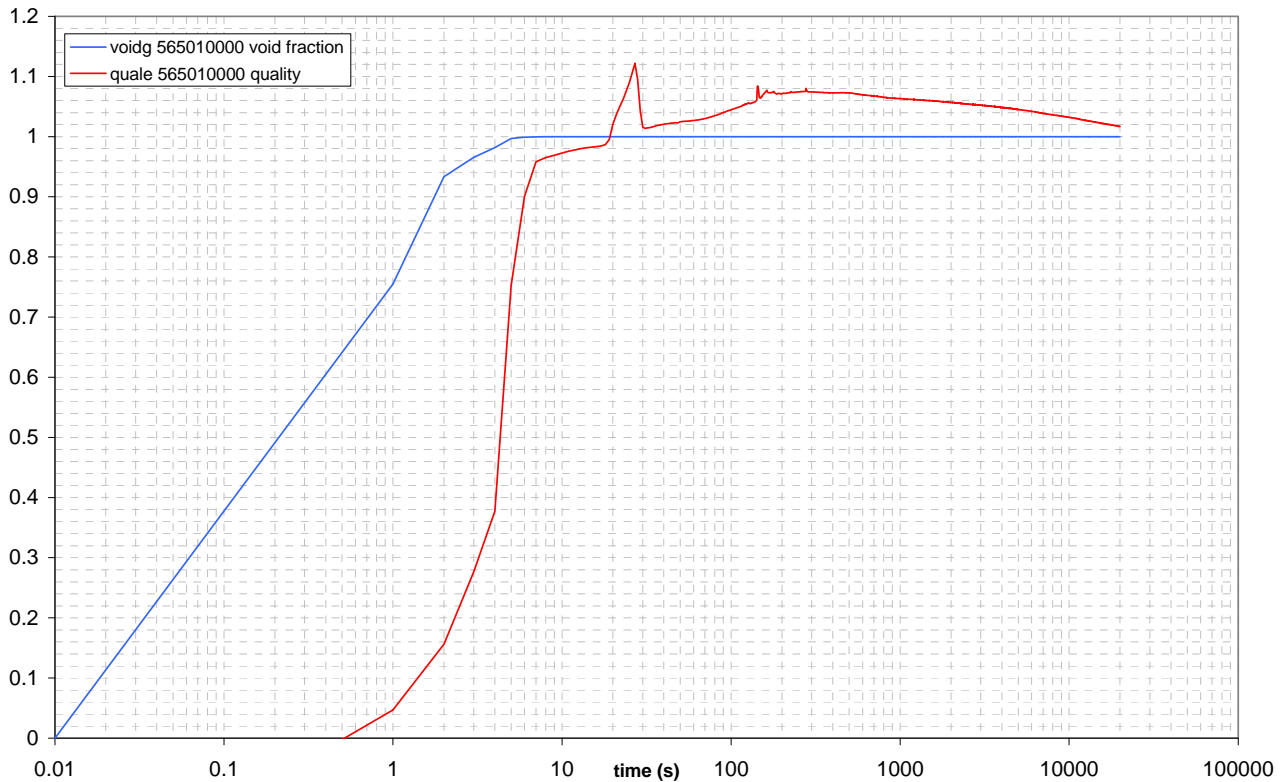

Figure 5.115: FL-B SPLIT BREAK LINE void fraction and quality UPSTREAM

Table 5.46: Maximum and minimum values of the main variables in the FL-B SPLIT break line upstream of the valve

FL-B SPLIT break line UPSTREAM		MIN	MAX
void fraction		0.0000	1.0000
volume equilibrium quality		-0.2799	1.1217
mass flowrate	kg/s	-0.0192	3.7740
liquid velocity	m/s	-16.3977	136.2470
gas velocity	m/s	-16.3977	136.2470
liquid temperature	K	321.0650	498.7680
gas temperature	K	393.0600	551.0490
pressure	MPa	0.1137	6.2157

The Table 5.46 shows the minimum and maximum values of void fraction, quality, mass flowrate, liquid and gas velocities, liquid and gas temperatures, pressure during the transient, upstream of the break.

DOWNSTREAM

The Figure 5.116, Figure 5.117, Figure 5.118 and Figure 5.119 represent the liquid and gas velocities, the pressure, the liquid and gas temperatures, the void fraction and the quality of the volume 567080000, downstream the break in the FL-B SPLIT line, Figure 4.10. Figure 5.120 shows the volumetric flowrate calculated using the area of the pipe, the void fraction, the gas and liquid velocities.

The mass flowrate is not shown because it is the same downstream and upstream of the break.

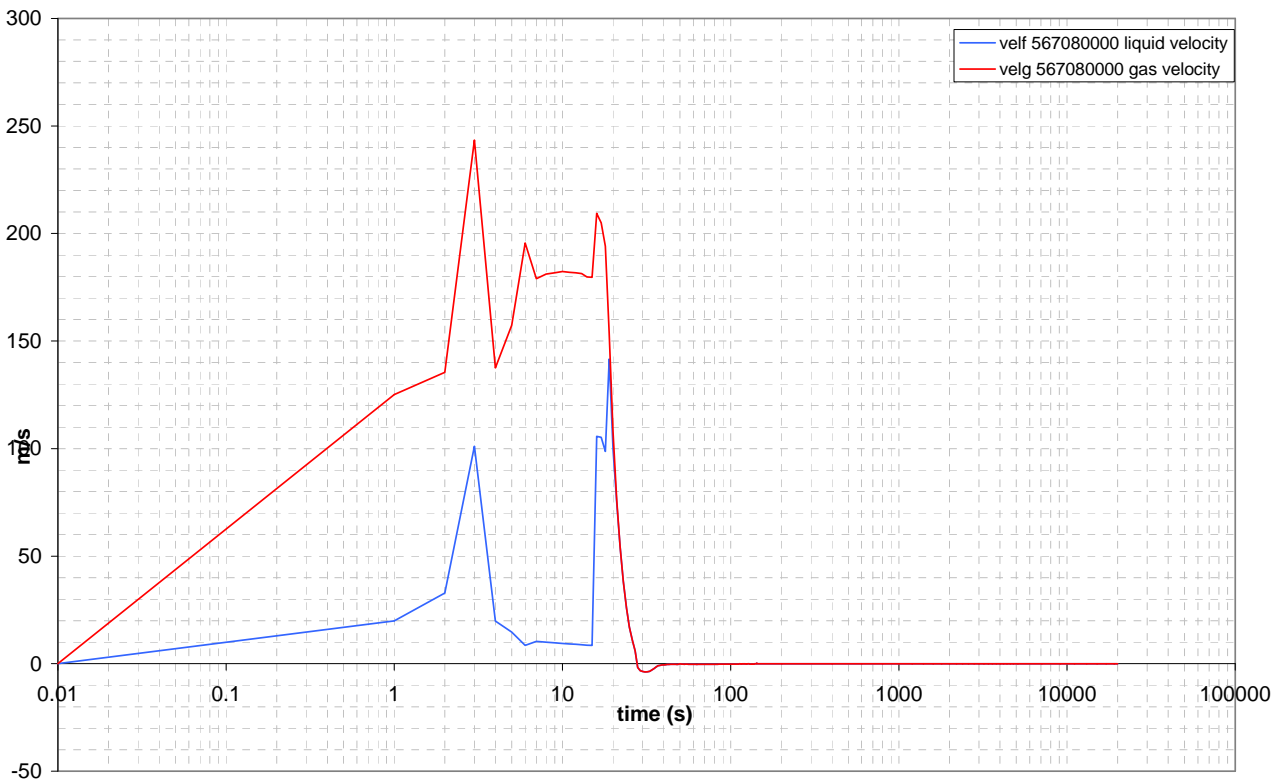

Figure 5.116: FL-B SPLIT BREAK LINE liquid and gas velocities DOWNSTREAM

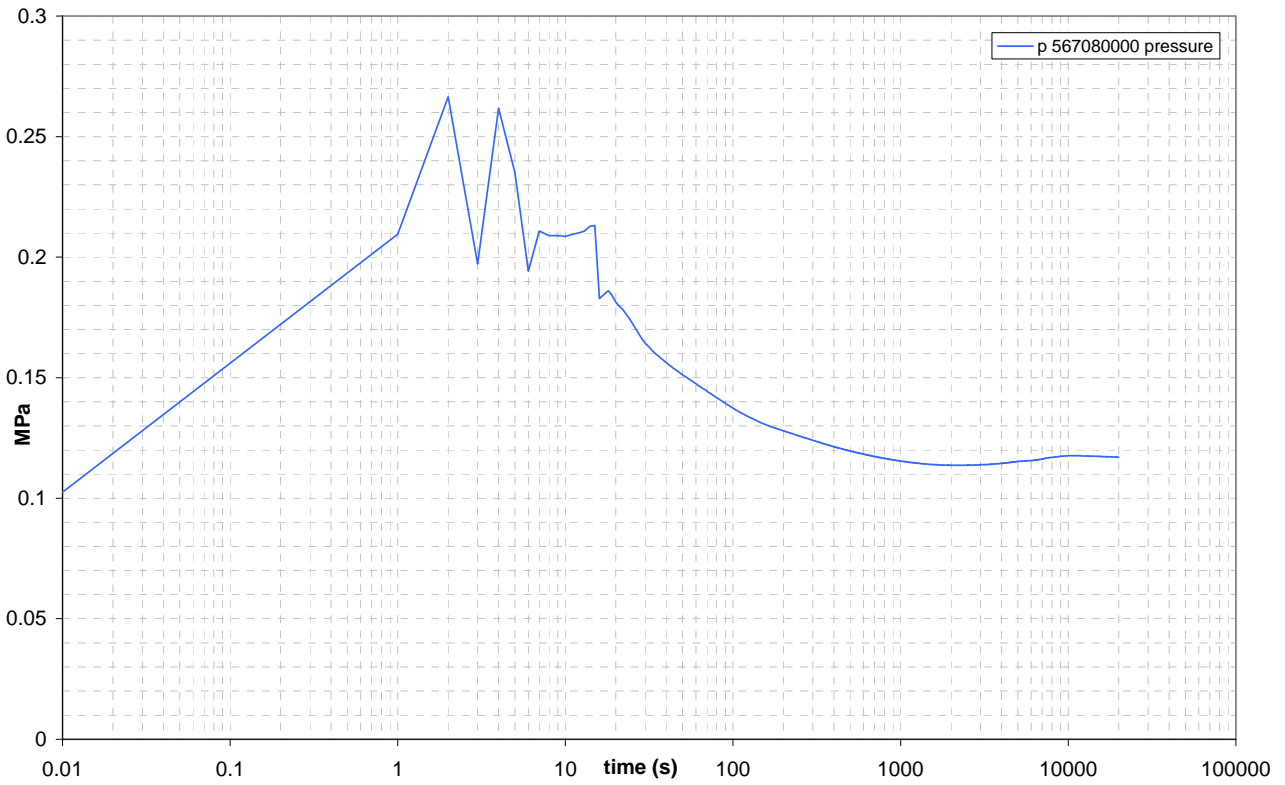

Figure 5.117: FL-B SPLIT BREAK LINE pressure DOWNSTREAM

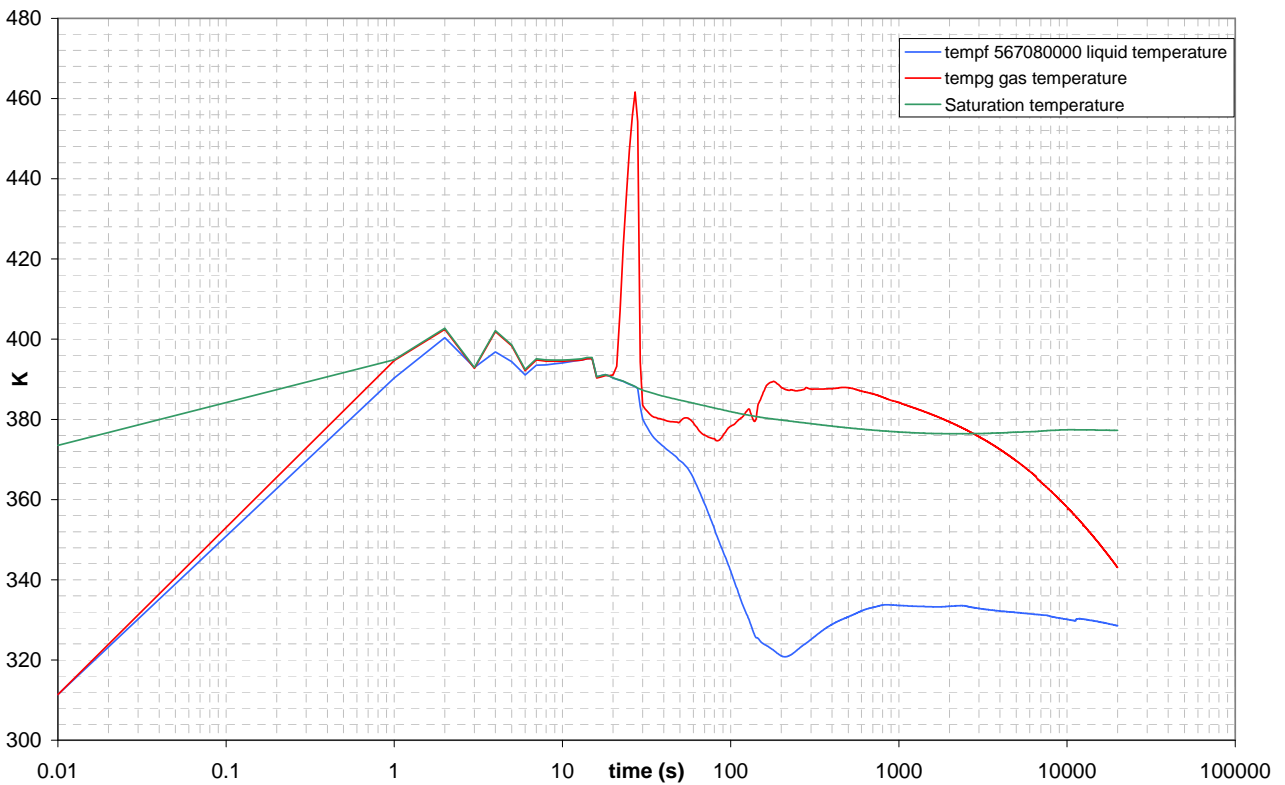

Figure 5.118: FL-B SPLIT BREAK LINE liquid and gas temperatures DOWNSTREAM

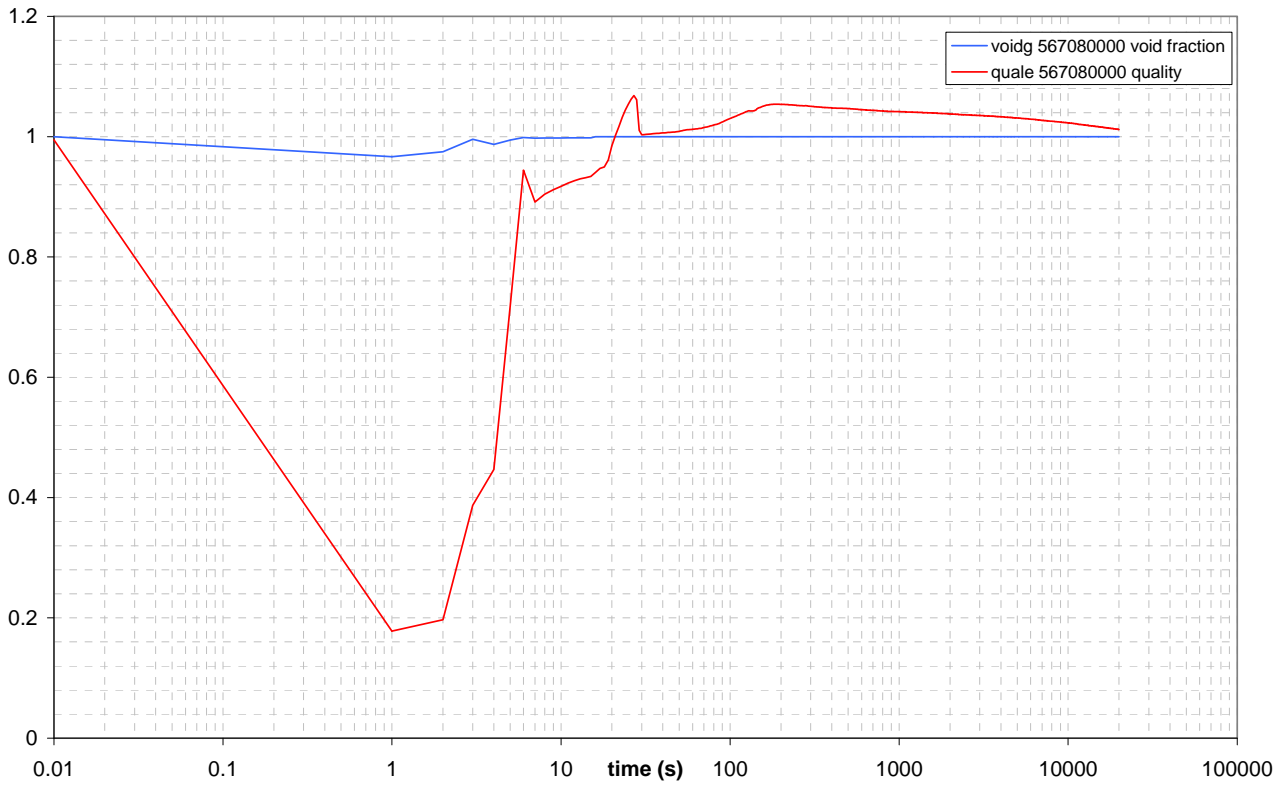

Figure 5.119: FL-B SPLIT BREAK LINE void fraction and quality DOWNSTREAM

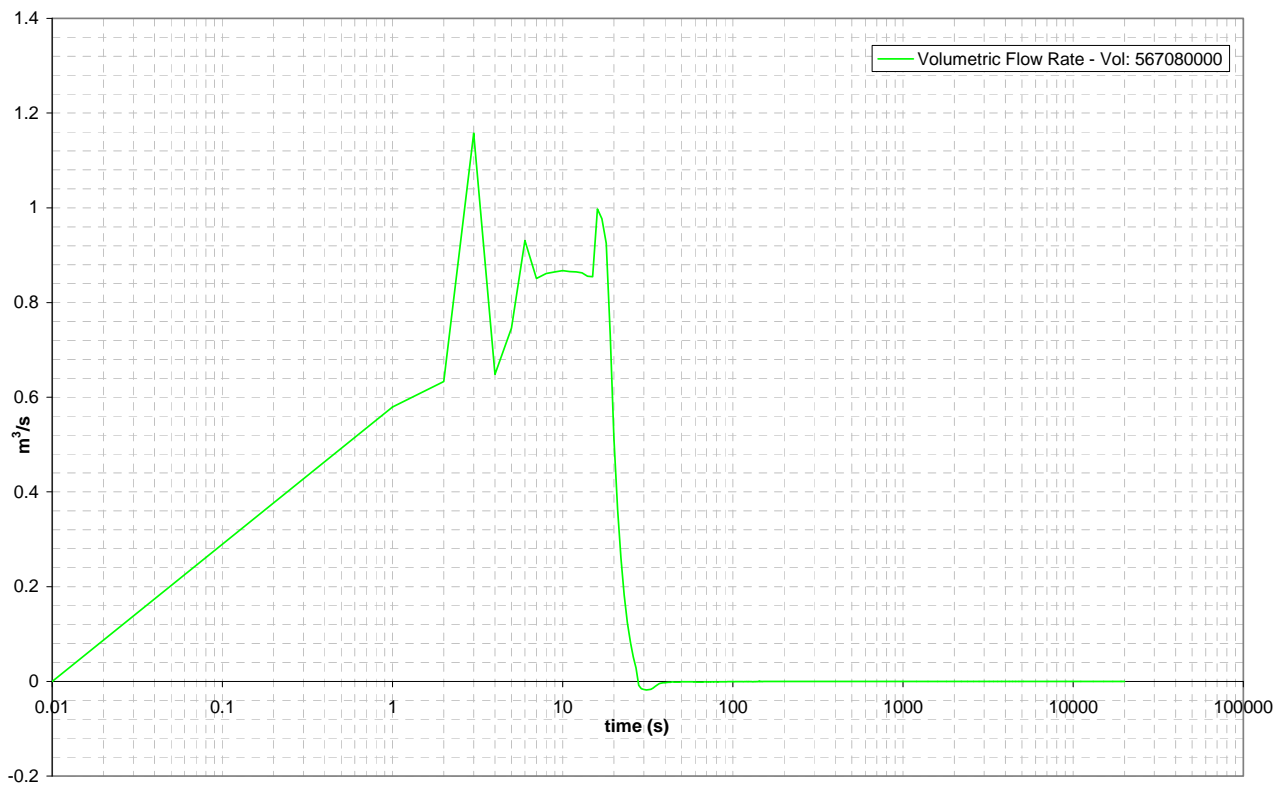

Figure 5.120: FL-B SPLIT BREAK LINE volumetric flowrate DOWNSTREAM

The

Table 5.47 shows the minimum and maximum values of void fraction, quality, mass flowrate, liquid and gas velocities, liquid and gas temperatures, pressure and volumetric flowrate during the transient, downstream the break.

Table 5.47: Maximum and minimum values of the main variables in the
FL-B SPLIT break line downstream of the break

FL SPLIT break line DOWNSTREAM		MIN	MAX
void fraction		0.9666	1
volume equilibrium quality		0.178	1.068
mass flowrate	kg/s	-0.019	3.774
liquid velocity	m/s	-3.780	141.655
gas velocity	m/s	-3.780	243.446
liquid temperature	K	320.80	400.38
gas temperature	K	343.05	461.63
pressure	MPa	0.1026	0.2664
volumetric flowrate	m ³ /s	-0.018	1.157

The Table 5.48 describes the flow regimes in the volume before the break and in some volumes after the break. The time step changes only when there is a modification in the flow regime. The volumes emphasized by red indicate the monitoring points.

FLOW REGIME

Table 5.48: Flow regimes function of monitoring volumes and time – FL-B SPLIT LINE

Time	565010000	567010000	567080000	567110000	568010000
0	BBY	CHF MPR	HST	CHF MPR	CHF MPR
1	SLG	ANM	ANM	ANM	ANM
2	ANM	ANM	ANM	ANM	ANM
15	ANM	ANM	ANM	ANM	ANM
17	ANM	CHF MPR	ANM	ANM	ANM
18	CHF MPR	CHF MPR	ANM	ANM	ANM
20	CHF MPR	CHF MPR	CHF MPR	ANM	ANM
22	CHF MPR	CHF MPR	CHF MPR	CHF MPR	CHF MPR
23	CHF MPR	CHF MPR	CHF MPR	CHF MPR	HST
24	CHF MPR	CHF MPR	CHF MPR	HST	HST
19990	CHF MPR	CHF MPR	CHF MPR	CHF MPR	CHF MPR

5.5.2.1 Synthesis of achievements for the FL SPLIT break

As detailed in [4], the FL-B SPLIT line mass flow is limited to the early phases of the transient, due to suction of water contained in the SG-B tubes towards the break. As shown in Figure 5.111 and Table 5.46, the mass flowrate is appreciable only in the first 30 seconds. Moreover, the void fraction is high both upstream and downstream of the valve, during the whole transient, as shown in Figure 5.115 and Figure 5.119.

This avoids the need to install a spool piece on the FL-B SPLIT break line.

For the FL-B SPLIT break line, a Venturi meter will be installed upstream of the break.

5.5.3 ADS lines

The ADS intervention is not foreseen in the FL-B break transient.

6 INSTRUMENT ANALYTICAL CORRELATIONS AND PARAMETER RANGES

On the basis of the break transients analyzed and described in the previous sections of this document, a total of five spool-pieces will be utilized to measure two-phase flow in SPES3, in the positions as follows:

- DVI SPLIT line downstream of the break valve;
- EBT SPLIT line downstream of the break valve;
- ADS ST SPLIT line downstream of the break valve;
- ADS ST Stage-I downstream of the break valve;
- ADS DT Stage-I downstream of the break valve.

6.1 Mass flow correlations

For the measurement of the two-phase mass flowrate, the knowledge of some flow parameters is necessary.

The two-phase mass flowrate can be expressed as:

$$\dot{m} = A[\alpha\rho_G V_G + (1-\alpha)\rho_L V_L]$$

where

A is the cross section area of the line;

α is the void fraction defined as $\alpha = \frac{A_g}{A}$, where A_g is the area occupied by the gas phase;

ρ is the density;

V is the velocity ;

G, L are the subscripts to indicate the gas and liquid phase.

The evaluation of mass flow and heat transfer rate in two-phase condition in the SPES3 facility will be carried-out by the measurement of three basic parameters: fluid density, velocity and momentum as indicated in [6].

On the basis of the results of [5], the instruments potentially suitable to measure the above said quantities are summarized in Table 6.1.

Table 6.1: Two-phase parameters and measurement instruments

Parameter	Instrument
Density	Gamma-densitometer
	Wire Mesh Sensor
	Capacitive Wire
Momentum	Drag disk
	Drag plate
Fluid velocity	Turbine Flow Meter
	Capacitive Wire
	Electro Magnetic
	Jet Deflection Detector

6.2 Parameter ranges

Table 6.2, Table 6.3, Table 6.4, Table 6.5 and Table 6.6 show the main operative ranges at which the instruments will work in the SPES3 facility. Such tables report the minimum and maximum values of the main variables for the lines where special instrumentation is foreseen. Moreover, there is the description of the involved RELAP5 volumes, the calibrated orifices at the valves and the dimensions of the pipes.

A preliminary indication of the maximum and minimum outputs of the turbine meter and the drag disk is also reported as obtained by the analytical expressions for such instruments and the RELAP5 data.

The minimum and maximum values of parameters reported in the tables related to the ADS ST and DT Stage-I, envelope the results of the operating conditions during the DVI, EBT and ADS break tests. The main virtual outputs of the turbine meter and drag disk are reported too.

6.3 Spool piece instrument correlations

The spool-piece is basically arranged with three different instruments including: a turbine meter, for volumetric flow or velocity, a drag disk, for the momentum flux, and a void fraction detector, as a gammadensitometer, a conductive or inductive sensor for the chordal average density of the fluid.

The main characteristics of the spool piece instruments, for the two-phase mass flow measurement, are briefly described in the followings:

- **turbine meter:** it measures an average two-phase velocity. Some models are available for the interpretation of the meter signal in two-phase flow. The meter signal needs to be

coupled to the measurement of the average density of the mixture, in order to reconstruct the two-phase mass flowrate as:

$$\dot{m} = A \cdot \bar{\rho} \cdot V_T$$

Where

V_T is the turbine velocity;

$\bar{\rho}$ is the mixture density.

The two-phase density can be expressed as the weighted average of the single phase densities over the volume occupied by each phase:

$$\bar{\rho} = \alpha \rho_G + (1 - \alpha) \rho_L$$

There are three main models describing the turbine velocity: the Aya model [7], the Rouhani model [8] and the volumetric model [9]. According to these models, the turbine velocity can be estimated as

$$V_T = V_L \frac{\sqrt{\rho_L(1-\alpha)} + S\sqrt{\rho_G\alpha}}{\sqrt{\rho_L(1-\alpha)} + \sqrt{\rho_G\alpha}} \quad (\text{Aya model})$$

$$V_T = V_L \frac{\alpha \rho_G S^2 + (1-\alpha) \rho_L}{\alpha \rho_G S + (1-\alpha) \rho_L} \quad (\text{Rouhani model})$$

$$V_T = V_L (S\alpha + (1-\alpha)) \quad (\text{volumetric model})$$

where S represents the ratio between the gas velocity and the liquid velocity (slip ratio).

- **drag disk:** it measures the average momentum flux on the plate area. The meter signal needs to be coupled to the measurement of the flow average density or to the flow average velocity in order to reconstruct the mass flowrate as:

$$\dot{m} = A \cdot [\bar{\rho} \cdot (\rho V^2)]^{1/2}$$

$$\dot{m} = A \cdot \left[\frac{(\rho V^2)}{V_T} \right]$$

where ρV^2 is directly measured by the drag disk, while the other variables need to be provided by the instrument which the drag device is coupled to.

The average momentum flux can be analytically determined by:

$$(\rho V^2) = V_L^2 (\alpha \rho_G S^2 + (1-\alpha) \rho_L)$$

- **gamma densitometers:** it measures the two-phase density averaged on a portion of the pipe section, depending on the particular configuration and on the number of the beams, according to the relation:

$$\bar{\rho} = \alpha\rho_G + (1-\alpha)\rho_L$$

Different models can be used to relate the beam attenuation to the average density, depending on the assumed void distribution.

- **impedance probe:** it measures the two-phase density averaged on a chord. The measures are based on the electrical impedance between two electrodes placed across a portion of the cross section of the pipe. Different arrangements can be utilised. Usually two types of probes are used: Capacitive Wire to detect the mixture capacitance and Wire Mesh Sensor to detect the mixture conductance.

In particular, the Wire Mesh Sensor can provide an image of the two dimensional distribution of the phases in the pipe cross section. It gives therefore a value of the average void fraction, through which the two-phase density can be calculated. It also provides information about the flow regime inside the pipe.

Table 6.2: DVI SPLIT break line

Test line		Control volume		Pipe size		Pipe inner diameter			
Upstream		665010000		½" Sch. 80		13.8 mm			
Downstream		667090000		2" ½ Sch. 40		62.7 mm			
Break:		Valve junction		666000000					
		Valve		IV10					
		Orifice		4.28 mm					
Bi-directional flow		Yes							
Flow regimes		Annular mist, bubbly, horizontal stratified							
Fluid conditions:		Pressure [MPa]	Temp. [°C]	Mass Flow [kg/s]	Quality	Liquid Vel. [m/s]	Gas Vel. [m/s]	Void Fraction	Volumetric Flow [m³/s]
MIN.		0.102	37.51	-0.13	-0.0025	-5.398	-0.922	0**	-0.002
MAX.		0.690	164.42	1.33	0.9997	55.492	187.888	1	0.464
		Turbine							
Preliminary instrument outputs:		Aya model [m/s]	Rouhani Model [m/s]	Volumetric Model [m/s]	Drag Disk [Pa]				
MIN.		-2.3753	-5.4803	-0.6228	0				
MAX.		93.2437	109.8769	187.1914	59740				

** The void fraction reaches the minimum value of 0 just at the end of the transient, when the safety system starts to operate. For the measure of our interest the minimum void fraction is 0.6256.

Table 6.3: EBT SPLIT break line

Test line		Control volume	Pipe size		Pipe inner diameter				
Upstream		622010000	¾" Sch. 80		18.9 mm				
Downstream		644030000	1" ¼ Sch. 40		35.1 mm				
Break:		Valve junction	643000000						
		Valve	IV13						
		Orifice	8.73 mm						
Bi-directional flow		Yes							
Flow regimes		Annular mist, mist pre-CHF, horizontal stratified							
Fluid conditions:		Pressure [MPa]	Temp. [°C]	Mass Flow [kg/s]	Quality	Liquid Vel. [m/s]	Gas Vel. [m/s]	Void Fraction	Volumetric Flow [m³/s]
MIN.		0.1024	128.73	-0.020	0.199	-5.691	-5.928	0.978	-0.006
MAX.		1.391	203.96	4.67	1.04	189.771	258.755	1	0.250
Preliminary instrument outputs:		Turbine			Drag Disk [Pa]				
		Aya model [m/s]	Rouhani Model [m/s]	Volumetric Model [m/s]					
		MIN.	-5.924	-5.928	-5.928	0			
		MAX.	236.10	248.05	258.56	900796			

Table 6.4: ADS SPLIT break line

<u>Test line</u>		<u>Control volume</u>		<u>Pipe size</u>		<u>Pipe inner diameter</u>			
Upstream		157010000		1" ½ Sch. 80		38.1 mm			
Downstream		133040000		3" Sch. 40		77.9 mm			
Break:		Valve junction		158000000					
		Valve		IV19					
		Orifice		13.18 mm					
Bi-directional flow		Yes							
Flow regimes		Annular mist, mist pre-CHF, horizontal stratified							
<u>Fluid conditions:</u>		<u>Pressure</u> [MPa]	<u>Temp.</u> [°C]	<u>Mass Flow</u> [kg/s]	<u>Quality</u>	<u>Liquid Vel.</u> [m/s]	<u>Gas Vel.</u> [m/s]	<u>Void Fraction</u>	<u>Volumetric Flow</u> [m³/s]
MIN.		0.1024	90	-0.044	0.435	-2.928	-2.928	0.993	-0.014
MAX.		0.795	216	4.51	1.076	205.687	405.115	1	1.930
		Turbine							
Preliminary instrument outputs:		Aya model [m/s]	Rouhani Model [m/s]	Volumetric Model [m/s]	Drag Disk [Pa]				
MIN.		-2.928	-2.928	-2.928	0				
MAX.		330.528	374.517	405.005	259194				

Table 6.5: ADS ST Stage-I line

Test line		Control volume	Pipe size		Pipe inner diameter			
Upstream		152030000	1" ½ Sch. 80		38.1 mm			
Downstream		134010000	1"½ Sch. 40		40.9 mm			
Break:		Valve junction	153000000					
		Valve	IV17					
		Orifice	13.18 mm					
Bi-directional flow		Yes						
Flow regimes		Annular mist, mist pre-CHF, horizontal stratified, bubbly						
Fluid conditions:	Pressure [MPa]	Temp. [°C]	Mass Flow [kg/s]	Quality	Liquid Vel. [m/s]	Gas Vel. [m/s]	Void Fraction	Volumetric Flow [m³/s]
MIN.	0.1024	36.8	-0.269	-0.0002	-2.9735	-2.9735	0**	-0.003
MAX.	2.0505	216.2	0.9577	1.0533	25.6128	66.3613	1	0.075
Preliminary instrument outputs:	Turbine			Drag Disk [Pa]				
	Aya model [m/s]	Rouhani Model [m/s]	Volumetric Model [m/s]					
	MIN.	-2.9734	-18.13		-2.9734	0		
MAX.	50.4865	59.818	65.5983	29724				

** The void fraction reaches the minimum value of 0 due to the reflux of water sucked from the quench tank. For the measure of our interest the minimum void fraction is 0.9471.

Table 6.6: ADS DT Stage-I line

Test line		Control volume	Pipe size		Pipe inner diameter			
Upstream		142080000	2" ½ Sch. 80		59.0 mm			
Downstream		1310100000	2"½ Sch. 40		62.7 mm			
Break:		Valve junction	143000000					
		Valve	IV15					
		Orifice	18.64 mm					
Bi-directional flow		Yes						
Flow regimes		Annular mist, mist pre-CHF, horizontal stratified						
Fluid conditions:	Pressure [MPa]	Temp. [°C]	Mass Flow [kg/s]	Quality	Liquid Vel. [m/s]	Gas Vel. [m/s]	Void Fraction	Volumetric Flow [m³/s]
MIN.	0.1024	38.2	-0.016	0.3281	-2.4829	-2.4829	0.94893	-0.008
MAX.	1.8419	216	3.1324	1.0695	32.8595	96.2626	1	0.261
Preliminary instrument outputs:	Turbine			Drag Disk [Pa]				
	Aya model [m/s]	Rouhani Model [m/s]	Volumetric Model [m/s]					
	MIN.	-2.4828	-2.4828		0			
	MAX.	55.1215	77.1020		36749			

7 CONCLUSIONS

In the frame of the SPES3 facility design for the IRIS reactor simulation, the need to measure two-phase mass flows has led to investigate flow characteristics and flow regimes in those pipes where transfer of fluids from the high pressure circuits (primary and secondary loops) to the low pressure one (containment) occurs.

The RELAP5 model of the SPES3 facility and the simulation of SBLOCA and secondary side breaks have allowed to investigate the transient trend of the main parameters that need to be measured in the test facility.

On the basis of the kind of transient and the foreseen mass flow, void fraction and phase velocities, five pipes have been selected for special instrumentation installation: DVI SPLIT line, EBT SPLIT line, ADS ST SPLIT line, ADS ST Stage-I, and ADS DT Stage-I. The envelope of values coming out of the analyses of the transients has allowed to define the ranges of values (pressure, temperature, mass flow, quality, slip ratio and void fraction) necessary to define the technical specification for the instrument forming the spool piece.

A spool piece, consisting on a turbine meter, a drag disk and a void fraction detector, might be installed on each of the above lines, downstream of the break or ADS valves.

The governing equations for each of these instruments have been briefly reported.

Two future steps of the activity are foreseen:

- starting from the instrument equations, develop a mathematical model suitable to provide the required quantities and to identify the best estimation method of data reduction. The model will be tested versus reference RELAP5 results;
- contact the instrument manufactures to verify the availability on the market of the specified instruments.

A further step should concern an experimental activity, propedeutic to the SPES3 test program to test and calibrate the spool piece, in particular: a) at cold conditions, with water-air mixture, in a facility suitable to modulate and show the fluid flow patterns; b) at hot conditions, with two-phase water, even with a reduced scaling factor, to test the data reduction correlations; c) at the SPES3 operative conditions to verify the spool piece performance.

8 REFERENCES

- [1] G. D. Storrck: IRIS integral system test specification. Westinghouse Electric Company STD-AR-08-01 Rev.1, November 2008.
- [2] SIET document 01 334 RT 07 Rev.1: Conceptual design of SPES3-IRIS facility Rev.1, September 2008.
- [3] SIET document 01 423 RT 08 Rev.0: SPES3-IRIS facility nodalization for RELAP5 Mod.3.3 code and steady state qualification, January 2009.
- [4] SIET document 01 489 RT 09 Rev.0: SPES3-IRIS facility RELAP5 base case transient analyses for design support, April 2009.
- [5] C. Bertani, N. De Salve, M. Malandrone, A.M. Masetto, B. Panella: Analysis of the two-phase flow meters and densitometers with the reference to the SPES-3 facility. CIRTEN – P9LU-002.
- [6] M. Furrer: Strumentazione, metodi e analisi impiegati per la misura della portata in massa in regime bifase. Enea. Maggio 1986.
- [7] Izuo Aya: A Model to Calculate Mass Flowrate and Other Quantities of Two-Phase Flow in a Pipe with a Densitometer, a Drag Disk, and a Turbine Meter. ORNL/TM-4759 November 1975.
- [8] S. Z. Rouhani: Application of the Turbine Type Flowmeters in the Measurements of Steam Quality and Void. Symposium of in-core Instrumentation, Oslo, Norway, June 1974.
- [9] K. G. Turnage, C. E. Davis: Advanced spool piece development, Presented at the 7th Water Reactor Safety Research Information Meeting, Gaithersburg, Maryland, November 1979.