



Agenzia Nazionale per le Nuove Tecnologie,  
l'Energia e lo Sviluppo Economico Sostenibile



*Ministero dello Sviluppo Economico*

## RICERCA DI SISTEMA ELETTRICO

*CERSE-POLIMI RL 1132/2010*

### Follow-up del programma sperimentale SPES3

*D. Paini, M.E. Ricotti*



FOLLOW-UP DEL PROGRAMMA SPERIMENTALE SPES3

D. Papini, M.E. Ricotti

Settembre 2010

Report di Ricerca Sistema Elettrico

Accordo di Programma Ministero dello Sviluppo Economico – ENEA

Area: Produzione e fonti energetiche

Tema: Nuovo Nucleare da Fissione

Responsabile Tema: Stefano Monti, ENEA

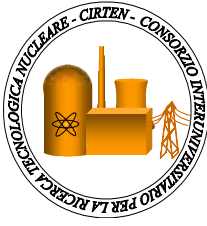

**CIRTEN**  
**CONSORZIO INTERUNIVERSITARIO**  
**PER LA RICERCA TECNOLOGICA NUCLEARE**

**POLITECNICO DI MILANO**

**DIPARTIMENTO DI ENERGIA, SEZIONE INGEGNERIA NUCLEARE - CeSNEF**

## **Follow-up del programma sperimentale SPES3**

**CIRTEN-POLIMI RL 1132/2010**

**AUTORI**

**D. Papini, M. E. Ricotti**

**Milano, Agosto 2010**

Lavoro svolto in esecuzione della linea progettuale LP2 punto B2 - AdP ENEA MSE del 21/06/07  
Tema 5.2.5.8 – “Nuovo Nucleare da Fissione”.



**INDEX**

**EXECUTIVE SUMMARY** ..... - 3 -

**1 INTRODUCTORY BACKGROUND** ..... - 5 -

**2 MODELLING OF CONDENSATION PHENOMENA WITHIN CONTAINMENTS** ..... - 8 -

**3 NODALIZATIONS OF THE IRIS DRYWELL**..... - 11 -

    3.1 RELAP5 nodalization ..... - 13 -

    3.2 GOTHIC nodalization ..... - 14 -

**4 RESULTS AND DISCUSSION** ..... - 16 -

    4.1 Preliminary comparison between GOTHIC and RELAP5 models ..... - 16 -

    4.2 Presence of droplets in GOTHIC break flow ..... - 19 -

    4.3 More realistic containment model developed with GOTHIC code ..... - 20 -

**5 CONCLUSIONS**..... - 22 -

**ACRONYMS** ..... - 24 -

**NOMENCLATURE** ..... - 25 -

**REFERENCES**..... - 26 -

*ANNEX I – IRIS CONFERENCE CALL MINUTES* ..... - 29 -

*ANNEX II – MODIFICATION OF RELAP5 WITH REVISED CONDENSATION CORRELATIONS*..... - 39 -



## EXECUTIVE SUMMARY

*This document presents the main contribution made in the last two years by Politecnico di Milano (Department of Energy, Nuclear Engineering Division) to the pre-licensing activities of the Generation III+ nuclear reactor concept IRIS (International Reactor Innovative and Secure). IRIS is an advanced integral pressurized water reactor, developed by an international consortium led by Westinghouse. The licensing process requires the execution of integral and separate effect tests on a properly scaled reactor simulator for reactor concept, safety system verification, and code assessment. Within the framework of an Italian R&D program on Nuclear Fission, managed by ENEA and supported by the Ministry of Economic Development, the SPES3 facility is under design and will be built and operated at SIET laboratories. SPES3 simulates the primary, secondary, and containment systems of IRIS with 1 : 100 volume scale, full elevation, and prototypical thermal-hydraulic conditions. The simulation of the facility with the RELAP5 code and the execution of the tests will provide a reliable tool for data extrapolation and safety analyses of the final IRIS design.*

*Several distortions appeared indeed in the first months of 2009 in the first scaling analyses comparing IRIS reactor response to a Small Break Loss Of Coolant Accident (SBLOCA), with that of its integral test facility SPES3.*

*Three break positions and related scenarios have been envisaged to confirm the capability of IRIS plant in mitigating the consequences of a SBLOCA event, in particular thanks to the possibility of maintaining reactor coolant system inventory without the necessity of high and low pressure injection systems. Among these breaks, DVI line break has been selected for initial analysis due to its potential to maximise water inventory depletion. This break represents a system lower break, leading to release of coolant to the Reactor Cavity (RC).*

*Simulations of the mentioned break have been performed with the RELAP5/GOTHIC coupled model developed by University of Zagreb as relates IRIS plant, and with the RELAP5 integral model developed by SIET as SPES3 facility is concerned. The results were at first not promising, pointing out a noticeable difference in the prediction of the system response to the selected accidental sequence. The dominant issue identified by scaling analysis was that the 10 : 1 SPES3 : IRIS scaling of the containment drywell area/volume ratio caused too much heat transfer between drywell atmosphere and vessel. This mainly increased condensation phenomena within the facility containment at the beginning of the transient, reducing and delaying SPES3 containment pressure peak during blowdown phase. Moreover, no superheated steam was produced in SPES3 before pressure equalization, whereas a significant amount characterized the IRIS response. As a consequence, problems arose in the proper dealing with specific scaling terms [1]. It is clear that differences in the heat structure models between IRIS and SPES3 are present, and containment response is of course sensitive to heat structures.*

*In this framework, different recommendations were proposed in order to understand the effective reason of the revealed discrepancy. A concern dealt with the condensation models implemented in GOTHIC code (used in the coupling provided by University of Zagreb to simulate containment response to mass and energy releases from reactor vessel) and in RELAP5 code (used by SIET for the integral nodalization of the facility): different correlations to study the condensation of the released steam could in fact justify the different pressure responses noticed.*

*Scope of the developed work – thoroughly presented in this document – was thus to provide an accurate comparison between various containment models, in order to quantify the capability of GOTHIC and RELAP5 codes in predicting*



*the same phenomenon, focusing the analysis on the heat transfer correlation point of view. A simplified realistic model of IRIS drywell has been developed both in GOTHIC and in RELAP5, reconstructing temperature and pressure transient in response to the same boundary conditions (mass and energy terms calculated for the Lower Break by complete IRIS RELAP5/GOTHIC model) and with the same amount of heat structures (in IRIS conditions). Just the initial part of the transient (the first 1000 s after the break) has been simulated. The primary objective was to develop with GOTHIC a more accurate containment model, able to match RELAP5 predictions according to the modelling approach followed by SIET, and thus to exclude the containment model with different codes as a possible reason for the different results between IRIS and SPES3.*

*A brief summary of the main thermal-hydraulic issues concerning steam condensation on the containment wall, as well as the different approaches available in literature for its modelling, is provided at the beginning of the report (Section 2). Comparison between the different correlations and heat transfer models implemented in the two codes is discussed; a particular significance is given to Uchida correlation, a semi-empirical correlation widely used for containment applications, which has been selected as preferred one for GOTHIC containment heat structures.*

*The different stand-alone models developed with GOTHIC and RELAP5 codes for this study are then presented (Section 3). To keep into account recirculation phenomena related to the large dimensions of the drywell, the approach chosen in RELAP5 is a slice-approach, based on two parallel pipes connected by transversal single junctions. GOTHIC model was built gradually, moving from a lumped volume drywell to a subdivided volume approach, to better catch flow and temperature distributions within the containment. A further step, from concentrated heat structures (connected just to drywell upper volumes) to distributed heat structures (surrounding all the drywell), was finally taken into account.*

*Several sensitivity studies regarding condensation heat transfer options and control volumes and heat structures modelling are proposed (Section 4). The most accurate containment model (in accordance with RELAP5 approach predictions) is described at the end of the report.*

*The work was conceived thanks to a deep collaboration with Prof. Davor Grgić of the University of Zagreb (FER – Faculty of Electrical Engineering and Computing), and represents a valuable contribution to the technical literature on thermal-hydraulic calculations in large volumes by means of transient analysis numerical codes. The results have been firstly presented at the International Conference "Nuclear Energy for New Europe 2009" (Bled, Slovenia, September 14-17) [2], and then published on the International Journal "Nuclear Engineering and Design" [3].*



## 1 INTRODUCTORY BACKGROUND

Nuclear safety has been one of the major issues to be studied since the inception of the nuclear industry. Establishing and maintaining core cooling and ensuring containment integrity are the two main goals that nuclear safety must guarantee.

Since the early 90s the advanced nuclear reactor designs have incorporated new safety features, mainly based on water gravity feed to the system or steam condensation under different conditions and geometries, to remove heat from the primary system or the containment atmosphere in case of a postulated accident. The improvement in these safety systems generally involved the development of suitable Passive Containment Cooling Systems (PCCSs). The diversity of the PCCSs has been illustrated by the General Electric's SBWR [4], where forced flow in-tube condensation takes place, and by the Westinghouse's AP600 [5], where condensation on externally cooled metallic surfaces occurs under free convection. The latter passive safety system, providing the safety-related ultimate sink for the plant so that containment pressure and temperature design limits are not exceeded, is similarly conceived for the AP600 power uprated version, the Westinghouse's AP1000 [6]. This unique concept, thoroughly described by [7], relies on the condensation of the steam (coming from water flashing in the event of a postulated accident where high pressure cooling water escapes into the containment) on the steel containment vessel walls. Steam condensation process, enhanced by the turbulent natural convection inside the containment but inhibited by a non-condensable gas layer formed adjacent to the wall, should provide sufficient cooling to keep the ambient conditions within containment under safe structural limits.

The IRIS reactor [8] is based on the major advanced engineering solutions of the latest LWR technology, as the passive feature given by the containment behaviour under accidental events mentioned above. The main difference of IRIS containment potential condensing conditions with respect to AP600/1000 designs will be addressed subsequently.

IRIS is a small-medium size (1000 MW<sub>th</sub>) pressurized water reactor with an integral configuration, suitable for modular deployment. The Reactor Vessel (RV) hosts all the primary system components: core, pressurizer, spool-type reactor coolant pumps, steam generators and control rod drive mechanism. The integral layout permits to fulfil the so named "safety-by-design" approach, that means trying to eliminate accidents initiators, or, if not possible, trying to limit their consequence and/or their probability of occurring. The lack of large primary penetrations in RV or large loop piping eliminates by-design the possibility of large releases of primary coolant (Large Break LOCA accidents). A novel approach in the plant response to a Small Break LOCA event is implemented thanks to the actuation of the Emergency Heat Removal System (EHRS), which is the main passive safety system of IRIS reactor (consisting of a closed-loop, two-phase flow, natural circulation system aimed to reject decay heat to the environment as a result of its removal via the steam generators) [9]. The consequences of SBLOCA events are limited by maintaining RV coolant inventory rather than injecting make-up water. With respect to the nominal mitigation sequence to a LOCA, based on water injection by active or passive devices (blowdown - refill - reflood phases) [10][11], IRIS response can be summarized as follows [12]:

- i. blowdown phase – the RV depressurizes and loses mass to the containment, until RV and containment pressure equalize;

- ii. depressurization phase – containment and vessel pressures are coupled and the coupled system is depressurized by the EHRS, without a further loss of mass from the core;
- iii. long-term cooling phase – core cooling is guaranteed by gravity driven flow of water into RV and by EHRS operation.

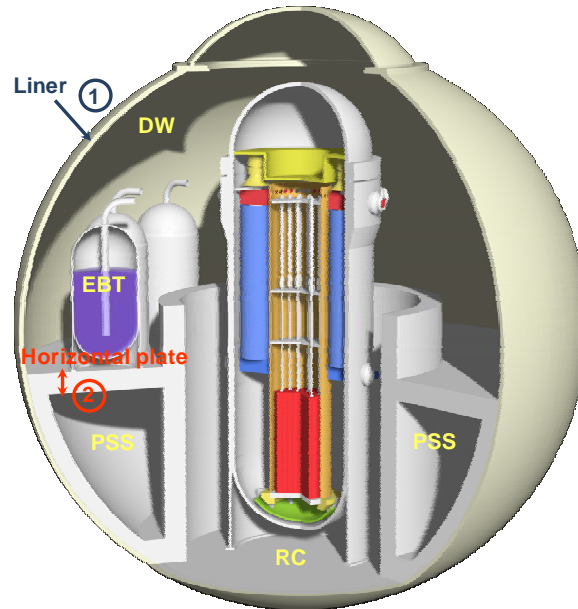

Figure 1 - Scheme of the IRIS containment, showing compartments and modelled heat structures.

The compact spherical steel containment is hence part of the IRIS safety approach, being directly involved, through a coupled dynamic behaviour, in the passive mitigation strategy that enhances the safety of IRIS. During the first part of the transient (blowdown phase), the simultaneous combination of pressure decrease inside RV with pressure increase in the containment quickly reduces the pressure difference across the break, stopping thus the loss of mass and permitting to maintain in vessel enough coolant inventory to cover the core. After the pressure equalization between RV and containment, the break flow rate reverses, following the unique IRIS approach of providing heat removal inside the reactor vessel and thus RV depressurization by the EHRS.

As shown in Figure 1, IRIS containment consists of different compartments, in particular the Dry-Well (DW), the Reactor Cavity (RC), and the Pressure Suppression Systems (PSSs). In addition, IRIS safety systems are shown in Figure 2. Except the EHRS, which is located in Auxiliary Building (AB), all of them are inside containment. An Automatic Depressurization System (ADS) dumps steam in a Quench Tank (QT) in case of need during transients and accidents. Long-term Gravity Make-up Systems (LGMSs) use tanks with water to refill the vessel after RV pressure decrease. Emergency Boration Tanks (EBTs) are connected to the Direct Vessel Injection (DVI) lines which inject water into the vessel from LGMS and eventually from RC. The EHRS heat exchangers are contained in the Refuelling Water Storage Tank (RWST) outside containment. PCCS is provided to intervene limiting the containment pressure only in case of EHRS unavailability. No external cooling is expected for IRIS containment walls (as it is, conversely, for the AP600/1000 containments by means of an air baffle and a water gravity discharge on the outside), hence the potential condensing conditions involve reduced temperature gradients across the containment walls (with a limited wall subcooling with respect to internal bulk atmosphere).

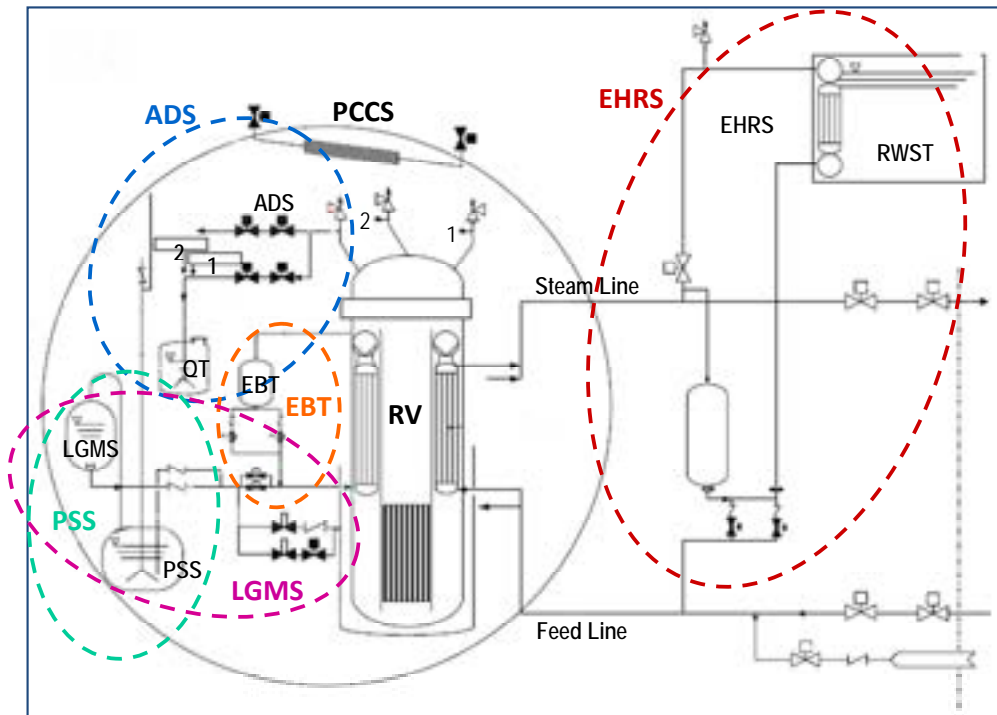

Figure 2 - IRIS safety systems [13].

In this framework, the demonstration of the IRIS reactor capability to successfully respond to the various initiating events (considered just SBLOCA accidents) requires a deep knowledge of all the thermal-hydraulic phenomena involved in each postulated sequence as well as the availability of appropriate computer tools, in position to accomplish an integrated approach analysis to the whole reactor system (including containment).

A preliminary study was performed [14] addressing the main design basis events for IRIS aimed to assist in the definition of requirements for IRIS evaluation models and the development of a complete set of Phenomena Identification and Ranking Tables (PIRTs) [15].

The present work is a contribution to the activities in progress in the frame of the transient analyses comparing IRIS plant response to DVI line break (selected due to its potential to maximise water inventory depletion) with that of its scaled integral test facility SPES3 [13], designed by SIET company to simulate the accidental sequences involving IRIS primary, secondary and containment systems. Simulations of the DVI-SBLOCA are being performed with the RELAP5/GOTHIC coupled model [16] developed by University of Zagreb as relates IRIS plant, and with the RELAP5 integral model [17] of the facility developed by SIET to support different stages of the SPES3 design.

Objective of this document is to discuss several containment models and to check the capability of the "pipe oriented" code RELAP5 [18] in large volume thermal-hydraulic calculations. RELAP5 Code Assessment Matrix, which comprehends SBLOCAs, LOCAs and transient analyses as well, does not include indeed applications to large dry containments, generally treated with dedicated code packages (e.g. GOTHIC - Generation Of Thermal-Hydraulic Information for Containments). The influences of the heat structure modelling and available heat transfer correlations have been stressed in the study. A simplified model of IRIS drywell has been developed both in GOTHIC and in RELAP5. Temperature and pressure transients have been assessed in response to the same boundary conditions (mass and energy terms calculated for the DVI break by complete IRIS RELAP5/GOTHIC model) and with the same amount



of heat structures (in IRIS conditions). When comparing results of IRIS calculations using coupled RELAP5/GOTHIC code and scaled SPES3 model calculations using RELAP5 code some differences were indeed found in variables being selected as representative for most important phenomena. The differences can be related to the limitations of performed scaling process (1 : 100 volume ratio and full elevations) and to the selected modelling and calculational capabilities of used computer codes. A key point of the work is to identify what is level of distortions possible between RELAP5 and GOTHIC results when modelling IRIS containment drywell, taking into account both, selected discretizations appropriate for each code and available HTC correlations. As a second goal, the most accurate GOTHIC containment modelling approach, to be used in realistic IRIS transient analyses, should be selected. To the aim, several physical model options and heat transfer correlations have been tested, estimating their impact on the system response.

This work is partly conceived also to answer certain interesting questions to how far can system codes like RELAP5 fit in addressing the classes of thermal-hydraulic phenomena involved within containment issues. Advanced LWR containment modelling with RELAP5 represents a topical research field for code validation, already dealt with by international experimental programs (e.g., the post-test analysis on OECD/NEA ISP-42 PANDA test) [19] and by internal computational benchmarks [20]. Testing of different code physical models and nodalization schemes were provided, producing acceptable results in calculation of typical containment problems at low pressure environments in the presence of large amounts of non-condensable [21]. To the best of our knowledge, nevertheless, careful modelling and significant user experience were required. As a result, no one tried to use that kind of models for reactor licensing applications. Besides, the work by Delnevo et al. [20], focused on the use of well known computer codes both for integrated (RV and containment) and containment stand-alone calculations of the IRIS response to a SBLOCA (selected CVCS line break), simplified the analysis without including thermal structures. That is, no heat transfer was assumed from the containment atmosphere to the containment structures and to the external environment.

Finally, it is just remarked that, in the frame of IRIS licensing application, RELAP5 is being applied to integral model of the experimental facility only, aimed at predicting the behaviour of the real IRIS model performed with coupled RELAP5/GOTHIC code (hence, IRIS drywell nodalization developed with RELAP5 is not intended to apply for the real plant).

## 2 MODELLING OF CONDENSATION PHENOMENA WITHIN CONTAINMENTS

Many efforts have been made over the last three decades to understand the phenomena governing the condensation of the steam on containment walls. The importance of the most influencing variables can be classified in the following three categories [22]:

- a. primary variables like non-condensable gas mass fraction, subcooling temperature difference and operating pressure;
- b. secondary variables like suction effect, mist formation and film waviness;
- c. tertiary variables like effect of the type of non-condensable light gas (nitrogen, argon or helium) and the condensing surface orientation.

Amongst all of them, the key parameter characterizing the condensation of the steam released within the containment atmosphere is composition and concentration of non-condensable gas. Large amounts of air (or nitrogen), present in normal operation conditions inside the reactor containment, create an additional thermal resistance and worsen

significantly the condensation process by reducing interface saturation temperature at steam partial pressure, hence the temperature difference with the wall which drives the process [23].

The studies aimed to a deeper understanding of the processes involved within the containment behaviour analysis have been divided in two main categories: experimental and theoretical investigations.

The pioneering experimental work in this field is due to Uchida et al. [24], who presented a semi-empirical heat transfer correlation dependent solely on the non-condensable gas mass fraction in the condensing steam, and validated on a full set of experimental data collected for condensation of steam with various non-condensable gases (nitrogen, air and argon) onto a vertical plate. In more recent years, several experimental programs have been carried out to address specific advanced reactor scenarios, particularly under the conditions of the SBWR [25][26][27] and of the AP600 [28][29].

Mechanistic condensation modelling has been traditionally addressed by two different approaches: solution of the conservation equations in the boundary layer [30][31][32] and the application of the heat/mass transfer analogy [33][34][35][36][37][38].

The latter methodology, which is simpler and more easily implementable than completely analytical approaches, is indicated in open literature as the preferable in containment accident analysis thanks to its capability to better reproduce the new condensation conditions showed by advanced LWRs. In all the available works, heat/mass transfer analogy is simply expressed as a heat transfer relationship, according to the sketch of Figure 3 in the form of [34]:

$$h_T = \frac{q_{bw}}{(T_b - T_w)} = \frac{h_{film}(h_{conv} + h_{cond})}{h_{film} + h_{conv} + h_{cond}} \quad (1)$$

in which the different heat transfer terms have to be treated separately, being:

- $h_{film}$  the heat transfer coefficient within liquid film on the wall;
- $h_{conv}$  the sensible heat transfer coefficient through gas-vapour boundary layer;
- $h_{cond}$  the condensation heat transfer coefficient through gas-vapour boundary layer, proper function of the condensation conductivity to evaluate the effective mass diffusion.

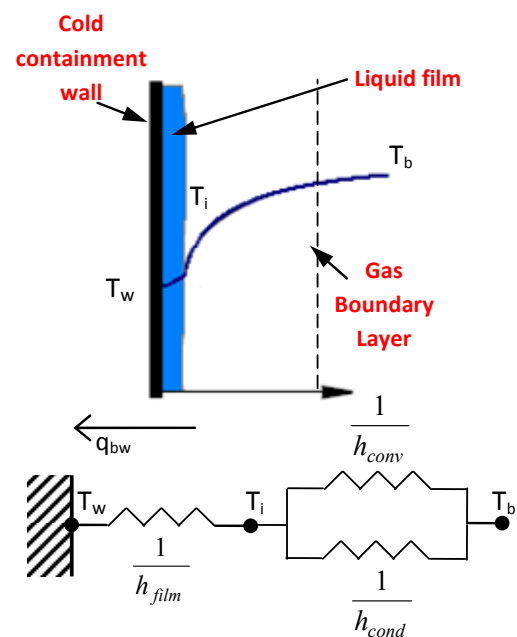

Figure 3 - Schematic diagram of condensation process on the containment wall, with equivalent heat transfer resistance circuit.

A thorough summary of the literature modelling of condensation conductivity is provided by Ganguli et al. [38]. Herranz et al. [36] showed in details how to include within the diffusion layer theory proposed by Peterson et al. [34] peculiar effects like suction, film waviness and mist formation that are encountered in case of strong temperature gradients across the wall (as it is proper for the externally cooled containments of AP600/1000). Indeed, all the analogy-



based models tend to underestimate experimental results without empirical correction factors to account for the mentioned effects, as recently confirmed by Ganguli et al. [38].

Considering moreover that IRIS containment could be externally cooled just in case of EHRS unavailability, it seemed more suitable to utilize in this study condensation correlations based on experimental data, like the Uchida correlation. According to the computational nature of the provided analyses, four direct condensation options are available in the heat transfer package of GOTHIC [39], which was the reference T/H code selected for the simulation of the first part of IRIS SBLOCA on DVI line:

- Uchida correlation;
- Gido-Koestel correlation;
- maximum of Uchida and Gido-Koestel correlations;
- modified Uchida correlation.

Gido-Koestel correlation [40] accounts for the effect of steam bulk velocity on the heat and mass transfer rates, missed by Uchida correlation, but it is not NRC approved due to its not conservative features. Hence, the Uchida has been the preferred one to be selected in the analyses. Extensively used in the nuclear industry to predict condensation rates inside containment structures, Uchida correlation is based on experimental data collected with a constant volume vessel initially filled with non-condensable gas at atmospheric pressure (101.325 kPa). Heat removal rates are instead significantly underpredicted for bulk gas pressure above 101.325 kPa (1 atm) and overpredicted for bulk gas pressure below 101.325 kPa (1 atm). Its validity is limited to the range 11.36 – 1578.48 W/m<sup>2</sup>K.

A comprehensive discussion on the validity of Uchida correlation is provided by Peterson [41], where a theoretical basis for the form of the equation (relating the total HTC just on the non-condensable gas mass fraction) is presented starting from Eq. (1). Uchida correlation can be derived in case that: (i) liquid film is thin, due to a relatively short height of the vertical surface ( $h_{\text{film}}$  tends to infinite); (ii) bulk mixture is close to saturation conditions (no superheated steam is condensed). A problem raising concern with the use of Uchida correlation deals with the case of gas bulk pressures below atmospheric pressure value (101.325 kPa), when the total HTC can be significantly overpredicted. Considered a BWR containment concept, the same adopted in IRIS, this can occur when noticeable quantities of non-condensable gas are relocated to the wetwell (PSS tanks), such that the non-condensable gas partial pressure is reduced significantly in the drywell volume where the primary wall condensation takes place. Containment response may be not conservatively predicted using hereby the Uchida correlation. It is worth noting that, however, this concern is tempered by the typical observation that Uchida correlation is conservative in predicting integral containment experiments, which can be attributed to the significant enhancement of natural convection under LOCA conditions by forced convection from high velocity steam jets [28].

Different formulations can be found in literature (as well as in GOTHIC heat transfer package) for the Uchida correlation. HTC can be expressed as a function of non-condensable gas mass fraction  $W$  [36], or else as a function of the ratio of non-condensable bulk density  $\rho_{gb}$  to vapour bulk density  $\rho_{vb}$  [41][39]. Both formulations, listed in Table 1, are equivalent, except for the numerical coefficient depending on the gas composition and on selected HTC units.

Figure 4 shows the comparison of the different formulations with Uchida experimental data (related to the three non-condensable gases nitrogen, air and argon), as rearranged by Peterson [41]. With the main purpose of an advice to GOTHIC users, it is noticed that GOTHIC Uchida selection, qualified for its utilization in the code, gives for lower gas to vapour density ratios slightly higher heat transfer coefficient values in comparison with literature formulations.

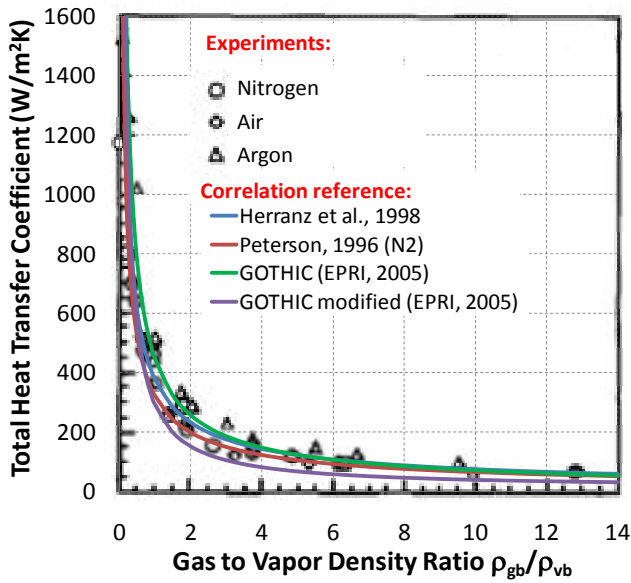

Figure 4 - Uchida experimental data, adapted from Peterson [41] and compared with the various relationships developed.

Table 1 - List of the various formulations of Uchida correlation for direct condensation of steam inside containment structures.

Reference	Uchida correlation HTC [W/(m <sup>2</sup> ·K)]
Herranz et al., 1998	$h_T = 380 \left( \frac{W}{1-W} \right)^{-0.7}$
Peterson, 1996 (N <sub>2</sub> )	$h_T = 323 \left( \frac{\rho_{gb}}{\rho_{vb}} \right)^{-0.7}$
GOTHIC (EPRI, 2005)	$h_T = 450.44 \left( \frac{\rho_{gb}}{\rho_{vb}} \right)^{-0.8}$
GOTHIC modified (EPRI, 2005)	$h_T = 11.36 + 283.90 \left( \frac{\rho_{gb}}{\rho_{vb}} \right)^{-1}$

Modified Uchida selection, which has not been applied yet in the qualification of GOTHIC, but has been already used in Japan for containment applications [39], proves to be more conservative and closer to the experimental data collected with nitrogen (gas present within the IRIS containment). Both the formulations have been taken into the proper account for the scopes of the document.

### 3 NODALIZATIONS OF THE IRIS DRYWELL

IRIS safety strategy in response to a SBLOCA event, as anticipated based on maintaining reactor coolant inventory rather than injecting make-up water, is accomplished thanks to its specific containment design. Pressure suppression capability is implemented hosting tanks with water (PSS tanks) and important safety features are provided with LGMS and ADS. Water inventory is kept in the core using combination of initial high containment backpressure, direct removal of the heat from the core and fast primary pressure decrease in the first phase of the transient, as well as direct heat removal from the core and addition of the water to the core from LGMS and from RC in the second phase of the transient. It is stressed that real modelling of IRIS containment is more complicated than presented model used to explore possible differences between the two codes applied to the calculation of the selected component.

Just the drywell region, as a largest volume in a calculational model, has been modelled within the containment. The goal of the simulation was to cover first 1000 s of the transient (blowdown phase), before pressure equalization and without ADS intervention. Postulated case is a 2" DVI line break (break area equal to 0.00203 m<sup>2</sup>), assumed as double ended guillotine rupture; hence, both sides of the break (RV side and DVI side) are considered as mass and energy source to the drywell. Investigated drywell model is uncoupled from the rest of the containment model (RC, PSS, LGMS tanks) and reactor vessel. The mass and energy releases from the reactor vessel, calculated by coupled RELAP5/GOTHIC IRIS model [16], are simply represented as proper boundary conditions at the connection between drywell and reactor cavity.

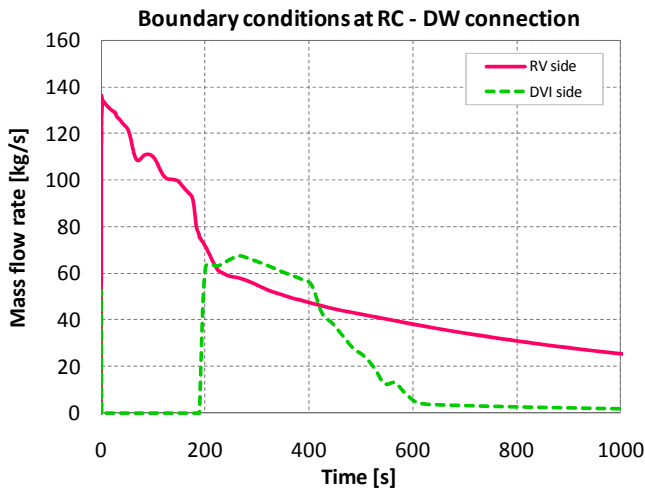

Figure 5 - Mass flow rates released to the drywell.

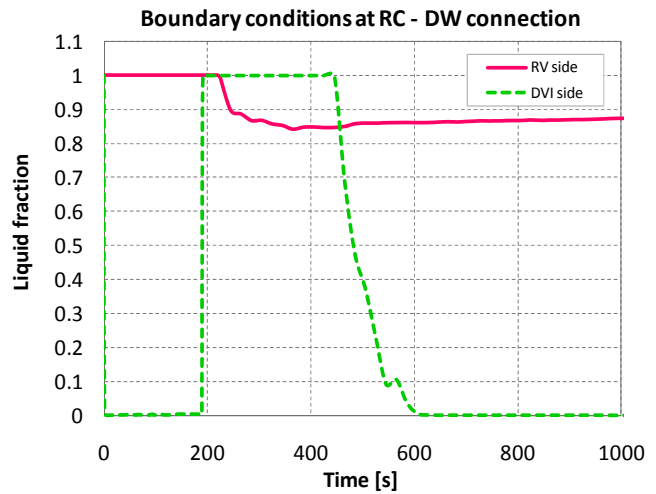

Figure 6 - Liquid fractions of the discharged fluid.

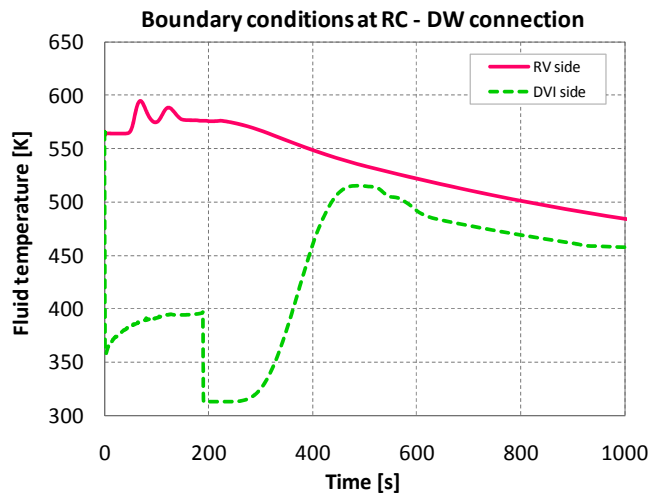

Figure 7 - Temperatures of the fluid entering the drywell.

The mass flow rates, liquid fractions and the temperatures of the discharged fluid are shown in Figure 5, Figure 6 and Figure 7 respectively. The fluid is mostly high pressure liquid (upstream pressure is around 12 MPa at 100 s and around 2 MPa at 1000 s). In full coupled model, the discharge is directed to the cavity and fluid entering from the reactor cavity to the bottom of the DW is steam.

For this analysis the spherical geometry of the containment is simplified with a rectangular shape drywell with approximate free volume, according to the geometrical data reported in Table 2. Two thermal structures are introduced to model the heat transfer from containment atmosphere to the containment wall and then to the external environment and from containment atmosphere to the operating deck concrete. The first heat structure is carbon steel liner wrapping the drywell, whereas the second heat structure is operating deck concrete dividing drywell volume from PSS tanks and rest of the containment, as clearly depicted in Figure 1. Liner thermal structure connects drywell volumes to the environment (AB building), modelling condensation and convection heat transfer within the drywell (internal side) and natural convection heat transfer towards the ambient (external side).

RELAP5 and GOTHIC codes have been used to build the described stand-alone model of the IRIS drywell, imposing the same boundary conditions and the same amount of heat structures. Two basic models have been respectively



developed, aimed at a quick but comprehensive comparison on how the two codes are capable of addressing large volumes in transient analysis. System response has been studied identifying suitable base parameters, which define proper criteria to quantify how a simple RELAP5 nodalization with 1D components could be applied to duly predict the thermal-hydraulics in large volumes, such as a reactor containment atmosphere under SBLOCA conditions.

Table 2 - IRIS preliminary containment data used in the analysis.

<b>Drywell</b>	
Volume [m <sup>3</sup> ]	3227
Height [m]	11.5
Hydraulic diameter [m]	13.4
Initial pressure [Pa]	$1.01325 \cdot 10^5$
Initial temperature [K]	322.05
Initial gas composition	100% N <sub>2</sub>
<b>Containment heat structures</b>	
<i>Liner (1)</i>	
Material	Carbon Steel
Thickness [m]	0.0445
Surface [m <sup>2</sup> ]	1005
Initial temperature [K]	322.05
<i>Horizontal plate (2)</i>	
Material	Concrete
Thickness [m]	0.30
Surface [m <sup>2</sup> ]	252
Initial temperature [K]	322.05
<b>Environment</b>	
Initial pressure [Pa]	$1.01325 \cdot 10^5$
Initial temperature [K]	308.15
Initial humidity [%]	60

### 3.1 RELAP5 nodalization

RELAP5/MOD3 is a transient analysis code for complex thermal-hydraulic systems. The fluid and energy flow paths are approximated by 1D stream tube and conduction models. The code is based on a non-homogeneous non-equilibrium set of 6 partial derivative balance equations for the steam and liquid phase. A non-condensable component in the steam phase and a non-volatile component (e.g. boron) in the liquid phase can be treated. A fast partially implicit numerical scheme is used to solve the equations inside control volumes connected by junctions. In addition, the code contains system component models for situations where "pipe oriented" approach does not apply or needs too much effort to develop (e.g. pumps, accumulators, separators). When required, the fission process can be described within point-

kinetics theory with thermal-hydraulic feedbacks; besides, models of protection and control system can be approximated using trips and control variables.

Notwithstanding, modelling of large components with the RELAP5 code is not an easy task. A sliced approach is used in order to better address atmosphere natural circulation flows. This approach is presented in Figure 8, where the developed nodalization is shown.

Drywell is simulated with two parallel pipes (400 and 401) subdivided in 12 volumes and connected by transversal single junctions. Heat structures representing carbon steel liner (400-1, 401-1), each for the competing portion of drywell pipes, are thermally coupled to the common environment, simulated with third RELAP5 pipe component (403). Heat structures representing concrete horizontal plate (400-2, 401-2) are connected from both sides (left and right bound) to the first volume of the two pipes. Break terms are employed as boundary conditions, by means of time-dependent junctions and time-dependent volumes as regard mass flow rates and break enthalpies (internal energies) respectively.

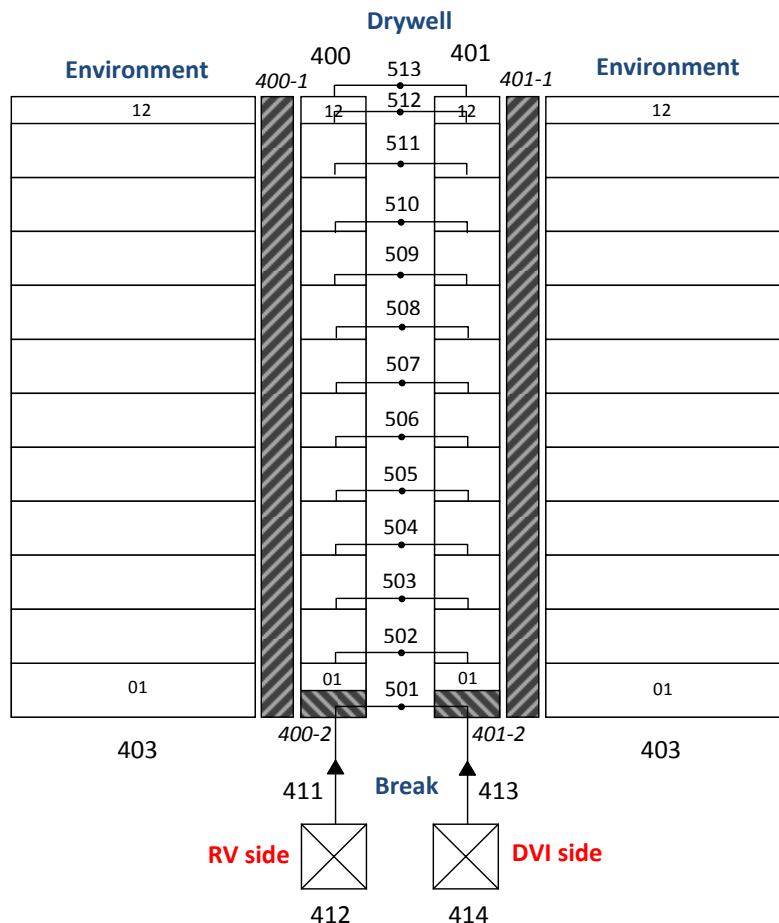

Figure 8 - RELAP5 nodalization for the stand-alone model of IRIS containment drywell.

### 3.2 GOTHIC nodalization

GOTHIC is a CFD-like code that predicts compartment thermal-hydraulic behaviour using conservation of mass, momentum, and energy equations for multiphase (vapour phase, continuous liquid phase, droplet phase)

multicomponent (water, air, H<sub>2</sub>, noble gases) compressible flow. Phases can be in thermodynamic equilibrium or constitutive relations can be used to predict interaction between phases for non-homogenous non-equilibrium flow. Hydraulic volumes are analysed using 1D, 2D, 3D or lumped approach and can have any number of 1D heat structures. In addition, models for all engineering devices (pumps, fans, valves, heat exchangers, etc), usually found in NPP containments, are available.

The IRIS drywell model developed with GOTHIC code has been built gradually, starting from a lumped volume approach. Capability to model some recirculation within containment drywell is required, to address e.g. initial displacement of non-condensables to PSS tanks in real modelling of IRIS containment, and even most simple lumped volume GOTHIC model of the drywell assumes at least two volumes connected at top and bottom for drywell representation. A more realistic simulation is based on a subdivided volume approach, closer to the RELAP5 sliced model given by 1D components. GOTHIC drywell volume is comprised thus of 64 subvolumes (4 axial levels, provided with a square matrix 4x4 each one). It should be mentioned that in both, RELAP5 sliced 1D approach with lateral flows and GOTHIC 3D subdivided approach, approximate height of the drywell is kept, but empty homogenous volume is assumed with all lateral dimensions determined according to considered free drywell volume. That means there are no pressure losses modelled in RELAP5 lateral junctions and there are no obstructions or porosity fractions taken into account in GOTHIC 3D volumes. As far as GOTHIC heat structure modelling is concerned, a preliminary concentrated thermal structure nodalization has been improved into a multi-node concept.

Concentrated heat structure approach deals with two spanned thermal conductors, shared over a rectangular group of contiguous cells at top and bottom of subdivided volume, and simulating respectively steel liner (top) and operating deck concrete (bottom). More realistic heat structures are obtained following a distributed scheme, where the external spanned conductor modelling containment liner is subdivided in more conductors, surrounding completely the subdivided drywell volume (Figure 9). Boundary related information with side heat transfer can be hence properly accounted, reproducing local effects and distinguishing between how steam condensation is provided at the top of the drywell and on its lateral walls. Natural convection is handled in different ways for vertical and horizontal part of the structures too.

Break terms are again employed as boundary conditions, linked to drywell volume with the respective flow paths. Break

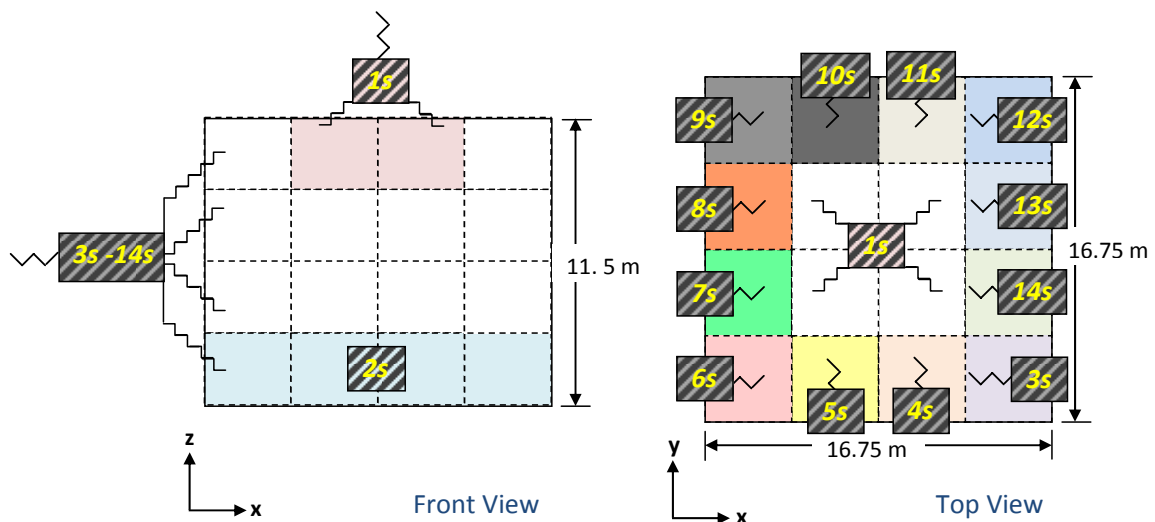

Figure 9 - IRIS drywell nodalization for the GOTHIC code: distributed thermal conductor approach.

pressure, temperature, flow and liquid fraction (both for RV side and DVI side of the break) dependence with time is provided with suitable forcing functions.

## 4 RESULTS AND DISCUSSION

### 4.1 Preliminary comparison between GOTHIC and RELAP5 models

The results obtained with RELAP5 nodalization of IRIS drywell and with preliminary GOTHIC model, based on a subdivided volume with attached concentrated heat structures at top and bottom, are discussed in this Section.

The multi-volume nodalization permits in GOTHIC a better reconstruction of the accident progression, reproducing possible local 3D effects of internal recirculating flows and thermal stratification within the steam released. Direct condensation options presented in Section 2 have been compared, and the different HTC's predicted are shown in Figure 10. Gido-Koestel correlation displays, as expected, a strong non-conservative peak at the beginning of the transient. The influence on containment response of the different HTC's calculated is presented in Figure 11 in terms of drywell temperature, which is a good representative parameter, being the most important signal of energy release within containment atmosphere. Uchida correlation, in particular with its modified version, predicts the highest peak and this conservative feature confirms its applicability to IRIS safety analyses.

RELAP5 calculation results are shown in Figure 10 and Figure 11 too. The sliced approach allows addressing main parameter trend along drywell height. In these graphs, however, just the variables predicted in the 12<sup>th</sup> volume of drywell pipes are provided. HTC values predicted in lower volumes are unrealistically high due to large lateral flows. The whole concern is illustrated in Figure 12, where the HTC distribution within the drywell is reported. Unrealistic values, more proper e.g. to in-tube condensation [42], are calculated for lower hydraulic volumes. Break source insertion causes indeed a great disturbance in the lower part of drywell nodalization, making heat transfer rate calculation not reliable. The main reason can be found in the big overprediction of recirculation phenomena, as it is evident when comparing the recirculating mass flow rates assessed by GOTHIC CFD-like model (Figure 13) with those assessed by RELAP5 lateral junctions (Figure 14). The lower internal natural circulation is calculated for the higher drywell elevations, but the prediction is still one order of magnitude bigger than GOTHIC results.

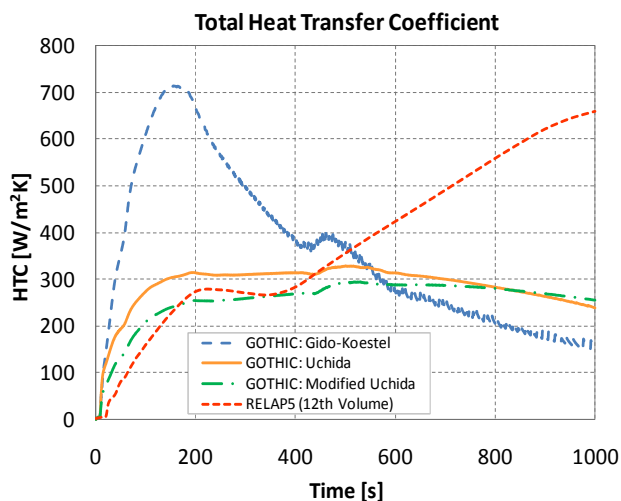

Figure 10 - Total HTC as predicted by GOTHIC preliminary model and RELAP5 code.

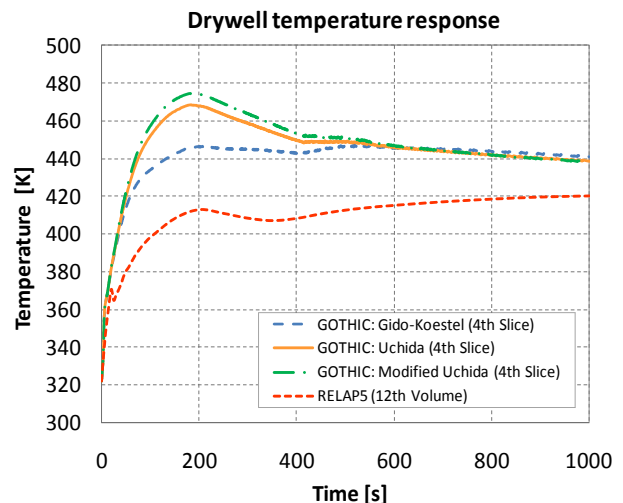

Figure 11 - Drywell temperature as predicted by GOTHIC preliminary model and RELAP5 code.

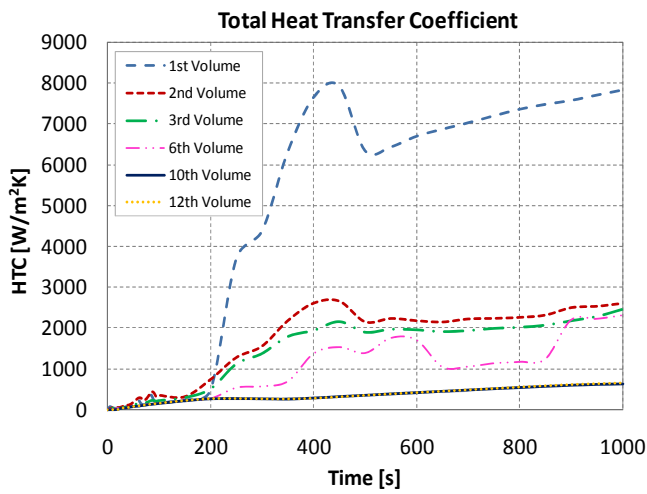

Figure 12 - Total HTC distribution within the drywell, as predicted by RELAP5 code.

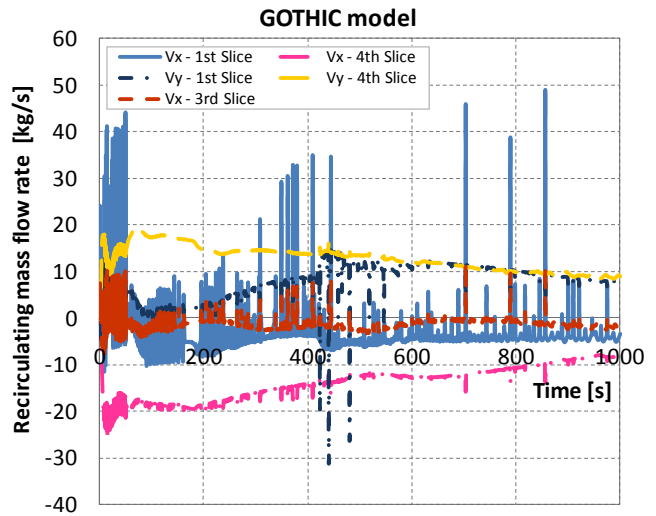

Figure 13 - Internal natural circulation flows as predicted by GOTHIC code.

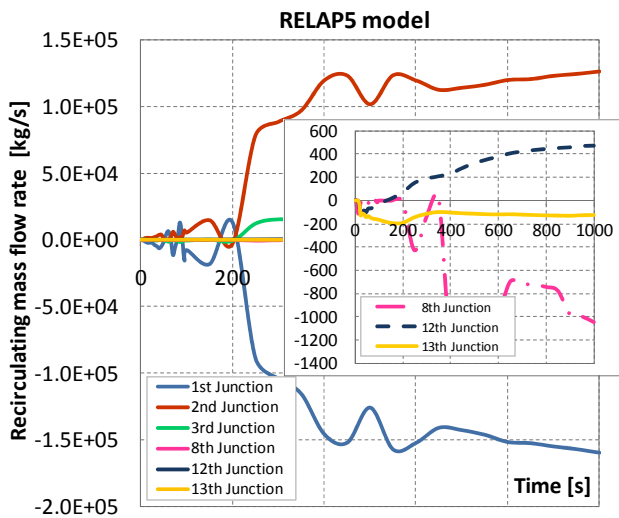

Figure 14 - Internal natural circulation flows as predicted by RELAP5 code.

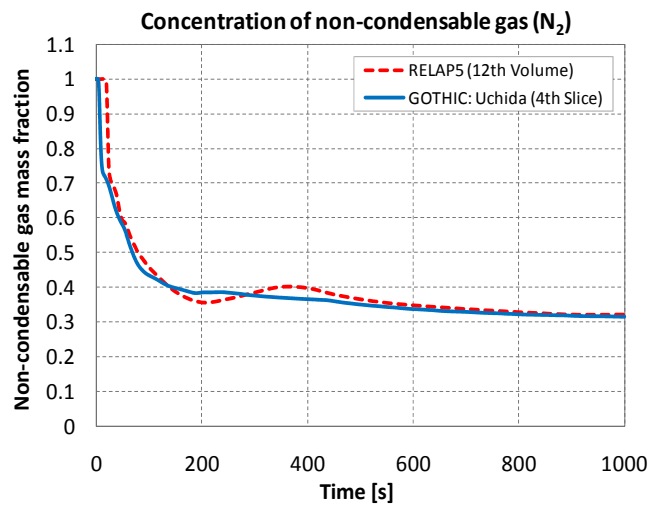

Figure 15 - Non-condensable gas mass fraction as calculated with GOTHIC and RELAP5 codes.

The most important parameter influencing investigated containment response to a SBLOCA is non-condensable gas redistribution within drywell atmosphere. The quantitative agreement between GOTHIC and RELAP5 calculations of non-condensable gas mass fraction trend (considered upper portion of the drywell) is still satisfactory (Figure 15). Beside some local recirculation phenomena, the asymptotic behaviour of both the models has to be the same, owing to the same boundary conditions imposed (the same initial amount of  $N_2$  and the same introduced amount of liquid which evaporates to steam). More differences between RELAP5 and GOTHIC predictions could be expected in overall containment model calculations, when e.g. part of the noncondensables is vented to PSS tanks and finally redistributed between reactor coolant system and containment. If the full coupled model developed for IRIS transient analyses is

referenced, non-condensable gas redistribution within the different containment compartments can be easily followed thanks to an additional containment visualization tool recently produced for the GOTHIC code (Figure 16).

Default options considered for GOTHIC and RELAP5 simulations, however, turn into different drywell temperature responses. It is shown that steam superheating is predicted with GOTHIC (Figure 17), whereas the release of saturated steam is calculated with RELAP5 (Figure 18) (temperature transient fits drywell pressure response).

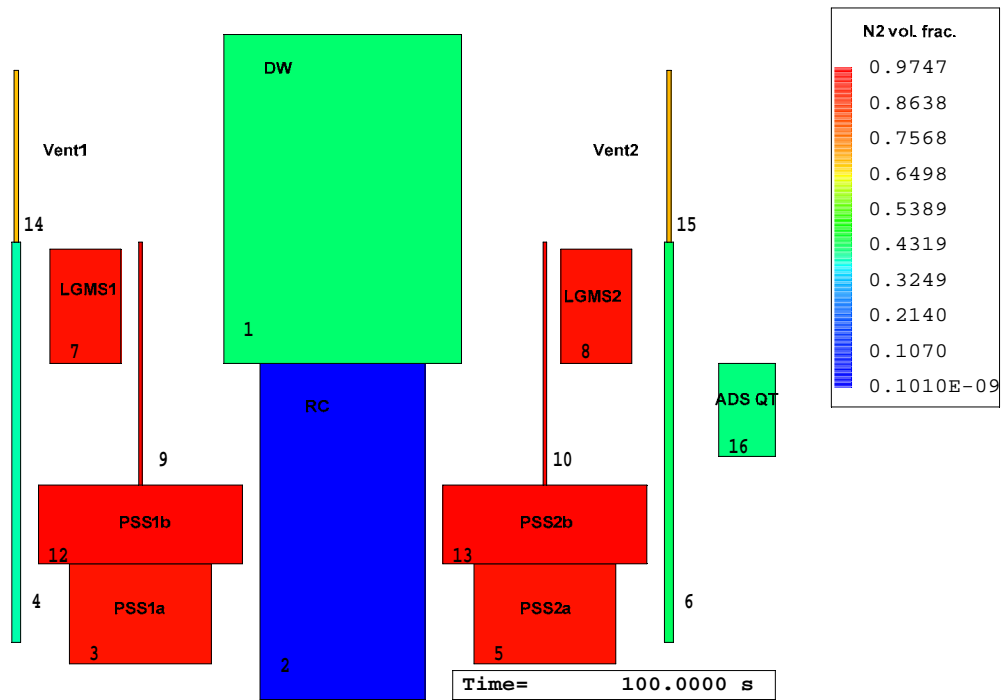

Figure 16 - Distribution of  $N_2$  volume fraction within volumes of full containment model at 100 s (DW, RC, PSS, LGMS, ADS, QT and vent pipes).

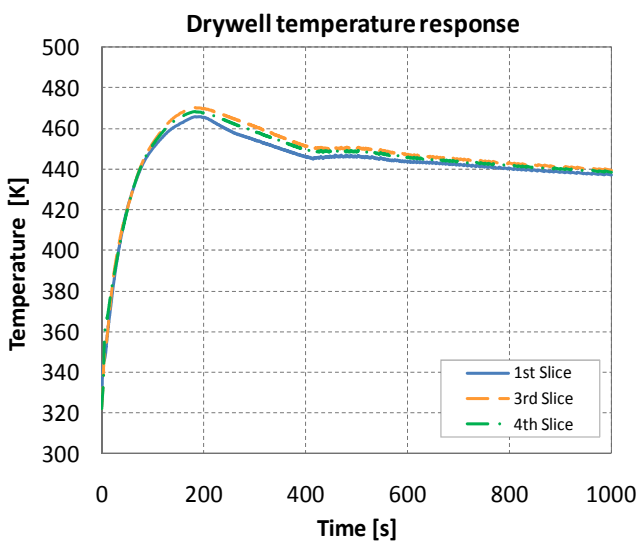

Figure 17 - Drywell temperature stratification as predicted by GOTHIC preliminary model (with reference to Uchida correlation).

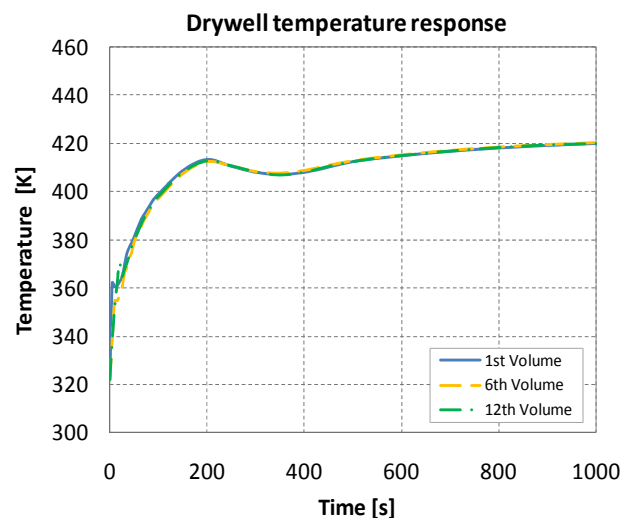

Figure 18 - Drywell temperature stratification as predicted by RELAP5 code.

## 4.2 Presence of droplets in GOTHIC break flow

Several sensitivity studies have been provided with the GOTHIC model, investigating the influence of different parameters such as the natural convection contribution to the heat transfer and the relative humidity of drywell atmosphere. The most influencing action on system response prediction was found to be the activation of droplets presence in a fluid delivered by GOTHIC flow boundary conditions (simulating flow coming from the break/cavity after DVI break opening). The complete conversion of the liquid flow into droplets of the specified size is assumed.

The presence of the droplets during the reactor vessel blowdown increases heat exchange surface between discharged fluid and containment atmosphere, turning into a higher evaporation rate and an increase in containment pressure. More heat is taken for evaporating the liquid, hence a reduction of containment temperature increase occurs. A larger steam condensation is driven by the larger evaporation, influencing system behaviour on the long term. These effects are evident in Figure 19, where a sensitivity study on the considered Droplets Diameter (DD) is provided.

The most important consequence given by the activation of the droplets presence in flow boundary conditions is the cancellation of steam superheating within containment atmosphere (Figure 20). The droplets presence in discharged fluid during blowdown phase of the transient is usual assumption adopted in classical SAR Chapter 6 licensing containment calculations. It is just noticed, however, that droplets presence within the boundary flow is properly correct assumption just for the first period of time after the break opening, when pressure difference is still high. Droplet phase discharge during the whole transient could be as inexact as continuous flow liquid discharge option. A suitable forcing function should be considered at the boundary conditions to define properly droplet phase and liquid phase discharge dependence with time. Even though in this calculations droplets presence has been assumed during all 1000 s of the analyzed discharge, in real modelling of IRIS SBLOCA on DVI line the latter might be the proper assumption till, for example, ADS opening (~200 s after the break). Droplets presence within the break flow will be indeed reduced following the pressure difference decrease between RV and RC, no matter what caused the pressure equalization.

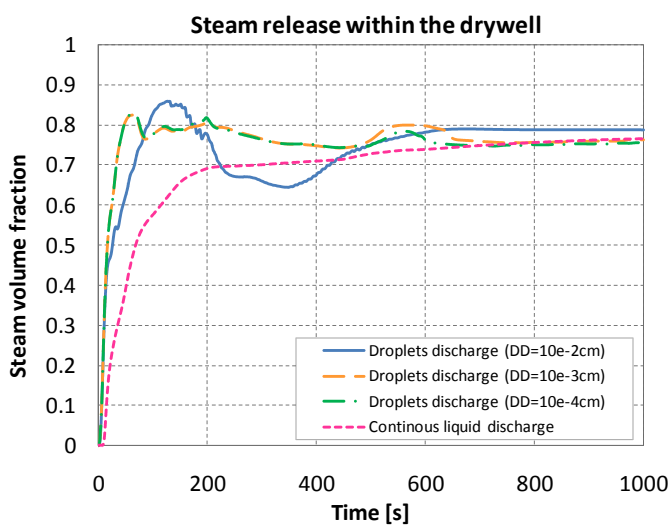

Figure 19 - Effects of the droplets discharge model on the production of steam.

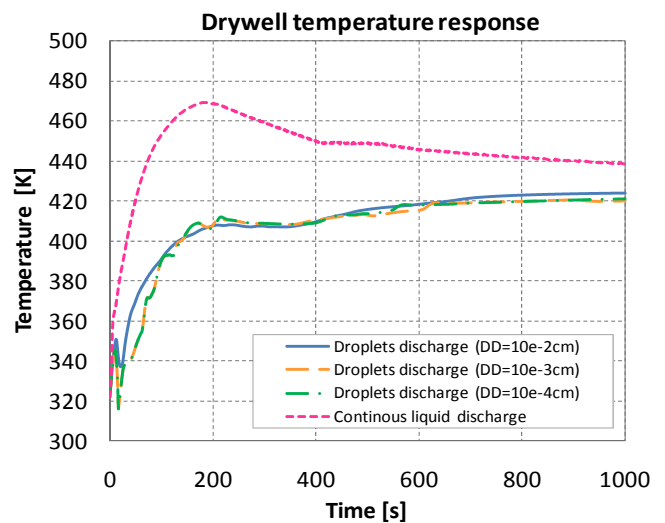

Figure 20 - Effects of the droplets discharge model on drywell temperature response.

### 4.3 More realistic containment model developed with GOTHIC code

GOTHIC capabilities in providing the most realistic simulation of IRIS containment are explored within this Section. Multi-node concept applied to thermal conductor representing drywell steel liner is discussed. The option to introduce break discharge in form of droplets is considered.

Distributed heat structures permit to address boundary related information by reproducing the local effects of condensation process. The various zones of the drywell can be better differentiated. HTC distribution is shown in Figure 21, depicting several heterogeneities among the different sides of the containment. It is mainly evident how a concentrated thermal conductor attached to the top of the drywell is not in position to predict the heat transfer peak establishing on the lateral walls at the beginning of the transient. The differences are due to different convection parts of the heat transfer coefficient and to different non-condensable gas fractions. According to the higher transfer rates, containment pressure peak is noticeably reduced following the distributed heat structure approach. Such more realistic containment model predicts a pressure peak about 0.5 bar lower than preliminary model with steel heat structures connected just at the top of the model, as shown in Figure 22.

Subdivided containment volume used in GOTHIC calculations, together with liner heat structure distributed to bounding cells of DW volume, can put some insight in local transient behaviour of different DW locations. In Figure 23, N<sub>2</sub> volume fractions at two opposite locations in bottom (subvolumes 1 and 16) and top (subvolumes 49 and 64) layer, both of DW with subdivided volume and concentrated liner (label sub\_dd) and of DW with subdivided volume and distributed heat structures (label sub\_dds), are shown. The same distributions for temperature of gas and steam mixture are shown in Figure 24. Initial presence of steam in the lower part of the model due to the break discharge located at the DW bottom (two central positions) causes a decrease in N<sub>2</sub> volume fraction and an increase in gas temperature. The model with distributed heat structure demonstrates lower temperatures in peripheral cells and some coupling between N<sub>2</sub> distributions and gas temperatures/heat transfer to the walls (Figure 25 and Figure 26). Main dependency between N<sub>2</sub> and temperature distribution is still disturbed by local recirculation and influence of the discharged fluid. Finally, mainly homogenous conditions are established after about 600 s.

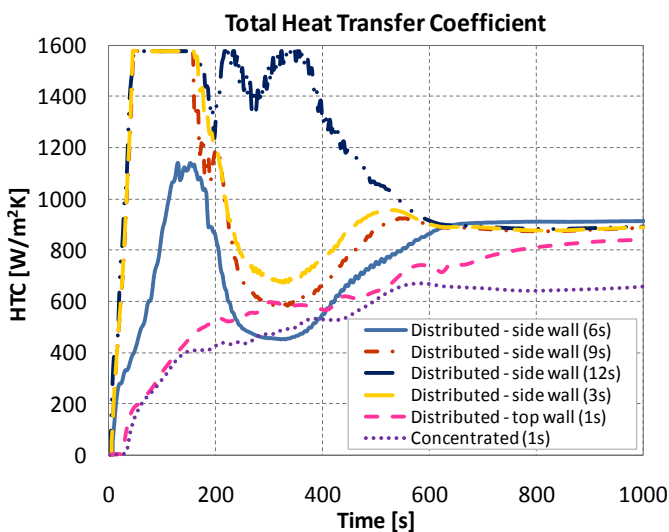

Figure 21 - Total HTC distribution within the drywell, as predicted with GOTHIC more realistic containment model.

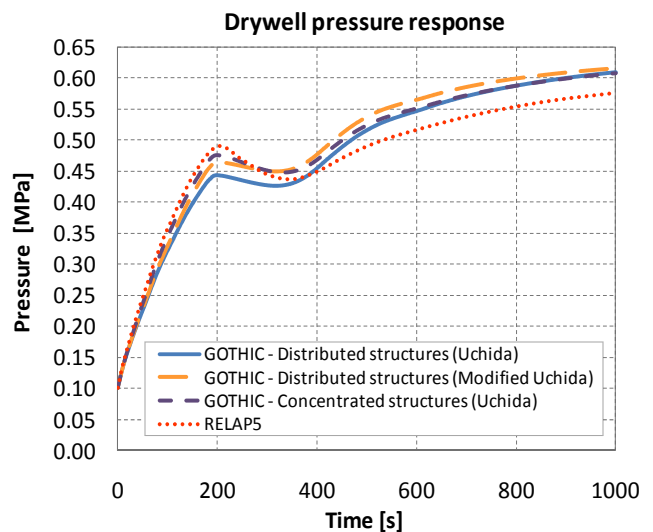

Figure 22 - SBLOCA on DVI line: DW pressure response.

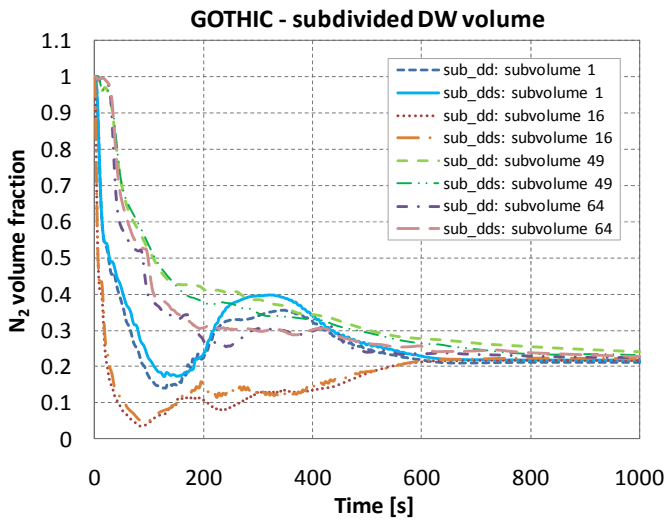

Figure 23 -  $N_2$  volume fractions for two locations at the bottom (subvolumes 1 and 16) and the top (subvolumes 49 and 64) of DW.

[sub\_dd = subdivided volume and concentrated heat structures; sub\_dds = subdivided volume and distributed heat structures]

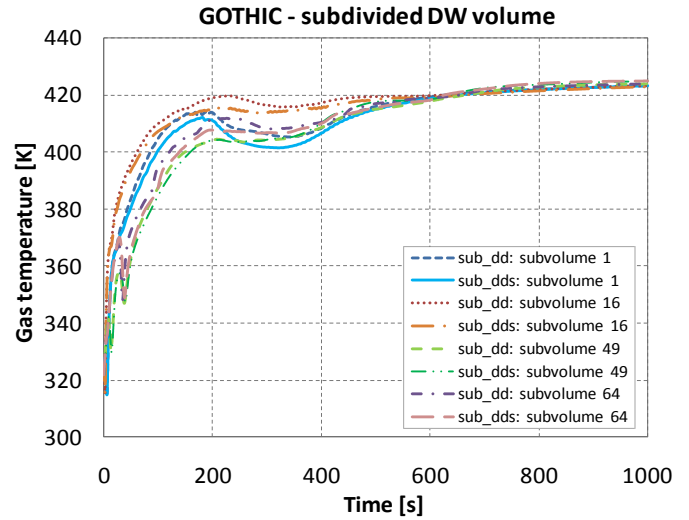

Figure 24 - Gas mixture temperatures for two locations at the bottom (subvolumes 1 and 16) and the top (subvolumes 49 and 64) of DW.

[sub\_dd = subdivided volume and concentrated heat structures; sub\_dds = subdivided volume and distributed heat structures]

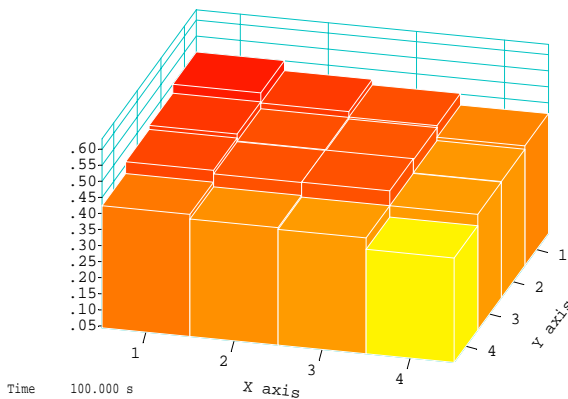

Figure 25 - Lateral distribution of  $N_2$  volume fraction in axial layer 2 at 100 s (subdivided case with liner concentrated at the top).

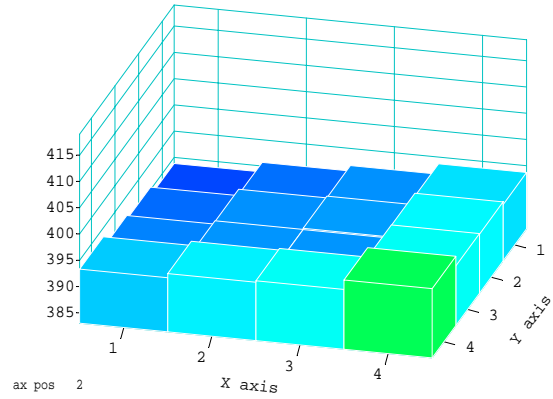

Figure 26 - Lateral distribution of gas temperature in axial layer 2 at 100 s (subdivided case with liner concentrated at the top).

In early phase of the transient, lower temperatures experienced by the fluid in case of distributed heat structures are clearly visible, as shown in Figure 27 and Figure 28 for two different liner configurations (simulation time  $t = 100$  s - in all cases the discharge with droplets presence is analysed).

Once the most accurate containment model with GOTHIC dedicated code is obtained, RELAP5 predictions on drywell response to SBLOCA on DVI line can be assessed. Notwithstanding the various shortcomings highlighted in Section 4.1, DW pressure response (Figure 22) and DW temperature response (Figure 29) show that RELAP5 code is capable of matching satisfactorily GOTHIC model predictions.

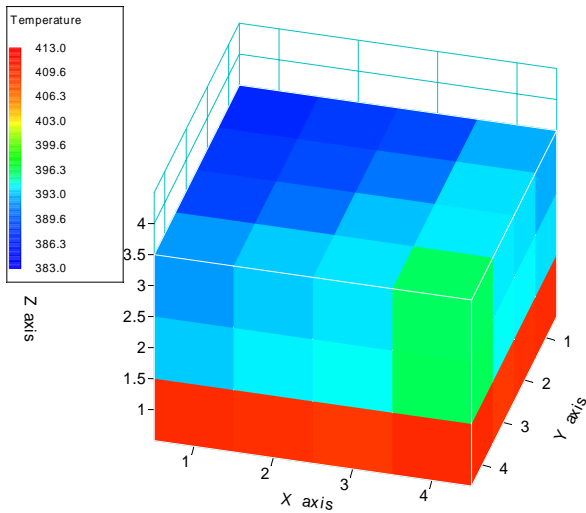

Figure 27 - 3D distribution of gas temperature in model with liner heat structure concentrated at the top of DW (t=100 s).

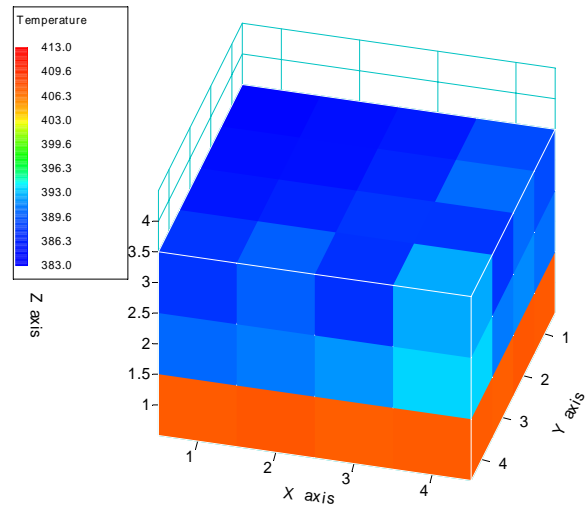

Figure 28 - 3D distribution of gas temperature in model with liner heat structure distributed among peripheral DW cells (t=100 s).

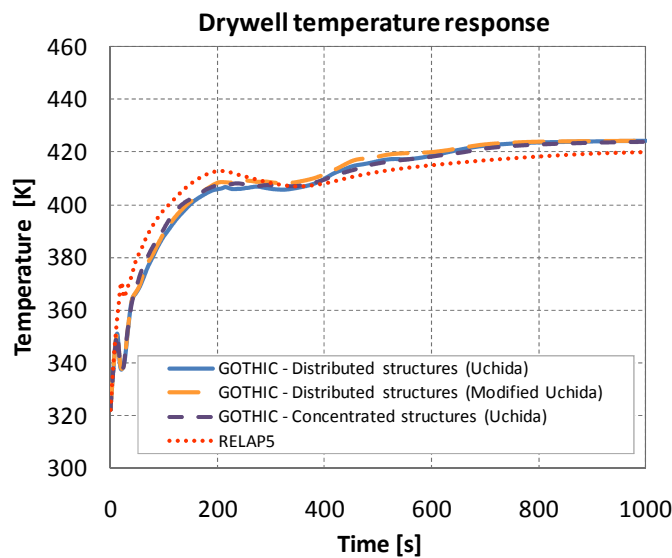

Figure 29 - SBLOCA on DVI line: DW temperature response.

## 5 CONCLUSIONS

Several issues concerning IRIS containment modelling for a SBLOCA transient have been analyzed with the two codes GOTHIC and RELAP5. The same boundary conditions (break mass and energy sources) and the same presence of heat structures have been applied to a simplified model of the drywell alone, in order to quantify how the utilization of different codes with different heat transfer packages for steam condensation will influence predictions on the same postulated accident. Verification of the capability of the "pipe-oriented" code RELAP5 in large volume transient analyses, together with developing better representation of DW using GOTHIC subdivided volume option, has been one



of the additional objectives of the work. To the aim, system response has been investigated with regard to global criteria (drywell temperature and pressure response) and local criteria (total HTC distribution and internal recirculating flows) based on which RELAP5 code has been assessed outside its validation matrix. The main characteristics of IRIS drywell modelling with GOTHIC and RELAP5 codes have also been presented in this document.

The key parameter influencing condensation of the steam released has been indicated in the amount of non-condensable gas present within the containment. The empirical Uchida correlation has been identified as appropriate way to model this effect under IRIS containment conditions. GOTHIC heat transfer package offers also a modified version of Uchida correlation, which looks promising for its more conservative behaviour. RELAP5 used the entire time default heat transfer correlation package with film condensation taken into account.

A fair qualitative agreement has been obtained between GOTHIC and RELAP5 predictions on IRIS drywell response. Though internal natural circulation has been remarkably overestimated by RELAP5, its diffusion method for dealing with condensation phenomena in presence of non-condensable has showed to be adequate to match Uchida predictions obtained with GOTHIC. RELAP5 containment two-pipe-with-junction model with proper choice of lateral junctions can be hence considered as an acceptable tool for addressing large volumes in transient analyses. That conclusion can help in finding explanations for differences present when comparing IRIS coupled code calculations and SPES3 RELAP5 calculations performed during design verification of SPES3 facility.

Taking into account development of improved DW model, the option to include droplets in break flow boundary conditions is the most influencing parameter for GOTHIC simulations (from point of view of predicting drywell pressure and temperature). The higher evaporation rate causes an increase in containment pressure and a reduction in temperature due to the larger condensation rate. This leads to the elimination of steam superheating, as expected from the RELAP5 calculations on the test facility SPES3. Distributed heat structures attached to subdivided 3D volume have permitted finally a more physical representation of IRIS drywell, predicting more realistic condensation HTC distribution and pressure peak estimation.



## ACRONYMS

AB	Auxiliary Building
ADS	Automatic Depressurization System
AP600	Advanced Pressurized reactor – 600 MWe
AP1000	Advanced Pressurized reactor – 1000 MWe
BWR	Boiling Water Reactor
CVCS	Chemical Volume and Control System
DD	Droplets Diameter
DVI	Direct Vessel Injection
DW	Dry-Well
EBT	Emergency Boration Tank
EHR	Emergency Heat Removal System
EPRI	Electric Power Research Institute
GOTHIC	Generation Of Thermal-Hydraulic Information for Containments
HTC	Heat Transfer Coefficient
IRIS	International Reactor Innovative and Secure
ISP-42	International Standard Problem number 42
LBLOCA	Large Break LOCA
LGMS	Long-term Gravity Make-up System
LOCA	Loss Of Coolant Accident
LWR	Light Water Reactor
NEA	Nuclear Energy Agency
NPP	Nuclear Power Plant
NRC	Nuclear Regulatory Commission
OECD	Organization for Economic Co-operation and Development
PANDA	PASSive Nachwärmeabfuhr- und Druckabbau- testanlage (passive decay heat removal and depressurization test facility)
PCCS	Passive Containment Cooling System
PIRT	Phenomena Identification and Ranking Table
PSS	Pressure Suppression System
QT	Quench Tank
RC	Reactor Cavity
RELAP	Reactor Excursion and Leak Analysis Program
RV	Reactor Vessel
RWST	Refuelling Water Storage Tank
SAR	Safety Analysis Report
SBLOCA	Small Break LOCA
SBWR	Simplified Boiling Water Reactor
SIET	Società Informazioni Esperienze Termoidrauliche



(company for information on thermal-hydraulic experimentation)  
SPES Simulatore Per Esperienze di Sicurezza  
(simulator for safety tests)  
T/H Thermal/Hydraulic

## NOMENCLATURE

$h$  heat transfer coefficient [ $W/(m^2 \cdot K)$ ]  
 $q$  heat flux [ $W/m^2$ ]  
 $T$  temperature [K]  
 $t$  time [s]  
 $W$  non-condensable gas mass fraction [%wt]

### Greek symbols

$\rho$  density [ $kg/m^3$ ]

### Subscripts

$b$  bulk  
 $cond$  condensation through gas-vapour boundary layer  
 $conv$  convection through gas-vapour boundary layer  
 $film$  liquid film on the wall  
 $g$  non-condensable gas species  
 $T$  total  
 $v$  vapour phase  
 $w$  wall



## REFERENCES

- [1] Tortora, G., Application of Fractional Scaling Analysis for IRIS and SPES3 Containment Vessels pressure responses during DVI-SBLOCA event, Master of Science Thesis, Politecnico di Milano, Milan, July 2009.
- [2] Papini, D., Cammi, A., Ricotti, M., Grgić, D., Analysis of Different Containment Models for IRIS Small Break LOCA, using GOTHIC and RELAP5 Codes, Proc. Int. Conf. Nuclear Energy for New Europe 2009, Bled, Slovenia, 2009.
- [3] Papini, D., Grgić, D., Cammi, A., Ricotti, M., Analysis of different containment models for IRIS Small Break LOCA, using GOTHIC and RELAP5 codes, *Nucl. Eng. Des.*, In Press.
- [4] Sawyer, C., Thermal/hydraulic challenges for the SBWR, Proc. 5th Int. Top. Meet. on Reactor Thermal-Hydraulics, NURETH-5 'Towards the Next Generation of Nuclear Power Reactors', Salt Lake City, UT, USA, vol. 1, pp. 21-24, 1992.
- [5] Kennedy, M.D., Peters, F.E., Carelli, M.D., Pieczynski, A.T., Advanced PWR passive containment cooling system testing, Proc. ARS'94 Int. Top. Meet. On Advanced Reactor Safety, Pittsburgh, PA, USA, vol. 1, pp. 249-256, 1994.
- [6] Schulz, T.L., Westinghouse AP1000 advanced passive plant, *Nucl. Eng. Des.* 236, 1547-1557, 2006.
- [7] Spencer, D.R., Woodcock, J., Wright, O.F., Gresham, J.A., Westinghouse-Gothic comparison with passive containment cooling system tests scaling evaluation and analysis, Proc. 2nd ASME/JSME Nuclear Engineering Joint Conf., San Francisco, CA, USA, 1993.
- [8] Carelli, M.D., Conway, L.E., Oriani, L., Petrović, B., Lombardi, C.V., Ricotti, M.E., Barroso, A.C.O., Collado, J.M., Cinotti, L., Todreas, N.E., Grgić, D., Moraes, M.M., Boroughs, R.D., Ninokata, H., Ingersoll, D.T., Oriolo, F., The design and safety features of the IRIS reactor, *Nucl. Eng. Des.* 230, 151-167, 2004.
- [9] Santini, L., Papini, D., Ricotti, M.E., Experimental Characterization of a Passive Emergency Heat Removal System for a GenIII+ Reactor, *Science and Technology of Nuclear Installations* Volume 2010, Article ID 864709, 12 pages, doi:10.1155/2010/864709, 2010.
- [10] U.S. NRC, Appendix K to Part 50 – ECCS Evaluation Models, 10CFR50, December 2005.
- [11] Sato, T., Kojima, Y., Variations of a passive safety containment for a BWR with active and passive safety systems, *Nucl. Eng. Des.* 237, 74-86, 2007.
- [12] Oriani, L., Conway, L.E., Grgić, D., Small Break Loss of Coolant Accident Analysis for the International Reactor Innovative and Secure (IRIS). Proc. 5th Int. Conf. on Nuclear Option in Countries with Small and Medium Electricity Grids, Dubrovnik, Croatia, 2004.
- [13] Carelli, M., Conway, L., Dzodzo, M., Maioli, A., Oriani, L., Storrick, G., Petrović, B., Achilli, A., Cattadori, G., Congiu, C., Ferri, R., Ricotti, M., Papini, D., Bianchi, F., Meloni, P., Monti, S., Berra, F., Grgić, D., Yoder, G., Alemberti, A., The SPES3 Experimental Facility Design for the IRIS Reactor Simulation, *Science and*



- Technology of Nuclear Installations* Volume 2009, Article ID 579430, 12 pages, doi:10.1155/2009/579430, 2009.
- [14] Oriani, L., Conway, L.E., Grgić, D., Čavlina, N., Berra, F., Ricotti, M., Ambrogi, G., Oriolo, F., IRIS Safety Features and Analysis of Non-LOCA Transients and Accidents. Proc. ANS/ENS Int. Meet. GLOBAL 2003, New Orleans, Louisiana, USA, 2003.
- [15] Larson, T.K., Moody, F.J., Wilson, G.E., Brown, W.L., Frepoli, C., Hartz, J., Woods, B.G., Oriani, L., IRIS small break LOCA phenomena identification and ranking table (PIRT), *Nucl. Eng. Des.* 237, 618-626, 2007.
- [16] Grgić, D., Oriani, L., Conway, L.E., Development Status and Preliminary Validation of a Coupled RELAP/GOTHIC Code for IRIS Small Break LOCA Analysis, Proc. 5th Int. Conf. on Nuclear Option in Countries with Small and Medium Electricity Grids, Dubrovnik, Croatia, 2004.
- [17] Ferri, R., Congiu, C., SPES3-IRIS facility nodalization for RELAP5 Mod. 3.3 code and steady state qualification, SIET 01 423 RT 08 Rev.0, January 2009.
- [18] U.S. NRC Nuclear Safety Analysis Division, RELAP5/MOD3.3 Code Manual, NUREG/CR-5535/Rev 1, December 2001.
- [19] Petruzzi, A., D'Auria, F., Galassi, G.M., Analysis of OECD/CSNI ISP-42 PANDA Experiment by RELAP5/Mod3.2 Code, Dipartimento Di Ingegneria Meccanica, Nucleare E Della Produzione, Università di Pisa, Pisa, DIMNP NT 451 (01), October 2001.
- [20] Del Nevo, A., Manfredini, A., Oriolo, F., Paci, S., Oriani, L., Integrated analysis for a Small Break LOCA in the IRIS reactor using MELCOR and RELAP5 codes, Proc. 5th Int. Conf. on Nuclear Option in Countries with Small and Medium Electricity Grids, Dubrovnik, Croatia, 2004.
- [21] Aksan, N., Overview on PANDA test facility and ISP-42 tests data base, in Natural Circulation in Water Cooled Power Plants, IAEA-TECDOC-1474, pp. 415-431, 2005.
- [22] Green, J., Almenas, K., An overview of the primary parameters and methods for determining condensation heat transfer to containment structures, *Nucl. Saf.* 37 (1), 26-47, 1996.
- [23] Collier, J.C., Convective Boiling and Condensation, McGraw-Hill, New York, 1981.
- [24] Uchida, H., Oyama, A., Togo, Y., Evaluation of post-incident cooling systems of light-water power reactors, Proc. 3rd Int. Conf. on the Peaceful Uses of Atomic Energy, Geneva, Switzerland, vol. 13, pp. 93-102, 1965.
- [25] Vierow, K.M., Schrock, V.E., Condensation in a natural circulation loop with a noncondensable gas present, Proc. Int. Conf. on Multiphase Flows '91, Tsukuba, Japan, pp. 183-186, 1991.
- [26] Siddique, M., Golay, M.W., Kazimi, M.S., Local heat transfer coefficients for forced-convection condensation of steam in a vertical tube in the presence of a noncondensable gas, *Nucl. Technol.* 102, 386-402, 1993.
- [27] Kuhn, S.Z., Schrock, V.E., Peterson, P.F., An investigation of condensation from steam-gas mixtures flowing downward inside a vertical tube, *Nucl. Eng. Des.* 177, 53-69, 1997.



- [28] Dehbi, A.A., Golay, M.W., Kazimi, M.S., Condensation experiments in steam-air and steam-air-helium mixtures under turbulent natural convection, National Conference of Heat Transfer, AIChE Symp. Ser., 19-28, 1991.
- [29] Anderson, M.H., Herranz, L.E., Corradini, M.L., Experimental analysis of heat transfer within the AP600 containment under postulated accident conditions, *Nucl. Eng. Des.* 185, 153-172, 1998.
- [30] Sparrow, E.M., Lin, S.H., Condensation heat transfer in the presence of a noncondensable gas, *J. Heat Transf.* 86, 430-436, 1964.
- [31] Ghiaasiaan, S.M., Kamboj, B.K., Abdel-Khalik, S.I., Two-fluid modeling of the condensation in the presence of noncondensable in two-phase flows, *Nucl. Sci. Eng.* 119, 1-17, 1995.
- [32] Yuann, R.Y., Schrock, V.E., Chen, X.M., Numerical modeling of condensation from vapor-gas mixtures for the forced downflow inside a tube, Proc. 7th Int. Top. Meet. on Reactor Thermal-Hydraulics, NURETH-7, Saratoga Springs, NY, USA, pp. 377-401, 1995.
- [33] Kim, M.H., Corradini, M.L., Modeling of condensation heat transfer in a reactor containment, *Nucl. Eng. Des.* 118, 193-212, 1990.
- [34] Peterson, P.F., Schrock, V.E., Kageyama, T., Diffusion layer theory for turbulent vapour condensation with non-condensable gases, *J. Heat Transf.* 115, 998-1003, 1993.
- [35] Herranz, L.E., Muñoz-Cobo, J.L., Verdú, G., Heat transfer modeling in the vertical tubes of the passive containment cooling system of the simplified boiling water reactor, *Nucl. Eng. Des.* 178, 29-44, 1997.
- [36] Herranz, L.E., Anderson, M.H., Corradini, M.L., A diffusion layer model for steam condensation within the AP600 containment, *Nucl. Eng. Des.* 183, 133-150, 1998.
- [37] Ambrosini, W., Forgiione, N., Manfredini, A., Oriolo, F., On various forms of the heat and mass transfer analogy: Discussion and application to condensation experiments, *Nucl. Eng. Des.* 236, 1013-1027, 2006.
- [38] Ganguli, A., Patel, A.G., Maheshwari, N.K., Pandit, A.B., Theoretical modeling of condensation of steam outside different vertical geometries (tube, flat plates) in the presence of noncondensable gases like air and helium, *Nucl. Eng. Des.* 238, 2328-2340, 2008.
- [39] EPRI, GOthic Containment Analysis Package: Technical Manual, Version 7.2a-Beta. NAI 8907-06 Rev 16, July 2005.
- [40] Gido, R.G., Koestel, A., Containment condensing heat transfer, Proc. ANS/ASME/AIChE 2nd Int. Top. Meet. on Nuclear Thermalhydraulics, Santa Barbara, CA, USA, 1983.
- [41] Peterson, P.F., Theoretical basis for the Uchida correlation for condensation in reactor containments, *Nucl. Eng. Des.* 162, 301-306, 1996.
- [42] Papini, D., Cammi, A., Modelling of Heat Transfer Phenomena for Vertical and Horizontal Configurations of In-Pool Condensers and Comparison with Experimental Findings, *Science and Technology of Nuclear Installations* Volume 2010, Article ID 815754, 16 pages, doi:10.1155/2010/815754, 2010.



## **ANNEX I – IRIS CONFERENCE CALL MINUTES**

*In order to show the continuous participation of Politecnico di Milano (POLIMI) in the follow-up of the SPES3 program, most significant Conference Call Minutes are reported in this Appendix. Conference Calls are weekly telephone meetings between IRIS Team members, where different topics – mainly devoted to facility design, numerical simulation with RELAP5 code and construction at SIET labs, and to IRIS transient and scaling analyses as well – are discussed. Actions are decided and subsequently accomplished. Personal POLIMI contributions are hereby highlighted.*



2009 January 30<sup>th</sup>

**88<sup>th</sup> Conference Call on IRIS Integral Testing**

Participants:

D. Grgic (FER) D. Papini, M. Ricotti (POLIMI) G. Tortora (POLIMI/WEC) C. Congiu, R. Ferri (SIET) S. Bergamo, D. Lioce (UNIPI/WEC) M. Dzodzo, G. Storrack (WEC)
---

1. We approved the minutes of the January 16<sup>th</sup> conference call.
2. Facility design
  - There were no design changes this week.
  - SIET has been working on design documentation and equipment specifications.
    - SIET finished the nodalization document and ENEA approved it. They will issue it next week.
    - SIET will finish the facility design documentation in mid-February. This consists of the following five parts:
      - Summary
      - Tanks
      - Piping
      - Valves
      - Instrumentation
  - SIET is documenting the design of the new load-bearing structure, and will finish by mid-February.
3. IRIS transient analyses
  - Issues at Krsko delayed Davor's work on the nodalization documentation. He will send the results by mid-February.
4. Scaling
  - Donato, Gaetano and Simone will finish their internships at Westinghouse next week. Their exit presentations are scheduled for Wednesday afternoon.
    - The dominant issue identified by all three scaling analyses (see attachments) is that the 10:1::SPES-3:IRIS scaling of the drywell area/volume ratio leads to too much heat transfer between the drywell atmosphere and vessel.
    - This leads to over-condensation at the beginning of transients (which reduces and delays the SPES-3 containment pressure peak) and superheated steam conditions (vs. saturated in IRIS) at the end, when the containment metal returns heat to the containment atmosphere.
    - These change the reactor vessel/containment coupling, resulting in different reactor vessel level responses in the later portions of the transients. There is good level agreement early in the transients because the reactor vessel response is initially decoupled from the containment response.



- There are differences in the heat structure models in the IRIS and SPES-3, and the response is sensitive to heat structures.
- Recommendations:

**Action [Roberta, after finishing the design documentation]: Re-run the SPES-3 analyses with an effective drywell area/volume ratio reduced to match IRIS (e.g., by insulating the inner surface of the drywell). This will help quantify how well insulating the inside of the drywell can improve the SPES-3 response.**

**Action [Davor, Davide]: Develop routines for R5 that reproduce the condensation correlations used in GOTHIC. This will help quantify the effect of differences between the RELAP/GOTHIC model used for IRIS and the RELAP model used for SPES-3. (Similar work on the EHRS HX is in progress)**

**Action [Milorad]: Prepare a recommendation and supporting justification (addressed to Gary and Mario) for modifying the facility design by insulating the inside of the containment. Gary and Mario will review and discuss this with ENEA.**

5. The next conference call will be on Friday, February 6<sup>th</sup>, 2009 at 9:00 a.m. US time, 3:00 p.m. EU time.



**2009 February 13<sup>th</sup>**  
**90<sup>th</sup> Conference Call on IRIS Integral Testing**

Participants:

F. Bianchi (ENEA) D. Grgic (FER) J. Carbajo (ORNL) C. Congiu, R. Ferri (SIET) M. Dzodzo, G. Storrack (WEC)
--

1. We approved the minutes of the February 6<sup>th</sup> conference call.
2. Facility design
  - There were no design changes this week.
  - SIET has been working on design documentation and equipment specifications.
    - SIET sent the nodalization document to ENEA last Monday (2 Feb.) ENEA will issue it next week (it should be available in the eRoom on Monday (9 Feb).
    - SIET started working on the transient analysis documentation.
    - The remaining final design documents are at ENEA for review.
    - SIET is finishing the instrumentation and dimensions on a few piping drawings.
  - Roberta finished the run started last week and uploaded it to the Westinghouse STC server. This run added a 1 mm. Teflon insulation layer to the inner surface of the drywell. Roberta has not had time to check the results.
3. IRIS transient analyses
  - Davor completed a run that increases the containment heat structures to include the total metal in the containment (LGMT, EBT, CVCS, upper missile shield, etc.). The result was a small reduction in maximum containment pressure.
  - Davor running a second case that couples external heat structures to the outside wall of the containment. This results in a lower containment peak pressure. (Roberta's runs have assumed insulated external tank surfaces).
  - Davor is preparing a run to match our present best estimate on real equipment heat structures. This run will assign individual heat structures to specific nodes within the containment model. This will give an estimate of the impact of distributed heat structures..
  - Davide will be visiting Zagreb for a month, starting in a few weeks, to help develop heat transfer correlations for the EHRS HX and the containment condensation (GOTHIC vs. RELAP). Davor will be able to provide a better schedule next week.
4. Scaling
  - Milorad was on vacation this week.
5. The next conference call will be on Friday, February 20<sup>th</sup>, 2009 at 9:00 a.m. US time, 3:00 p.m. EU time.



**2009 February 27<sup>th</sup>**  
**92<sup>nd</sup> Conference Call on IRIS Integral Testing**

Participants:

F. Bianchi (ENEA) D. Papini (POLIMI) J. Carbajo (ORNL) C. Congiu, R. Ferri (SIET) M. Dzodzo, G. Storrack (WEC)
--

1. We approved the minutes of the February 13<sup>th</sup> and 20<sup>th</sup> conference calls.

2. Facility design

- Fosco met with SIET and provided ENEA's comments on the technical documents (tanks, valves, piping, instrumentation). SIET is revising the documents to address the comments, and anticipates having them ready to issue in about 2 weeks.
- Roberta is writing the analysis document and will have it finished in about 2 weeks.
- SIET received information from Ray on information on where SIET can obtain a copy of NQA-1-1994. SIET is working under Part 1 of NQA-1, and believes that the other parts do not apply.

**Action Item: Gary to confirm with Westinghouse QA.**

- SIET received a request for IRIS information from Maire Technimont and asked how to proceed. Gary asked to have all such requests forwarded to him.
- Roberta provided plots of drywell pressure with and without a 1 mm. teflon insulating layer [see attachment 1, separate file]]. The initial pressure trend is closer to the IRIS trend but the peak pressure is similar. Westinghouse needs time to look at the results, but initially they look promising. Ultimately, we need to design an appropriate insulating structure.

3. IRIS transient analyses

- Davide provided preliminary results comparing the RELAP and GOTHIC drywell models [see attachment 2, separate file]. Of four condensation models, the Uchida is the preferred one in GOTHIC. The results suggest activating the GOTHIC droplet model for the reactor vessel blowdown. The results also show that the RELAP containment two-pipe-with-junction model overestimates internal natural circulation, but it is not clear how to do better.
- Davor is updating the containment model as discussed last week. He is also updating the model below for the containment structures below the operating deck
- Davide is in Zagreb to help develop heat transfer correlations for the EHRS HX and the containment condensation (GOTHIC vs. RELAP). This week, he looking at various condensing heat transfer options/effects.

4. Scaling

- Milorad reported that Gaetano redid his scaling analysis of the first part of the transient basing saturation temperature steam partial pressure, with little change in the final results.

5. The next conference call will be on Friday, March 6<sup>th</sup>, 2009 at 9:00 a.m. US time, 3:00 p.m. EU time.



2009 March 6<sup>th</sup>  
93<sup>rd</sup> Conference Call on IRIS Integral Testing

Participants:

F. Bianchi (ENEA) D. Grgic (FER) D. Papini (POLIMI) J. Carbajo (ORNL) C. Congiu, R. Ferri (SIET) M. Dzodzo, G. Storrack (WEC)
--

1. We approved the minutes of the February 27<sup>th</sup> conference calls.
2. Facility design
  - SIET is revising the design documents to address ENEA's comments as reported last week.
  - Paride Meloni provided ENEA's comments on the analysis document. Roberta is resolving those comments. This will take several weeks.
  - Cinzia is running two drywell sensitivity runs, one with Teflon insulation and one with changed heat transfer coefficients.
  - Fosco noted that the design specifications will be in Italian. These are not deliverables to ORNL or to Westinghouse. Gary responded that Westinghouse's interest in these is scheduler- we do not need to review these specifications.
3. IRIS transient analyses
  - Davor provided some results showing that using the GOTHIC droplet model for the break flow has a small influence on the containment pressure response. Using the droplet model eliminates the superheating but also generates more steam, leading to similar containment pressure responses. (When activated, GOTHIC assumes that all flow is droplet flow).
  - **It appears that the difference between the SPES-3 and IRIS results is real, and not due to differences in modeling.**
  - Davide has been working on a more realistic containment model.
  - Davide is also working on the EHRS pool model.
4. The next conference call will be on Friday, March 13<sup>th</sup>, 2009 at 9:00 a.m. US time, 3:00 p.m. EU time.



**2009 March 13<sup>th</sup>**  
**94<sup>th</sup> Conference Call on IRIS Integral Testing**

Participants:

F. Bianchi (ENEA) D. Papini (POLIMI) J. Carbajo (ORNL) C. Congiu, R. Ferri (SIET) G. Storrick (WEC)
---

1. We approved the minutes of the March 6<sup>th</sup> conference call.
2. Facility design
  - SIET continued working of facility documentation.
  - SIET is preparing the contract plan for the next fiscal year.
  - Annamaria Masetto is now working with SIET to develop instrumentation scaling based on the five RELAP cases.
  - Earlier, Milorad put some insulation property information in the eRoom with the idea of using this to line the containment drywell. Roberta noted that her runs using Teflon had a faster pressure rise early after a break, but the later portions of the transient did not show a significant difference in pressure response vs. the non-insulated case. Roberta believes that one reason that the SPES analysis result has a lower pressure peak than the IRIS analysis result is that the SPES runs have a larger volume.
  - Fosco noted that there is no funding available at this time for SIET to perform additional analyses.
  - There were no facility design changes this week.
3. IRIS transient analyses
  - Davide has been working on a more realistic containment model. The revised RELAP containment condensation correlations seem to be working. Davide will provide a containment drywell model summary in 2 weeks.
  - Davide looked at different ways to model the EHRS pool model. There were no major differences between using a single volume vs. more complex models. The single volume gave a higher heat transfer, but the difference was small.
4. The next conference call will be on Friday, March 27<sup>th</sup>, 2009 at 10:00 a.m. US time, 3:00 p.m. EU time.



**2009 April 17<sup>th</sup>**  
**97<sup>th</sup> Conference Call on IRIS Integral Testing**

Participants:

F. Bianchi (ENEA) D. Grgic (FER) J. Carbajo, G. Yoder (ORNL) D. Papini (POLIMI) C. Congiu (SIET) M. Dzodzo, G. Storricks (WEC) A. Carnevali (UNIPI/WEC)
---

1. We approved the minutes of the April 3<sup>rd</sup> conference call.
2. Facility design
  - SIET is finishing the documentation conclusions for the two sensitivity analyses completed earlier.
  - Cinzia is running two additional sensitivity analyses. The first reduces the drywell volume, and the second also adds internal insulation (3mm of the 902 material Milorad identified). These will finish running next week.
  - Davor recalls running similar sensitivity cases for IRIS while we were considering going to a 22.5 m. containment. He will research what he found at that time for comparison.
  - Cinzia intends to start another run including heat structures similar to what Davor has in the latest IRIS runs. Davor will supply the necessary information.
  - SIET reiterated their concerns about manufacturing difficulties associated with insulating the inside of the drywell tank.
  - Gary emphasized that we will never have a perfect model of the condensation in the drywell. Computer modeling alone will not solve the problem or provide confidence in the test results, so it is essential that we have a way to perform sensitivity studies in the containment as part of the test program. Milorad's idea of insulating the inner surface drywell tank and then adding various metal masses inside the tank is one way to accomplish this.
3. IRIS transient analyses
  - Davor is running a case with the new RWST/EHRS model and the latest containment model. He will document it over the weekend and send the results early next week.
  - Davide intends to use the new RELAP5 EHRS condensation heat transfer model for SPES-3 runs, and asked if Davor could do the validation. Davor believes that it should work (he is already using it for IRIS analyses). Davor will provide documentation
  - Davide had doubts about the containment condensation correlation; specifically, why Uchida? Davor replied that the Uchida correlation is licensed and recommended by the USNRC.
  - Davide will provide a preliminary report on his analyses tomorrow. Gary asked that it be placed in the eRoom (marked "Preliminary").
4. Scaling Analysis
  - Alessandro Carnevali started working at Westinghouse this week. He is researching insulation options (see attachment in file "IRIS\_SPES3\_Conf Call Minutes #97 Att 1 INSULATION.xls").



5. The next conference call will be on Friday, April 24<sup>th</sup>, 2009 at 9:00 a.m. US time, 3:00 p.m. EU time.



**2009 April 24<sup>th</sup>**  
**98<sup>th</sup> Conference Call on IRIS Integral Testing**

Participants:

F. Bianchi (ENEA) D. Grgic (FER) J. Carbajo, G. Yoder (ORNL) C. Congiu, R. Ferri (SIET) M. Dzodzo, G. Storrack (WEC) A. Carnevali (UNIPI/WEC)
--

1. We approved the minutes of the April 17<sup>th</sup> conference call.
2. Facility design
  - SIET completed the documentation for the two sensitivity analyses and sent it to ENEA.
  - SIET restarted the two additional sensitivity analyses mentioned in last week's call. The first reduces the drywell volume, and the second also adds internal insulation (3mm of the 902 material Milorad identified). These will finish running in about 10 days.
  - Davide gave SIET a modified version of RELAP5 (L4) containing revised condensation correlations. Earlier this week, Fosco authorized running a case to compare this with the PERSEO data. Davor thought that the L5 version may be more appropriate; he will confirm and then provide a copy to SIET, if necessary.
  - Roberta recommended that Milorad and Alessandro use the latest cases (currently running) for future Fractional Scaling Analyses. SIET will transfer the results to Westinghouse when they are available.
  - Gary emphasized that we will never have a perfect model of the condensation in the drywell. Computer modeling alone will not solve the problem or provide confidence in the test results, so it is essential that we have a way to perform sensitivity studies in the containment as part of the test program. Milorad's idea of insulating the inner surface drywell tank and then adding various metal masses inside the tank is one way to accomplish this.
3. IRIS transient analyses
  - No major changes. Davor is post-processing earlier results and reviewing Davide's results.
4. Scaling Analysis
  - Westinghouse is archiving the files left by Donato, Gaetano and Simone.
  - Alessandro continued researching drywell insulation options.
5. Schedules
  - Gary will update the schedule after he call to incorporate information just received from FOscI.
6. The next conference call will be on Thursday, April 30<sup>th</sup>, 2009 at 9:00 a.m. US time, 3:00 p.m. EU time. **NOTE THE CHANGE IN DAY (due to the European Holiday on Friday).**



## ANNEX II – MODIFICATION OF RELAP5 WITH REVISED CONDENSATION CORRELATIONS

*In this Appendix, a further Action followed-up by POLIMI is briefly introduced.*

*As mentioned in some of the presented above Conf Calls Minutes, a new set of heat transfer correlations for condensation of water steam inside a vertical tube was implemented within the version RELAP5/MOD3.3 of the code. The heat transfer subroutine CONDEN was modified with call to more accurate condensation correlations, based on the physics of film condensation theory, adapted from a vertical plate to the inside of a vertical pipe.*

*The work has been already described in a previous Report (CERSE-POLIMI RL-1121/2008). It is just summarized that old calculational mode based on maximum between Nusselt and Shah correlations was substituted by: Nusselt correlation (laminar regime), Kutateladze correlation (laminar wavy regime) and Chen correlation (turbulent regime), with corresponding selection logic added to the subroutine.*

During the first months of 2009, the preliminary validation activity on the modified version of RELAP5/MOD3.3 (two versions are indeed available, respectively -L4 and -L5) continued working directly on the RELAP model of the IRIS reactor EHRS.

A stand-alone model of the EHRS, involving steam line (before condenser), the condenser (vertical tube heat exchanger – HX – submerged in RWST pool), and feed line (after condenser), was developed and used for testing of the modified code version. In particular when simulating the system in PERSEO facility conditions (considering condensation of saturated steam at 7 MPa), the results (in terms of HTC distribution and prediction of exchanged power) were highly promising.

The developed nodalization of the EHRS is depicted in Figure A-1, whereas the comparison between the results of OLD RELAP version and NEW RELAP version is shown in Figure A-2 (condensation HTC trend along vertical tube abscissa) and Figure A-3 (thermal power exchanged to the pool). The HTC is no more underestimated, and the real HX power is caught without any tuning action (neither fouling factor, nor heated equivalent diameter modification).

If the modified version of RELAP5 would like to be "officially" used for IRIS safety analyses, or apply for RELAP5 code developers (e.g., CAMP Meeting), the provided validation activity proves indeed to be too much preliminary. Utilization of a qualified RELAP5 nodalization (as the one of the whole SPES3 facility, or of the PERSEO facility analysed in the past) is therefore mandatory. This last Action, already authorized as confirmed above (Conf Call Minute of April 24, 2009), is however still on hold.

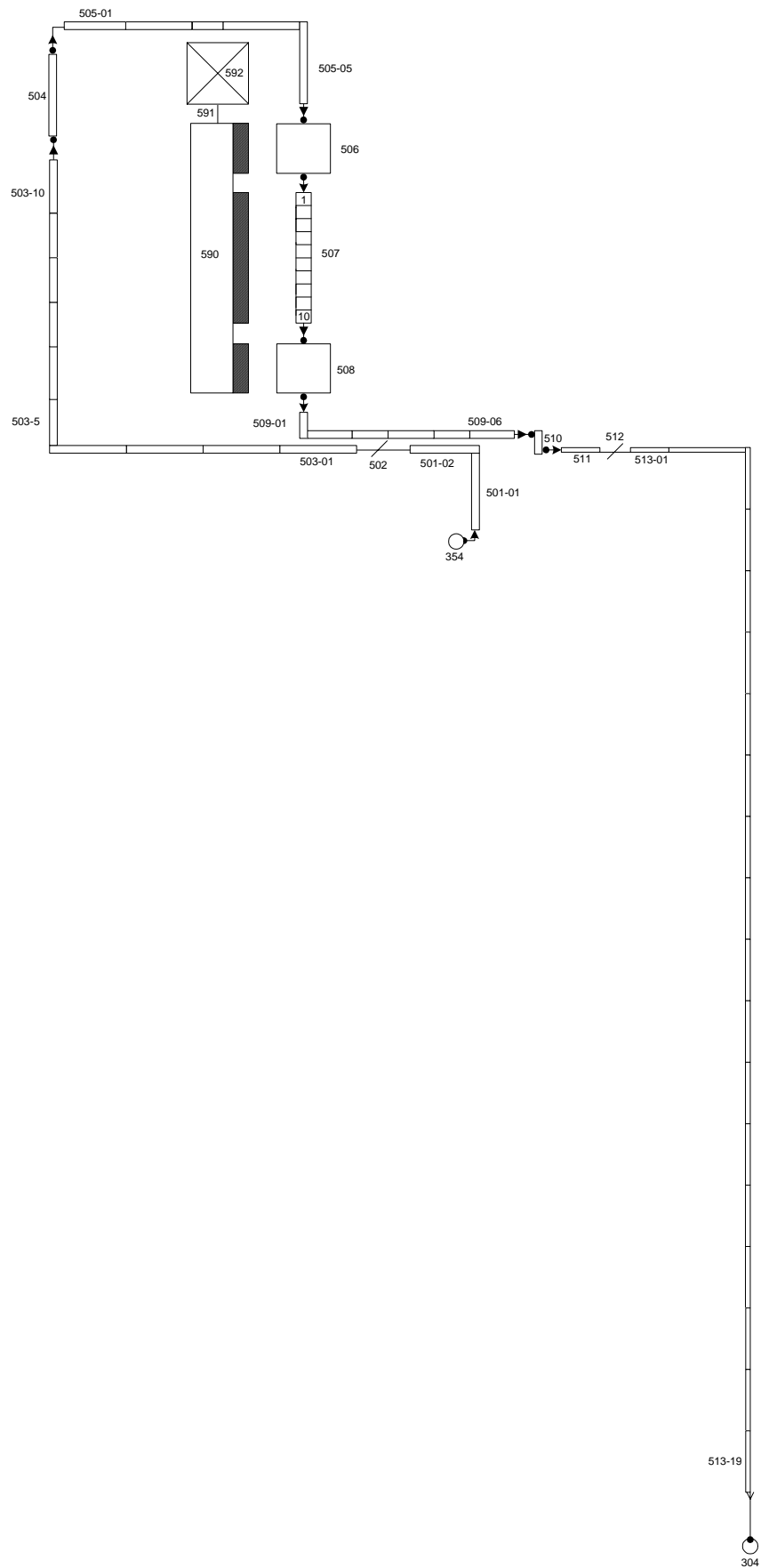

Figure A-1 - RELAP5 stand-alone model of EHR5 used in testing.

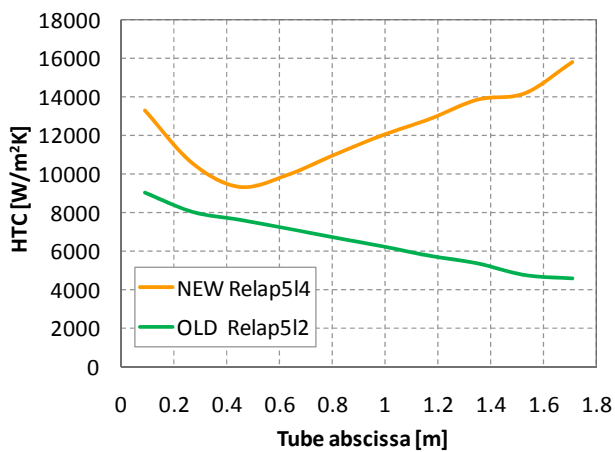

Figure A-2 – Comparison between OLD version (Relap5L2) and NEW version (Relap5L4) in terms of HTC distribution along tube abscissa.

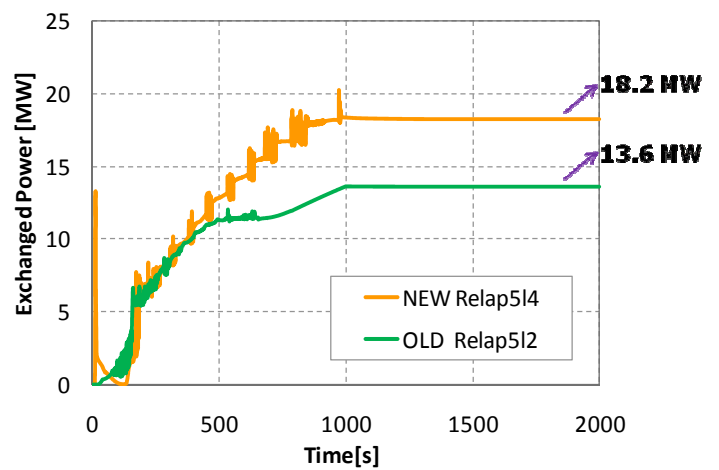

Figure A-3 - Comparison between OLD version (Relap5L2) and NEW version (Relap5L4) in terms of exchanged thermal power.



At the end, the modified subroutine CONDEN as it has been compiled within the modified version RELAP5L5 is reported in the followings.

```
*define win32cvf
*define erf
*define fourbyt
*define hconden
*define impron
*define in32
*define newnrc
*define ploc
*define sphaccm
*define unix
*define loadhi
*define noselap
*define noextvol
*define noextv20
*define noextsys
*define noextjun
*define noextj20
*define noparcs
*define nonanscr
*define nonpa
*define nomap
*define bigfa
*define logp
*deck conden
    subroutine conden
c
c $Id: conden.ff 305 2004-07-30 15:43:09Z dbarber $
c
c Condensation heat transfer correlations.
c
c Cognizant engineer: rjw.
c
    implicit none
    include 'contrl.h'
    include 'fast.h'
    include 'htrcom.h'
    include 'stcblk.h'
    include 'stcom.h'
    include 'ufiles.h'
    include 'voldat.h'
c
    real*8 alo,alp,diff,dtliq,dtppts,dtvap,f1,f2,fr,
    & hinter,hshah,ht1,ht2,htcfdb,quax,reyg,twsub,xmg,z
    real*8 direct,filmr,refilm,hdb,hf,hnu,qqfodb,retr,hnd
    integer htoptasave
    real*8 relaxhtc, newhtc
    external dittus
    parameter (gc=9.80665)
c
    hinter(alo,ht1,ht2,alp,diff) = ht1 + (ht2 - ht1)*(alp - alo)*diff
c
c Condensation heat transfer.
    if (help .ne. 0) then
cblh-----
cblh    if (iand(ihlppr(1),ishft(1,4)).ne.0) then
```



```
cbhl-----
cbhl   if( iand(vctrlx(iv),1).ne.0 ) then
      if(isprntconden4) then
cbhl-----
      if(isdbgprntflg0(1,iv)) then
cbhl-----
        write (output,50) hfg,rhof(iv),rhog(iv),
          & thconf(iv),thcong(iv),viscf(iv),viscg(iv),csubpf(iv),csubpg(iv),
          & tempg(iv),tempf(iv),hydzc(iv2) + hydzc(iv2+1),dl(iv1)
50 format (5x,'conden - hfg',11x,'rhof',10x,'rhog',10x,'thconf',8x,
          & 'thcong',8x,'viscf',9x,'viscg',9x,'csubpf',12x,1p,8e14.6/
          & 14x,'csubpg',8x,'tempg',9x,'tempf',9x,'elev.chng.',6x,'dl'/
          & 12x,5e14.6)
        endif
      endif
      endif
c
c   force reset of incnd to 0.
incnd = 0
htcg = 0.0d0
dtpgs = tw - satt(iv)
dtliq = tw - tempf(iv)
c
c Try to smooth transitions from condensation to other modes.
if (voidg(iv) .le. 0.3d0.or. irwt .gt. 0
& .or. dtliq .gt. 0.0d0) then
c Forced convection to liquid.
rhos = rhof(iv)
tf = tempf(iv)
thcons = thconf(iv)
viscs = viscf(iv)
cps = csubpf(iv)
beta = betaff(iv)
mode = 2
c reset htopta temporarily to 1 when it is 15
htoptasave = htopta
if (htopta .eq. 15) then
  htopta = 1
endif
c
call dittus
htopta = htoptasave
qfgo = 0.0d0
c Save the Dittus-Boelter values for liquid.
htcfdb = htcf
qffodb = qfluxo
else
  htcfdb = 0.d0
  qffodb = 0.d0
endif
if (abs(delgrv) .lt. 0.001d0) then
c Laminar film condensation
c Horizontal stratified condensation heat transfer.
twsub = -dtpgs
hcond = .296d0*((rhof(iv)*max((rhof(iv) - rhog(iv)),0.0d0)*gravcn
&*
& hfg*thconf(iv)**3)/(htdiam*viscf(iv)*(max(1.d0,twsub))))** .25d0
else
c Condensation on a vertical pipe or plate.
```



```
c Base it on film thickness to make it a local form
c instead of the average value used in MOD3 up to 3.1.1.1
c Local Form of Nusselt for Vertical Surfaces.
c - calculate film thickness from film Re.
c - direct is the direction cosine for the gravity vector.
c - it is assumed that a slanted surface is facing up.
c
  direct = abs(delgrv/dl(iv1))
c
  refilm = abs(gliqa) * htdiam / viscf(iv)
  filmt = 0.9086d0* (refilm * (viscf(iv)/rhof(iv))**2
&      / direct)**0.33333d0
c
c - limit film thickness : > 10 microns.
c
  filmt = max(1.0d-05,filmt)
c
c - compute Nusselt HTC.
c
  hcond = thconf(iv) / filmt
c
c - do not allow the HTC to be less than that for laminar flow.
c
  hcond = max(hcond,4.36d0*thconf(iv)/htdiam)
endif
hnuss = hcond
c
c check flag for using default condensation correlation package
c laminar .. Nusselt
c turbulent .. Shah
c non-condensibile .. Colburn-Hougen
c
  if (htopta .ne. 53) go to 500
c
c Alternative model is Nusselt-UCB.
c Vierow-Shrock UC Berkley. Int Conf on Multiphase Flows 1991, Tsukuba,
c Sept 24-27, 1991.
c First get a Reynolds number based on film thickness. Do not let the
c thickness be zero when voidg is 1. or the condensation startup
c transient will be wrong. R5 hydro does not realize that the water is
c sticking to the wall.
c F1 has the gas velocity effect and f2 has the noncondensibile.
c Professor Schrock reported to Gary Johnsen in 1992 that the
c multiplier for the effect of gas flow should not exceed 2. or the
c Toshiba data would be over predicted.
c The Reynolds number is based on the mixture mass flux and viscosity.
c
  reyg = ggasa*htdiam/viscg(iv)
  f1 = min(2.0d0, 1.0d0+ 2.88d-5*reyg**1.18d0)
  hcond = hcond*f1
c
200 f2 = 1.0d0
c The presence of a non-condensibile can reduce condensation.
  if (quala(iv) .gt. 1.0d-9 ) then
c Calculate the amount of reduction from the UCB work also.
c
  if (quala(iv) .lt. .063d0) then
    f2 = 1.0d0- 10.d0*quala(iv)
  elseif (quala(iv) .gt. 0.6d0) then
```



```
f2 = 1.0d0- quala(iv)**0.22d0
else
  f2 = 1.0d0- 0.938d0*quala(iv)**0.13d0
endif
endif
hcond = hcond*f2
c
  go to 600
500 continue
c
  if (quala(iv) .lt. 0.001d0) then
    if (abs(delgrv) .lt. 0.001d0) then
c Horizontal pipe condensation --> Turbulent ... Shah correlation.
      quax = max(min(quala(iv), 1.0d0),1.0d-9)
      rey = min(4000.0d0,gabs)*htdiam/viscf(iv)
c The upper mass flux limit of the Shah correlation verified range
c is 4000. See section 506.3 page 9 Sept 1990 Genium Publishing HT.
      pr = viscf(iv)*csubpf(iv)/thconf(iv)
      hdb = 0.023d0*thconf(iv)*rey**0.8d0*pr**0.4d0/htdiam
      hf = hdb*(1.0d0- quax)**0.8d0
      z = (p(iv)/pcrit)**0.4d0*(1.0d0/quax - 1.0d0)**0.8d0
      ftr = 1.0d0
      if (z.ne.0.0d0) ftr = 1.0d0+ 3.8d0/z**0.95d0
      hshah = hf*ftr
      hcond = max(hcond, hshah)
    else
c
c Vertical pipe condensation --> Film condensation theory
c Model implemented by Grgic-Papini FER-POLIMI.
c Proc. of the 7th International Conference on Nuclear Option in
c Countries with Small and Medium Electricity Grids, Dubrovnik,
c May 25-29, 2008.
c Correlations valid for laminar wavy and turbulent regime inside a
c vertical tube, replacing Shah correlation and selected according to
c condensate Reynolds number (film Re).
c
      direct = abs(delgrv/dl(iv1))
c
      pr = viscf(iv)*csubpf(iv)/thconf(iv)
      retr = 4658.d0*pr**(-1.05)
      if (refilm .le. 30.d0) then
c do nothing --> heat transfer coefficient is the one already calculated
c for laminar film condensation on a vertical surface (Nusselt corr.)
        elseif (refilm .le. retr) then
c laminar wavy regime: Kutateladze correlation
          hnd = 0.756d0*refilm**(-0.22)
          hcond = hnd*thconf(iv)*(viscf(iv)**2/
&          (rhof(iv)*(rhof(iv)-rhog(iv))*gc)**(-1.0/3.0)
        else
c turbulent regime: Chen correlation
          hnd = 0.00402d0*refilm**0.4*pr**0.65
          hcond = hnd*thconf(iv)*(viscf(iv)**2/
&          (rhof(iv)*(rhof(iv)-rhog(iv))*gc)**(-1.0/3.0)
        endif
      endif
    endif
  endif
c
  if (quala(iv) .lt. 0.0001d0) then
c do nothing
```



```
elseif (quala(iv) .gt. 0.001d0) then
  call noncnd
  qfgo = 0.0d0
  z = qfluxo/hcond
  hcond = hcond*z/dtpps
crelax   htcf = hcond
  newhtc = hcond
  htcf = relaxhtc (oldhtcf, newhtc)
c Noncnd returns qfluxo and hcond but delta-temp must be solved for
  else
  hshah = hcond
  call noncnd
  xmg = (0.001d0- quala(iv))*1111.1111d0
c 1111.1111=1/0.0009=(0.001-0.0001)
  z = qfluxo/hcond
  hcond = hcond*z/dtpps
  hcond = hshah*xmg + hcond*(1.0d0- xmg)
  endif
600 continue
  if (dtliq .lt. 0.d0) then
c Normal condensation
  qfluxo = hcond*dtpps
  qffo = hcond*dtliq
  qffo = max(qffo,qfluxo)
  qfgo = qfluxo - qffo
  qfgo = min(qfgo, 0.0d0)
crelax   htcg = qfgo/dtpps
  newhtc = qfgo/dtpps
  htcg = relaxhtc (oldhtcg, newhtc)
crelax   htcf = hcond
  newhtc = hcond
  htcf = relaxhtc (oldhtcf, newhtc)
  else
c Abnormal condensation
c htcfdb was relaxed in dittus
  htcf = htcfdb
  qffo = htcf*dtliq
crelax   htcg = hcond
  newhtc = hcond
  htcg = relaxhtc (oldhtcg, newhtc)
  qfgo = hcond*dtpps
  endif
c
c Weight heat flux by degree of stratification and water level
c assume no bubbles are breaking the surface in condensation mode
c and complete stratification exists.
c Heat flux discontinuities may occur when strat begins or ends.
  if (irwt .gt. 0) then
  xmg = voidg(iv)
  if (dlev(iv) .gt. 0.0d0) xmg = 1.0d0- dlev(iv)/dl(iv)
crelax   htcf = hcond*xmg
  newhtc = hcond*xmg
  htcf = relaxhtc (oldhtcf, newhtc)
  htcfdb = htcfdb*(1.0d0- xmg)
c htcfdb was relaxed in dittus
  htcf = htcfdb
  qfgo = htcf*dtpps
  qffo = htcf*(tw - tempf(iv))
  if (tempf(iv).lt.satt(iv) .and. voidg(iv).gt.0.95d0) then
```



```
c Ramp energy taken from liquid to zero as liquid disappears.
c 1./(.999 - .95) = 1/0.049 = 20.40816
c htcf was relaxed above
  htcf = hinter(voidg(iv),0.0d0,htcf,.999d0,20.40816d0)
  qffo = htcf*(tw - tempf(iv))
endif
endif
if (voidg(iv) .lt. 0.3d0) then
c Htrc1 sends the code to dittus mode 2 if voidg is less than .1.
c Interpolate between voidg - .3 and .1.
c 1./(.3 - .1) = 5.0
c htcfdb was relaxed in dittus, htcf was relaxed above
  htcf = hinter(0.1d0,htcfdb,htcf,voidg(iv),5.0d0)
c htcg was relaxed above
  htcg = hinter(0.1d0,0.0d0,htcg,voidg(iv),5.0d0)
  qffo = htcf*dtliq
  qfgo = htcg*dtpps
endif
if (voidg(iv) .lt. 1.d0) then
  mode = 10
else
  mode = 11
endif
999 continue
qfluxo = qfgo + qffo
htcoef = htcg + htcf
htzhgg = 0.0d0
htzhgp = htcg
htzht = htcoef
htzhff = htcf
htzhft = 0.0d0
htzhgt = 0.0d0
htqot = qfluxo
htqof = qffo
htqog = qfgo
htgamf = 0.0d0
htgamg = htsa*recipv(iv)/max((hsteam(iv) - sathf(iv)),1.d4)
gamw = htgamg*qfgo
c The low value of 1.e4 was chosen based on Helium.
if (help .ne. 0) then
cblh-----
cblh   if (iand(ihlppr(1),ishft(1,4)) .ne. 0) then
cblh-----
cblh   if (iand(vctrlx(iv),1) .ne. 0) then
  if(isprntconden4) then
cblh-----
  if(isdbgprntflg0(1,iv)) then
cblh-----
    if( htopta.eq.53 ) then
      write (output,1100) htcoef,qfluxo,gamw,hcond,f1,f2
    else
      if (abs(delgrv) .gt. 0.001d0) then
        if (quala(iv) .lt. 0.001d0) then
          write (output,1101) qfluxo,qfgo,qffo,gamw,filmf
&          ,rey,hshah,fr
        else
          write (output,1104) qfluxo,qfgo,qffo,gamw,filmf
&          ,refilm
        endif
      endif
    endif
  endif
endif
```



```

endif
endif
write (output,1102) hcond,htcoef,htcg,htcf,hnuss,htcfdb
dtvap = tw - tempg(iv)
write (output,1103) dtpps,dtliq,dtvap,gabs,gliqa
&
,ggasa
1100 format (5x,'conden - htcoef',8x,'qfluxo',8x,'gamw',10x,'hcond',
& 9x,'f1',12x,'f2',/12x,1p,6e14.6)
1101 format (5x,'conden - qfluxo',8x,'qfgo',10x,'qffo',6x,'gamw',
& 8x,'filmt',8x,'rey',9x,'hshah',6x,'ftr',/12x,1p,8g12.3)
1104 format (5x,'conden - qfluxo',8x,'qfgo',10x,'qffo',6x,'gamw',
& 8x,'filmt',8x,'refilm',/12x,1p,6g12.3)
1102 format (14x,'hcond',9x,' htcoef',8x,'htcg',10x,'htcf',9x,'hnuss'
& ,10x,'htcfdb',/12x,1p,6e14.6)
1103 format (14x,'dtpps',8x,' dtliq',5x,'dtvap',8x,
& 'gabs',8x,'gliqa',7x,'ggasa',/12x,1p,6g12.3)
endif
endif
return
end
c*****
c
c Data dictionary for local variables
c
c Number of local variables = 26
c
c i=integer r=real l=logical c=character
c*****
c Type Name Definition
c-----
c r alo =
c r alp =
c r diff =
c r direct =
c r dtliq =
c r dtpps =
c r dtvap =
c r f1 =
c r f2 =
c r filmt =
c r ftr =
c r hdb =
c r hf =
c r hinter =
c r hnuss =
c r hshah =
c r ht1 =
c r ht2 =
c r htcfdb =
c r qffodb =
c r quax =
c r refilm =
c r reyg =
c r twsub =
c r xmg =
c r z =
c*****

```