



Agenzia Nazionale per le Nuove Tecnologie,  
l'Energia e lo Sviluppo Economico Sostenibile



*Ministero dello Sviluppo Economico*

## RICERCA DI SISTEMA ELETTRICO

Rapporto su analisi di impianti dotati di sistemi di sicurezza passivi

*Oswaldo Aronica*

## RAPPORTO SU ANALISI DI IMPIANTI DOTATI DI SISTEMI DI SICUREZZA PASSIVI

Osvaldo Aronica (ENEA)

Novembre 2011

Report Ricerca di Sistema Elettrico

Accordo di Programma Ministero dello Sviluppo Economico – ENEA

Area: Governo, gestione e sviluppo del sistema elettrico nazionale

Progetto: Fissione nucleare: metodi di analisi e verifica di progetti nucleari di generazione evolutiva ad acqua pressurizzata

Responsabile Progetto: Massimo Sepielli, ENEA

**Titolo**

**Rapporto su analisi di impianti dotati di sistemi di sicurezza passivi**

**Descrittori**

**Tipologia del documento:** Rapporto tecnico

**Collocazione contrattuale:** ACCORDO DI PROGRAMMA Ministero dello Sviluppo Economico – ENEA sulla Ricerca di Sistema Elettrico PIANO ANNUALE DI REALIZZAZIONE 2010 Progetto 1.3.2.a: Fissione nucleare: Metodi di analisi e verifica di progetti nucleari di generazione evolutiva ad acqua pressurizzata.

**Argomenti trattati:** Fisica dei reattori nucleari, Metodi Montecarlo, Tecnologia dei reattori nucleari

**Sommario**

Nel presente rapporto sono stati inclusi due studi: l'uno riguardante il comportamento di un reattore di Generation III+, dotato di sistemi d'impianto passivi, a un evento tipo Fukushima e l'altro riguardante l'affidabilità di misuratori "Self-Powered" di flusso neutronico in-core.

**Note**
**Copia n.**
**In carico a:**

2			NOME			
			FIRMA			
1			NOME			
			FIRMA			
0	EMISSIONE	30.11.2011	NOME	G. Aronica	P.C. Incalcaterra	M. Sepielli
			FIRMA			
REV.	DESCRIZIONE	DATA		REDAZIONE	CONVALIDA	APPROVAZIONE

 <b>Ricerca Sistema Elettrico</b>	<b>Sigla di identificazione</b>	<b>Rev.</b>	<b>Distrib.</b>	<b>Pag.</b>	<b>di</b>
	PAR2010-CIRTEN-LA2-019	0	L	2	3

## Indice

1.Introduzione Pag. 3

### Indice degli allegati

Allegato 1 Pag. 4  
*Generation III+ Reactor response to Fukushima-like scenario (di pagg.32)*

Allegato 2 Pag. 5  
*Analisi di affidabilità dei misuratori di flusso neutronico in-core ( di pagg.18)*

 <b>Ricerca Sistema Elettrico</b>	<b>Sigla di identificazione</b>	<b>Rev.</b>	<b>Distrib.</b>	<b>Pag.</b>	<b>di</b>
	PAR2010-CIRTEN-LA2-019	0	L	3	3

## 1. Introduzione

Nel presente rapporto sono stati inclusi due studi: l'uno riguardante il comportamento di un reattore di Generation III+, dotato di sistemi d'impianto passivi, a un evento tipo Fukushima e l'altro riguardante l'affidabilità di misuratori "Self-Powered" di flusso neutronico in-core.

L'impianto di riferimento considerato nel primo studio è un reattore AP1000, mentre lo scenario d'incidente preso a riferimento, seguendo le indicazioni date dalla ENSREG (European Nuclear Safety Regulator Group) per i "stress test" è il terremoto in concomitanza con un allagamento. Le condizioni assunte per l'impianto sono state: *station black-out*, cioè perdita di alimentazione elettrica alternata, o *total station black-out*, cioè perdita di alimentazione elettrica alternata e perdita della batterie di alimentazione d'emergenza. Nel peggiore dei due casi la probabilità di *core damage* condotta secondo una Probabilistic Risk Assessment è stato stimato  $2.39E-6$ . Tale valore è dovuto alle caratteristiche dei sistemi di sicurezza passiva dell'AP1000 contenuti all'interno del contenitore.

Risulta di particolare importanza il ruolo che svolge il sistema PRHR (Passive Residual Heat Removal), cioè il sistema passivo di rimozione del calore residuo. Anche nel caso di fallimento del sistema PRHR, nel reattore AP1000 il sistema ADS (Automatic Depressurization System), cioè il sistema di depressurizzazione automatico sarebbe ancora disponibile mediante azionamento manuale (*squib controller cabinet*) localizzato in un'area protetta dall'allagamento e con alimentazione indipendente fornita da batterie.

Nel secondo studio è stata condotta una analisi di affidabilità, tramite tecniche di Montecarlo, dei Self-Powered Neutron Detectors (SPNDs), utilizzati per la misurazione del flusso neutronico all'interno del nocciolo del reattore European Pressurized Reactor (EPR). L'analisi di affidabilità è stata condotta sull'ipotesi che il rateo di guasto dei rivelatori segua una funzione di distribuzione di probabilità di tipo gaussiana e che la valutazione dell'errore della misurazione possa essere ottenuta come conseguenza di una variazione localizzata del flusso neutronico.

**Titolo**
**Generation III+ Reactor response to Fukushima-like scenario**
**Ente emittente** CIRTEN POLI MI

# PAGINA DI GUARDIA

**Descrittori**
**Tipologia del documento:** Rapporto tecnico

**Collocazione contrattuale:** ACCORDO DI PROGRAMMA Ministero dello Sviluppo Economico – ENEA sulla Ricerca di Sistema Elettrico PIANO ANNUALE DI REALIZZAZIONE 2010 Progetto 1.3.2.a: Fissione nucleare: Metodi di analisi e verifica di progetti nucleari di generazione evolutiva ad acqua pressurizzata.

**Argomenti trattati:** Tecnologia dei reattori nucleari

**Sommario**

*This document presents the response of a reference generation III+ reactor to a Fukushima-like accident. The Reference plant considered in the analysis is the generation III+ AP1000. The accident scenario considered follows the indication of ENSREG's "stress tests" specifications. In particular an earthquake concurrent with A flooding event is postulated, assuming the reactor in:*

**station black--out (SBO: loss of all AC electrical power supply) or**

**total station black--out characterized by SBO and loss of DC batteries (total SBO)**

**Note**
**Copia n.**
**In carico a:**

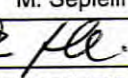
2			NOME			
			FIRMA			
1			NOME			
			FIRMA			
0	EMISSIONE	30/11/2011	NOME	O. Aronica	P.C. Incalcaterra	M. Sepielli
			FIRMA			
REV.	DESCRIZIONE	DATA	CONVALIDA	VISTO	APPROVAZIONE	



**CIRTEN**

**Consorzio Interuniversitario per la Ricerca Tecnologica Nucleare**

**POLITECNICO DI MILANO**

**^DIPARTIMENTO DI ENERGIA, Sezione INGEGNERIA NUCLEARE-CeSNEF**

# **Generation III+ Reactor response to Fukushima-like scenario**

**Shan Yameng<sup>^</sup>, Marco Ricotti<sup>^</sup>**

**CERSE-POLIMI RL-1460/2011**

**Milano, Novembre 2011**

*Lavoro svolto in esecuzione dell'Obiettivo 1.1 – Attività A.2  
“Studio probabilistico di eventi iniziatori che portano a condizioni incidentali di tipo severo”  
AdP MSE - ENEA “Ricerca di Sistema Elettrico” - PAR2010  
“Nuovo Nucleare da Fissione”.*



## INDEX

Executive Summary.....	3
List of Acronyms and Abbreviations .....	4
1 Fukushima Accident .....	5
2 Lessons Learned .....	8
2.1 Beyond Design Accidents due to external hazards .....	11
2.2 Spent Fuel Pool Management.....	12
3 ENSREG "stress tests" .....	14
3.1 Station Blackout .....	15
4 AP1000: passive safety systems .....	16
4.1 Passive Core Cooling System.....	16
4.2 Passive Containment Cooling System .....	19
5 AP1000 response to Station Blackout .....	21
5.1 Station Blackout's PRA .....	27
5.2 Systems, Structures and Components important for safety of reactor .....	27
6 Conclusion and considerations.....	30
Event trees .....	32



## Executive Summary

This document presents the response of a reference generation III+ reactor to a Fukushima-like accident. The reference plant considered in the analysis is the generation III+ AP1000.

The accident scenario considered follows the indication of ENSREG's "stress tests" specifications. In particular an earthquake concurrent with a flooding event is postulated, assuming the reactor in:

- **station black-out** (SBO: loss of all AC electrical power supply) or
- **total station black-out** characterized by SBO and loss of DC batteries (total SBO)<sup>1</sup>.

Based on the AP1000 PRA, the probability<sup>2</sup> of core damage given the most severe case of total SBO is in the range of  $10^{-6}$ - $10^{-5}$  (estimated  $2.39E-6$ ). This is due to the passive safety features of AP1000, which are inside the containment vessel. In particular the role of the PRHR is crucial to reach such results. Even in case of PRHR failure, AP1000 full ADS depressurization is still available due to manual actuation from DAS squib controller cabinet, which relies on own batteries, located in a flooding protected area.

The results in terms of conditional probability of high-pressure core damage (HCD) are shown below:

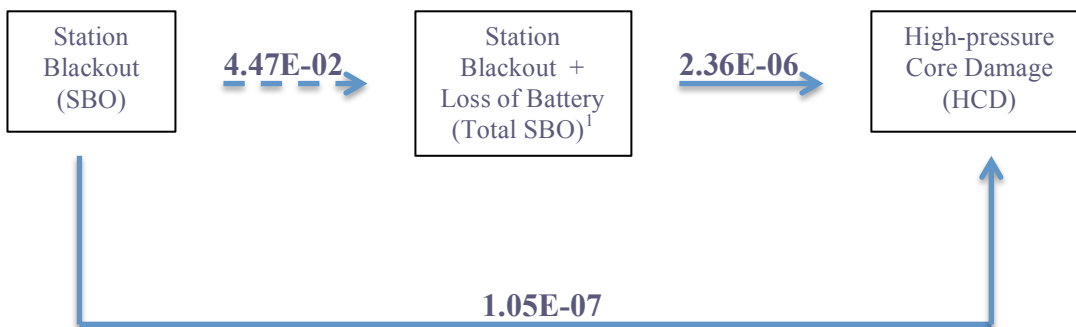

In the two scenarios the system components essential for plant safety are: PRHR HX, class 1E battery and DAS squib valve controller cabinet and instrument cabinet.

The work has been developed in joint cooperation with Corrado Alessandrini, Maurizio Bruzzone and Gianfranco Saiu of Ansaldo Nucleare.

1. The DAS squib valve controller cabinet and instrument cabinet's batteries supply is assumed to be available because located in a flooding protected area.

2. Conditional probability



## List of Acronyms and Abbreviations

AC	Alternate Current
ACC	Accumulator
ADS	Automatic Depressurization System
AOV	Air Operated Valve
CMT	Core Makeup Tank
DAS	Diverse Alternative System
DID	Defense In Depth
IRWST	In-containment Refueling Water Storage Tank
MOV	Motor Operated Valve
NRC	U.S. Nuclear regulatory Commission
PCCWST	Passive Containment Cooling Water Storage Tank
PCS	Passive Containment Cooling System
PMS	Protection and Safety Monitoring System
PRHR	Passive Residual Heat Removal
PRHR HX	Passive Residual Heat Removal Heat Exchanger
PXS	Passive Core Cooling System
RNS	Normal Residual Heat Removal System
SBO	Station Black-out
SSCs	Structures Systems and Components



## 1 Fukushima Accident

On 11 March 2011, an earthquake of magnitude 9 hit the northeastern part of Japan, the “Great East Japan Earthquake” as named, together with tsunami generated have devastated local area and damaged its industry and infrastructures. More than 15000 people are dead.

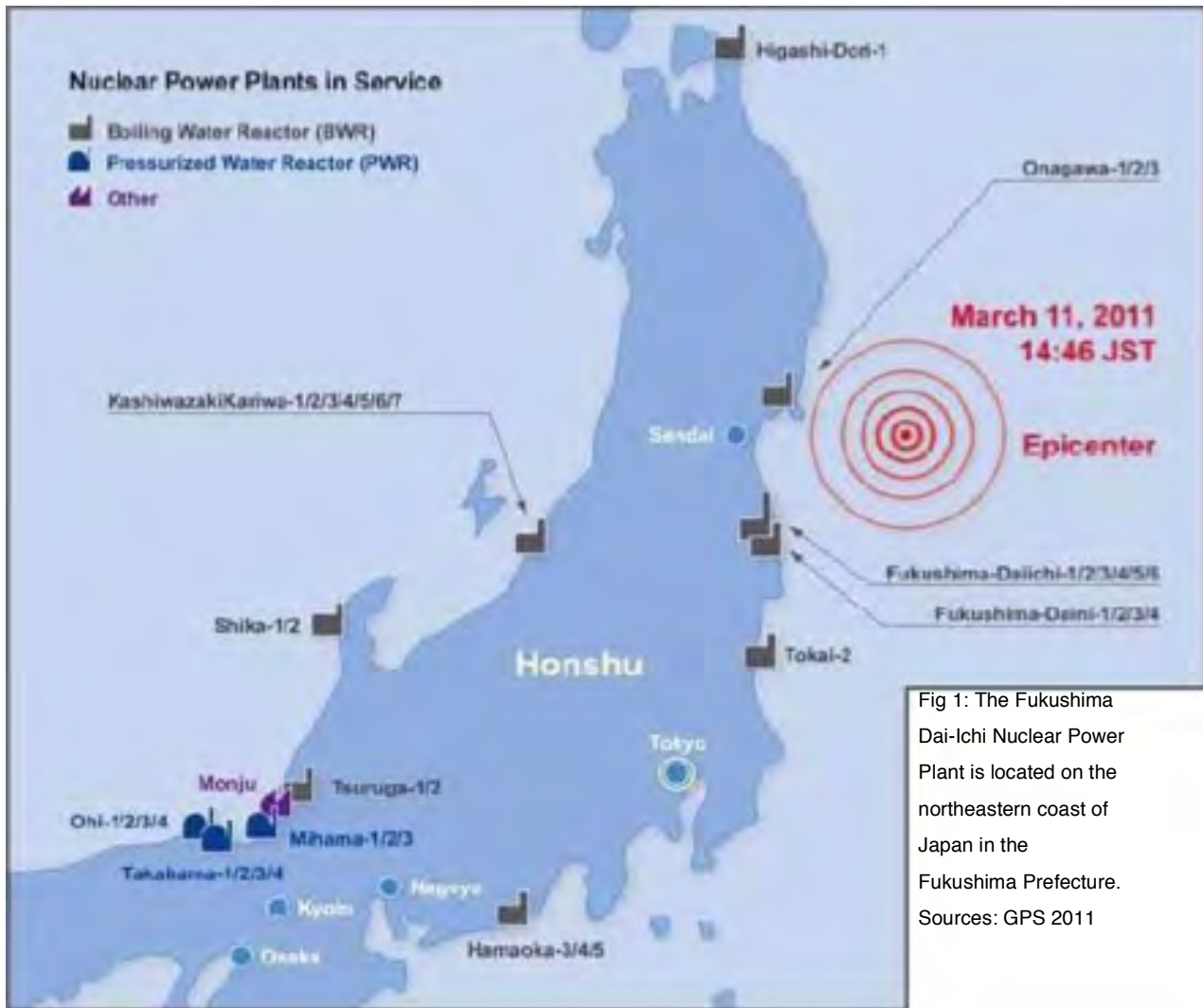

Fig 1: The Fukushima Dai-Ichi Nuclear Power Plant is located on the northeastern coast of Japan in the Fukushima Prefecture. Sources: GPS 2011

The 11 nuclear power plants (NPPs) operating at the time of the earthquake at four sites: Onagawa, Fukushima Dai-ichi and Dai-ni, and Tokai were automatically shutting down and the following tsunami damaged the NPPs in different degrees.

The worst situation was at Fukushima Dai-ichi, whose units were boiling water reactors (BWRs). There were 3 ones in operation and other 3 were shutdown for maintenance.



The loss of off-site the power (LOOP) as consequence of earthquake, activated the on-site emergency diesel generators as per procedure. The control rods were successfully inserted into the operating reactors and the site was in the normal safety shutdown situation. About 46 minutes later, the first tsunami waves hit the Dai-ichi site and the highest wave was about 14m. The Dai-ichi units were designed to resist for tsunami of 5.7 m, as result the site was flooded and the dynamic force of tsunami and big debris severely damaged its facilities and buildings, including the emergency diesels except one of unit 6. From that moment the situation at the Dai-ichi site was getting worse, without off-site and on site ac power systems and loss of batteries, it was in a total SBO state. The operators had to work in darkness and without instrumentation to assist them in ensuring plant safety; they were not prepared for such a kind of Beyond Design Basis Accident.

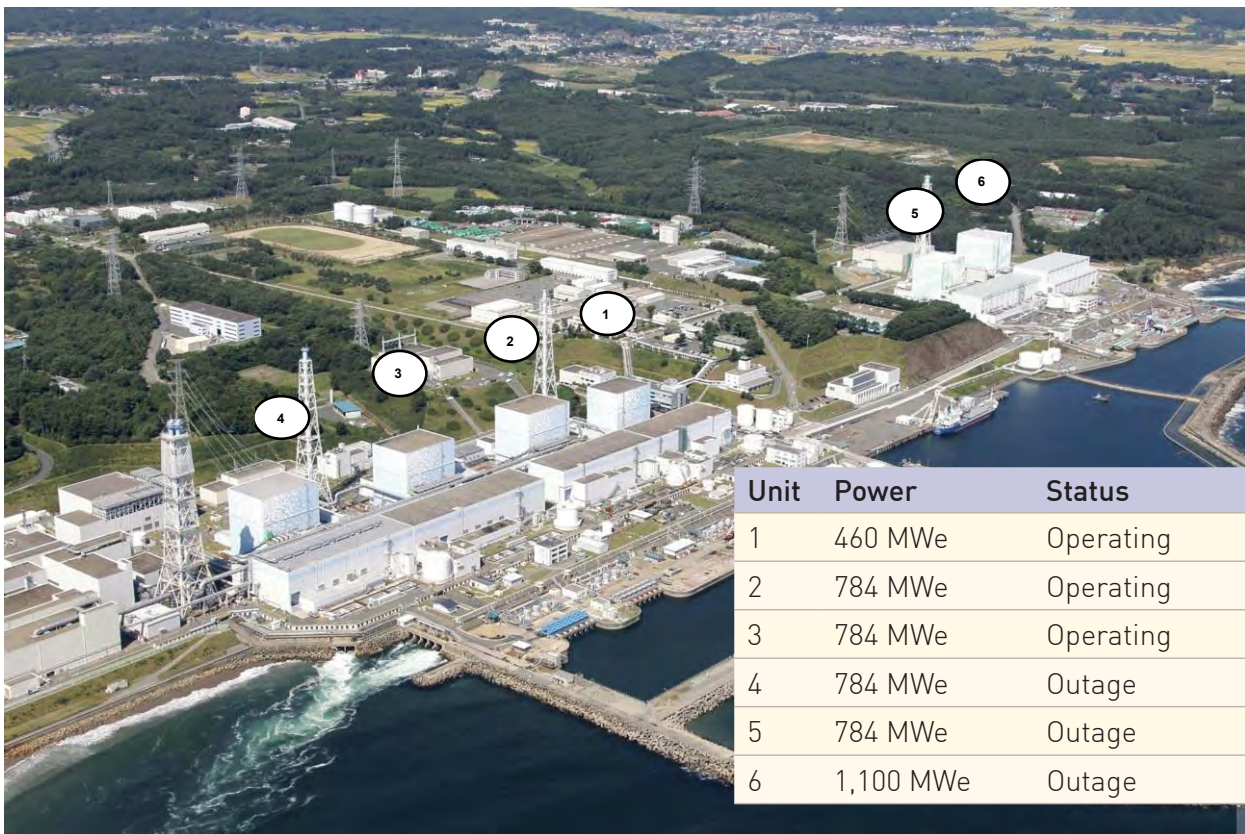

Fig 2: Fukushima Dai-Ichi NNP



## REACTORS AT THE FUKUSHIMA DAI-ICHI NUCLEAR POWER PLANT

Unit	Net MWe*	Reactor, Containment, and Cooling Systems**
1	460	BWR-3, Mark I, IC, HPCI
2	784	BWR-4, Mark I, RCIC, HPCI
3	784	BWR-4, Mark I, RCIC, HPCI
4	784	BWR-4, Mark I, RCIC, HPCI
5	784	BWR-4, Mark I, RCIC, HPCI
6	1,100	BWR-5, Mark II, RCIC, HPCS

\* MWe—megawatts electric

\*\* IC—*isolation condenser*, HPCI—*high-pressure coolant injection system*, RCIC—*reactor core isolation cooling system*, HPCS—*high-pressure core spray system*

The Cores were damaged without proper reactor residual removal heat capacity and the operators tried hardly to act the controlled vent to avoid the over-pressurization of containment. A series of explosion destroyed the reactor buildings of Unit 1, 3 and 4 due to hydrogen explosion.

Before the supply of fresh water and of off-site power became available, fire engine pump, helicopter, concrete pumping trunk, seawater intermittently borated were used to cool down the reactors and the spent fuel pools (SFPs) and to mitigate the release of fission product in surrounding environment, especially from SFPs.

The evacuation zone was extended to 20km and Japanese authorities raised the severity rating to the highest level (level 7), the same of Chernobyl disaster.



## 2 Lessons Learned

The Fukushima Accident generated in the world a new irrational feeling about use of nuclear power and its safety and the risk for human; the memory of Chernobyl is still recent. Under public opinion pressure some government decided to abandon the nuclear power option, some others delayed release of new license.

Besides these "human conclusions", task force and team of experts have been created to investigate and analyze the accident, to identify initial lessons to be learned.

As point out by the MIT's report "The lessons to be draw from the Fukushima accident are different". It should be understood that it was the worst earthquake and tsunami that Japan have been hit, which caused thousands of deaths and billions of damages, and it was so far beyond design basis accident: magnitude 9.0 mw vs. 8.2 of design, 14m high waves vs. 5.7 of design. No death was directly caused by the nuclear accident.

Although the Fukushima accident has been rated as level 7 like Chernobyl's, there are significant differences as radiation released, related deaths.

### Fukushima and Chernobyl compared

Category	Fukushima Dai-Ichi	Chernobyl
Date of accident	11 March 2011	26 April 1986
Accident details	A magnitude-9.0 earthquake and resulting tsunami damaged the plant's power systems, causing cooling systems to fail. A series of gas explosions followed	A sudden power output surge during a systems test caused a reactor vessel to rupture, leading to a series of blasts. An intense fire burned for 10 days
Severity rating	Level 7 - major accident	Level 7 - major accident



<b>Fukushima and Chernobyl compared</b>		
<b>Category</b>	<b>Fukushima Dai-Ichi</b>	<b>Chernobyl</b>
Number of reactors	Six; but only three of concern, plus pools storing spent fuel	Four; but only one reactor involved
Type of reactors	Boiling-water reactors. Japanese authorities stress that unlike at Chernobyl, the containment vessels at Fukushima remain intact. Also, unlike Chernobyl, the reactors at Fukushima do not have a combustible graphite core	Graphite-moderated boiling water reactor. The graphite made it highly combustible. The reactor also had no containment structure and nothing stopped the trajectory of radioactive materials into the air
Radiation released	370,000 terabecquerels (as of 12 April)	5.2 million terabecquerels
Area affected	Officials say areas extending more than 60km (36 miles) to the north-west of the plant and about 40km to the south-southwest have seen radiation levels exceed annual limits	Contamination of an area as far as 500 km (300 miles) from the plant, according to the UN. But animals and plants were also affected much further away
Evacuation zone	20km; 20-30km voluntary zone. Five communities beyond the existing evacuation zone have also been evacuated	30km



## Fukushima and Chernobyl compared

Category	Fukushima Dai-Ichi	Chernobyl
People evacuated	Tens of thousands	The authorities evacuated, in 1986, about 115,000 people from areas surrounding the reactor and subsequently relocated, after 1986, about 220,000 people from Belarus, the Russian Federation and Ukraine
Related deaths	No deaths so far due to radiation	A UN report places the total confirmed deaths from radiation at 64 as of 2008. Disputes continue about how many will eventually die
Long-term health damage	Not yet known, but risks to human health are thought to be low due to prompt and effective emergency actions taken by Japan authorities	Among the residents of Belarus, the Russian Federation and Ukraine, there had been up to the year 2005 more than 6,000 cases of thyroid cancer reported in children and adolescents who were exposed at the time of the accident, and more cases can be expected during the next decades
Current status	Officials say radiation leaks are continuing but at significant lower rates. The operator has established an adequate coolant injection to the damaged reactors and closed cooling circuits to remove heat from spent fuel	The damaged reactor is now encased in a concrete shell. A new containment structure is due to be completed by 2014



## Fukushima and Chernobyl compared

ponds. Recently a containment cover structure of the Unit 1 has been completed. The actions to bring and maintain the damaged plants in a stable cooling condition and limit the radioactive releases will be completed according with the ROADMAP established by plant operator TEPCO (by end of 2011 and January 2012)

### 2.1 Beyond Design Accidents due to external hazards

As the Fukushima accident was still evolving, the International Atomic Energy Agency (IAEA) with agreement of Japanese Government conducted a preliminary mission to find facts and identify initial lessons to be learned from the accident at Dai-ichi site, sharing this information across the world nuclear community. The results of the Mission have been reported to the IAEA Ministerial Conference on Nuclear Safety at IAEA headquarters in Vienna on 20-24 June 2011.

There are three major areas where are necessary looking for to improve nuclear safety: external hazards defence, severe accident management and emergency preparedness.

As reported by IAEA document, regard the external natural hazards, there should be sufficient protection against infrequent and complex combinations of these events. The flooding and its long term impacts should be carefully considered, provided a "dry site concept" where possible and physical separation and diversity of critical safety systems to increase the robustness of defence-in-depth (DID) against the risk of loss of safety



functionality. In multiple unit sites, the problem of common cause failures, multiple units failures and independent unit recovery options should not be overlooked. It requires large resource of trained experienced people, equipment, supplies and external support, as also point out by MIT report: a coordinated off-site pool of experts and workers should be created to treat each type of NPP, as likely the local staff would be injured and not able to operating in a catastrophic event like earthquake and flooding, that can be moved quickly at damaged units. There should be an active tsunami warning system with the provision for immediate operator action and the plant safety should be reviewed to any further important acknowledge on external hazards.

Emergency response centers (ERS) should be housed in a seismic resistance building , well shielded, ventilated and protected also by other external events, such as flooding. Adequate equipment and supply should be provided for radiological and welfare protection of staff in case of an accident. The vital safety related monitoring parameters (coolant levels, containment pressure etc.) should be guaranteed as long as possible and the communication lines among vary control rooms and to outside should be ensured.

An update of Severe Accident Management Guidelines (SAMG) is necessary for management of severe situation such as total loss of ac power or loss of all heat sinks or of the engineering safety systems, providing alternative, rapid response and simple devices for first days emergency recovery (mobile diesel power, compressed air, pumps, water supplies), they should be located in a safe place, also off-site (provide quickly transfer to site) and the operator trained to use them. Specific procedures should also be provided for in case of unavailability of instruments, lighting, power and abnormal conditions with high radiation.

One safety issue emerged at Fukushima is the hydrogen explosion and its consequences, particularly at spent fuel pool (SFP) location. Necessary preventing and mitigating systems should be implemented or reviewed.

## **2.2 Spent Fuel Pool Management**

As the peculiarity of nuclear power, the fuel rods still produce heat by radioactive decay after are removed from reactor and no longer used to produce electricity. Specific pool is designed to house the spent fuel rods and to keep them cool.



Generally, the SFP has an active heat removal system using off-site ac power and electric-driven pumps. Once the LOOP occurs, the system will stop to operate and the water of SFP increases its temperature and starts to boil off. A typical SFP have about 30 feet of water over the top of fuel rods and in normal condition of SFP's integrity it takes days before the rods are uncovered.

At Fukushima, the SFPs are allocated outside the primary containment of reactor, however inside the reactor building, which is the second containment, its integrity will prevent that any release of radioactive elements from SFP to atmosphere, since the pressure is kept less than atmospheric pressure, and the air is filtered before its release to outside.

During the Fukushima accident, the operators had to vent the primary containment to prevent over-pressurization, the leakage to reactor building has caused the accumulation of hydrogen and a series of explosions which have destroyed units 1-3-4's reactor buildings and damaged SFPs. A probable leakage of water from SFP due to earthquake and later damage from explosion have shortened the time before SFP uncovered and since now the SFP is directly exposed to environment, the prompt recovery of SFP is necessary to mitigate the radioactivity releases. All this worsened even more the situation. It's supposed that maybe the largest amount of release is due to SFP.

A more detailed review of SFP in case of external hazards of current and future plant should be provided.



### 3 ENSREG "stress tests"

On 24-25 March, The European Council declared that *"the safety of all EU nuclear plants should be reviewed, on the basis of a comprehensive and transparent risk assessment ("stress tests")", after what happened at Fukushima*". Moreover *"The European Nuclear Safety Regulatory Group (ENSREG) and the European Commission are invited to develop as soon as possible the scope and modalities of these tests in a coordinated framework in the light of the lessons learned from the accident in Japan and with the full involvement of Member States, making full use of available expertise (notably from the Western European Nuclear Regulators Association)"*.

On 13 May 2011, ENSREG and the European Commission, with the help of WENRA, agreed upon *"an initial independent regulatory technical definition of a "stress test" and how it should be applied to nuclear facilities across Europe"*.

The "stress tests" is defined *"as a targeted reassessment of the safety margins of nuclear power plants in the light of the events which occurred at Fukushima: extreme natural events challenging the plant safety functions and leading to a severe accident."*

The reassessment consists:

*"In an evaluation of the response of a nuclear power plant when facing a set of extreme situations envisaged under the following section "technical scope" and in a verification of the preventive and mitigative measures chosen following a defence-in-depth logic: initiating events, consequential loss of safety functions, severe accident management.*

*In these extreme situations, sequential loss of the lines of defence is assumed, in a deterministic approach, irrespective of the probability of this loss. In particular, it has to be kept in mind that loss of safety functions and severe accident situations can occur only when several design provisions have failed. In addition, measures to manage these situations will be supposed to be progressively defeated"*.

For a given plant, the reassessment will report on the response of the plant and on the effectiveness of the preventive measures, noting any potential weak point and cliff-edge effect, for each of the considered extreme situations. A cliff-edge effect could be, for instance, exceeding a point where significant flooding of plant area starts after water overtopping a protection dike or exhaustion of the capacity of the batteries in the event of a



station blackout. This is to evaluate the robustness of the DID approach, the adequacy of current accident management measures and to identify the potential for safety improvements, both technical and organisational (such as procedures, human resources, emergency response organisation or use of external resources).

By their nature, the stress tests will tend to focus on measures that could be taken after a postulated loss of the safety systems that are installed to provide protection against accidents considered in the design. Adequate performance of those systems has been assessed in connection with plant licensing. Assumptions concerning their performance are reassessed in the stress tests and they should be shown as provisions in place. It is recognised that all measures taken to protect reactor core or spent fuel integrity or to protect the reactor containment integrity constitute an essential part of the DID, as it is always better to prevent accidents from happening than to deal with the consequences of an occurred accident.

The stress test analysis will be organized into Three Topical Reviews, performed by ad-hoc teams working in parallel, each on one of the following topics:

1. earthquake, flooding and other external events;
2. loss of power, loss of UHS and combination of loss of power + loss of UHS;
3. severe accident management issues.

The present work will be devoted specifically on the preliminary analysis of a Station Blackout scenario for a GenIII+ reactor.

In particular, two situations have to be considered:

- **SBO:** LOOP + Loss of the AC back-up electrical power sources (loss or all emergency Diesel Generators)
- **Total SBO:** LOOP + Loss of the AC back-up sources + loss of any other diverse back-up electrical sources (DC batteries)

All offsite electric power supplies are assumed to be lost for several days. The site is isolated from delivery of heavy material for 72 hours by road, rail, and waterways. Portable light equipment can arrive to the site from other locations after the first 24 hours.



## 4 A GenIII+ reactor: AP1000 with passive safety systems

The AP1000 is an 1100MWe pressurized water reactor (PWR) designed by Westinghouse. The plant is based on the AP600 designed by the same company and "It's the only Generation III+ reactor to receive Design Certification from the U.S Nuclear Regulatory Commission (NRC)\*\*".

The Major innovation of AP1000 is the use of passive safety features; they reduce significantly the probability of core damage frequency (CDF) and meet the NRC probabilistic risk criteria with large margins.

	NRC Req	Current Plants	URD Req	AP1000
CDF	$1 \times 10^{-4}$	$5 \times 10^{-5}$	$1 \times 10^{-5}$	$5 \times 10^{-7}$

When the first line of defence-in-depth (DID), represented by highly reliable non-safety systems, fails, the passive safety-related systems actuate automatically to maintain core cooling and containment integrity with no operator action and no on-site or off-site ac power sources.

### 4.1 Passive Core Cooling System

The Passive Core Cooling System (PXS) has two main functions:

- A) Passive decay heat removal
- B) Passive safety injection

A) Passive decay heat removal is implemented by the Passive Residual Heat Removal (PRHR) system

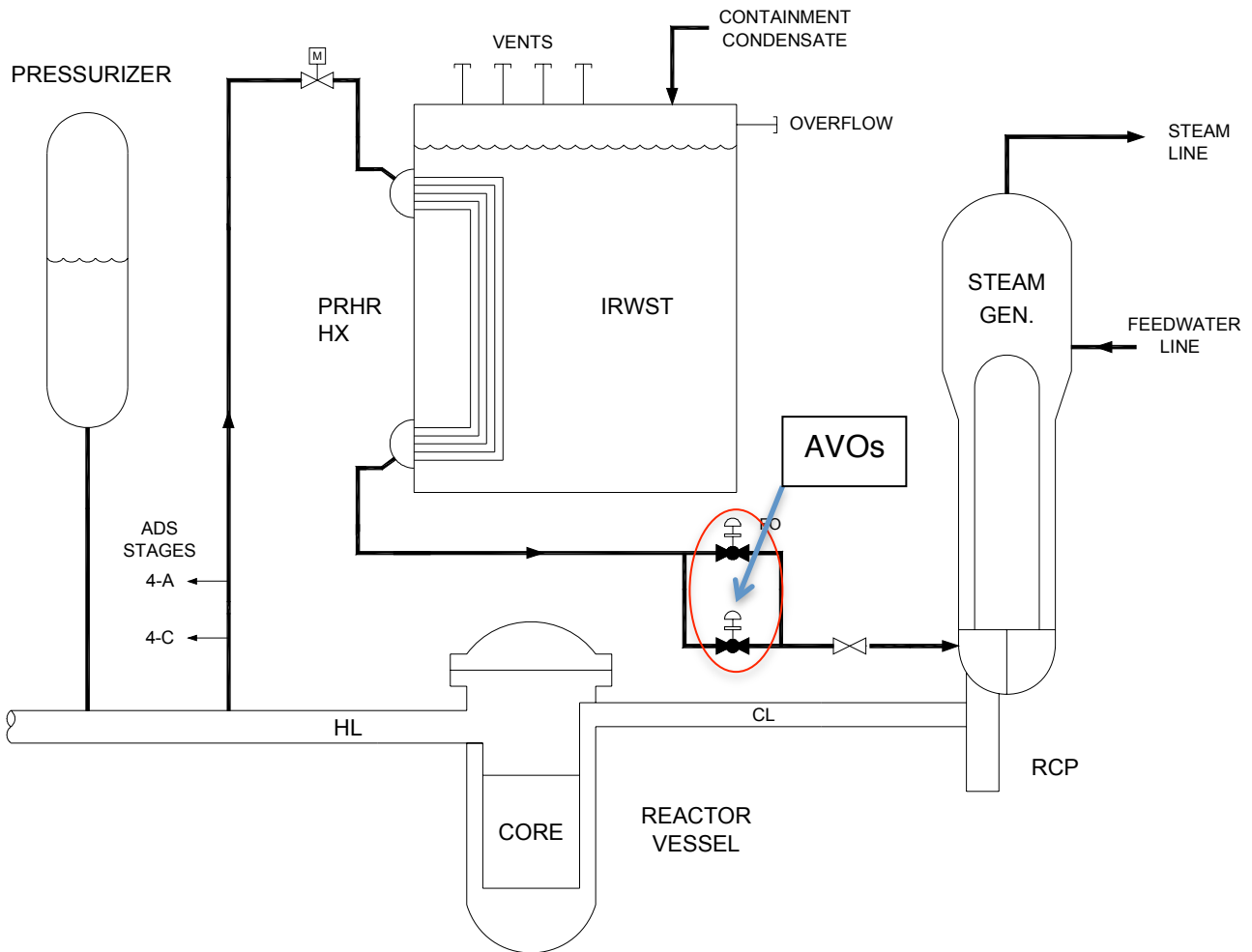

Fig 3: PRHR system

The PRHR system is a subsystem of the passive core cooling system (PXS) and is a Seismic Category I, safety-related system. It consists of one PRHR heat exchanger and associated valves, piping and instrumentation. The heat exchanger is located in the in-containment refueling water storage tank (IRWST), which provides the heat sink. The heat exchanger is maintained full of cold reactor coolant system (RCS) coolant at full RCS pressure. The heat exchanger connects to the RCS by an inlet line from one RCS hot leg through a tee from one of the fourth stage automatic depressurization lines. The outlet line from the PRHR heat exchanger to the RCS cold leg has two parallel, normally closed, air-operated flow control valves that fail open upon loss of air pressure or on control actuation signal. The heat exchanger inlet line contains a normally open motor-operated isolation valve that connects to the upper PRHR heat exchanger channel head. The heat exchanger



is elevated above the RCS loops to induce natural circulation flow when the RCS pumps are not available. The IRWST gutter circumnavigates the containment shell. The purpose of the gutter is to collect condensed water on the containment shell and, in the event of PRHR actuation, return the water to the IRWST, allowing the PRHR heat exchanger to remain submerged in water.

B) Passive safety injection is implemented by CMTs, accumulators, IRWST

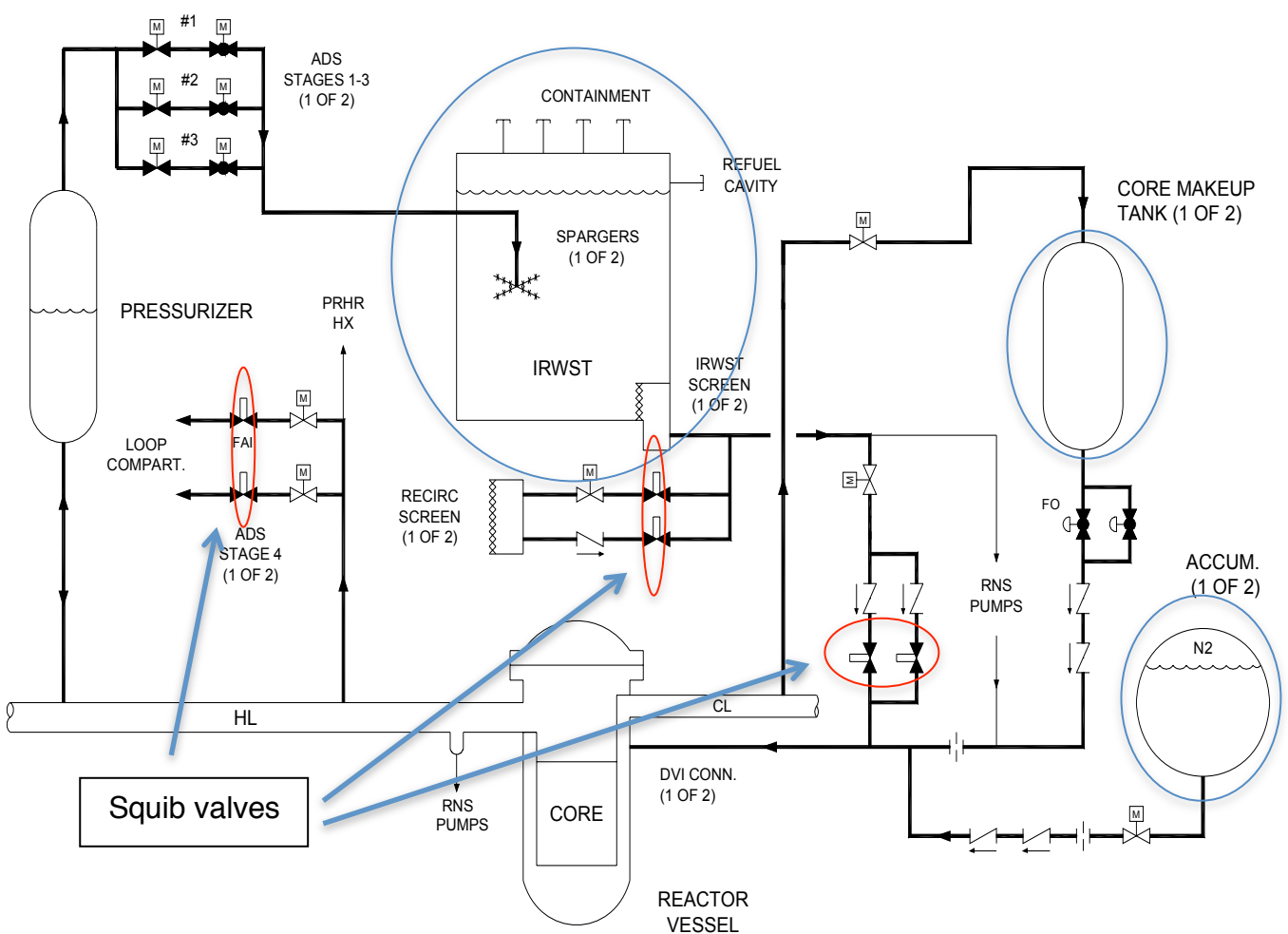

Fig 4: Safety Injection systems

The core makeup tank subsystem is a passive, safety-related subsystem that injects water into the reactor coolant system (RCS) if inventory is being lost. Steam (if the cold leg is



voided) or water (if the cold leg is solid) is supplied to the core makeup tank to displace the cold injection water.

The accumulator's function is to provide water into the reactor coolant system (RCS) if the reactor coolant system pressure falls below the accumulator pressure.

The automatic depressurization system (ADS) valves act in conjunction with the passive core cooling system (PXS) to mitigate accidents. Their function is to reduce the reactor coolant system (RCS) pressure in a controlled fashion to allow the required safety injection flow rates from the accumulators, and in-containment refueling water storage tank (IRWST). It is required primarily to mitigate loss of coolant accidents.

The function of the IRWST/gravity injection is to provide flooding of the refueling cavity for normal refueling, post-loss-of-coolant-accident (LOCA) flooding of the containment to establish long-term reactor coolant system (RCS) cooling, and to support the passive residual heat removal (PRHR) heat exchangers (HXs) operation.

## 4.2 Passive Containment Cooling System

The PCS is a safety-related system that functions to reduce containment temperature and pressure following a loss-of-coolant accident (LOCA), a main steam line break (MSLB) accident inside containment, or other events that cause a significant increase in containment pressure and temperature. The PCS achieves this by removing thermal energy from the containment atmosphere to the environment via the steel containment vessel. Heat is removed from containment by a continuous natural circulation flow of air, during an accident the air cooling is supplemented by evaporation of water. The water drains by gravity from a tank located on the top of the containment shield building (PCCWST)

There are three redundant drain lines from PCCWST: in two lines there are a normally opened motor operated valve (MOV) in series with a normally closed Air operated valve



(AOV) and in the third there are a normally opened MOV in series with a normally MOV. For the success of PCS it sufficient that one of three lines is operating.

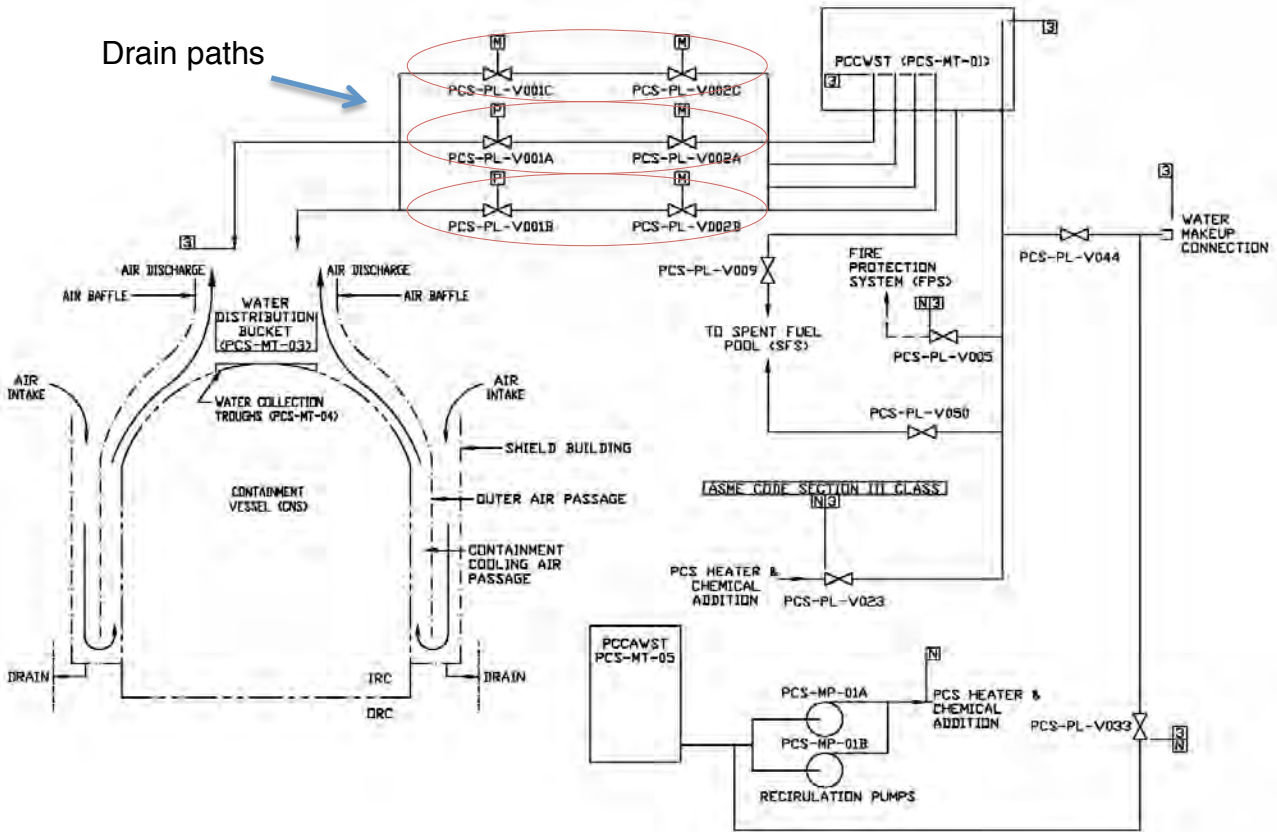

Fig 5: PCS



## 5 AP1000 response to Total Station Blackout

In order to evaluate AP1000 response to total station blackout, only data from AP1000 design control document (DCD) is used, site-specific upgrades that could be adopted by plant owner are not taken in consideration in this report.

The goal of this study is focused on response of reference AP1000 reactor to a Fukushima-like flooding event regardless the probability of occurrence of the event.

### ➤ AP1000 Layout

The AP1000 has five principal structures. Each of these buildings is constructed on an individual basement:

- Nuclear island (Containment building, shield building, Auxiliary building)
- Turbine building
- Annex building
- Diesel generator building
- Radwaste building

The AP1000's systems, structures and components (SSCs) are subdivided and designed as Seismic Category I, II and no-seismic. Seismic Category I SSCs are designed to withstand the Safe Shutdown Earthquake (SSE) and continue to perform their safety-related function. Seismic Category II SSCs are designed to withstand the SSE without damaging a safety-related SSC. Seismic Category II SSCs are not required to remain functional after the earthquake. Non-Seismic SSCs are designed to the Industry Building Codes. Safety related systems are located inside nuclear island.

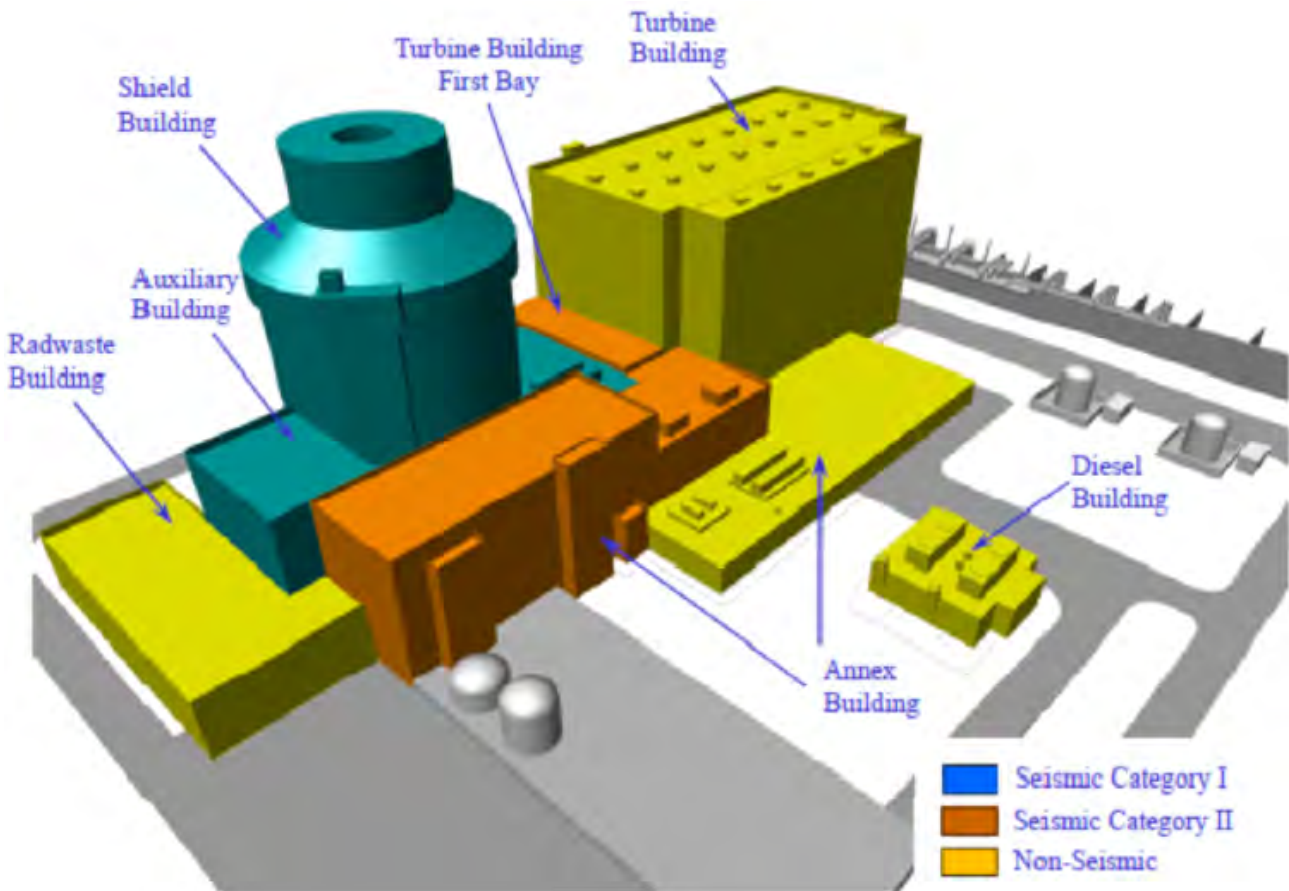

Fig 6: AP1000 Layout with seismic classification

All passive safety systems are located inside the steel containment vessel (44.5 mm thick) surrounded by the shield building.

The maximum flood level assumed for AP1000 is the plant design grade elevation. Actual grade will be a few inches lower to prevent surface water from entering doorways

The Class 1E battery banks are located under ground level in the Non-Radiologically-Controlled Auxiliary (Non-RCA) Building.

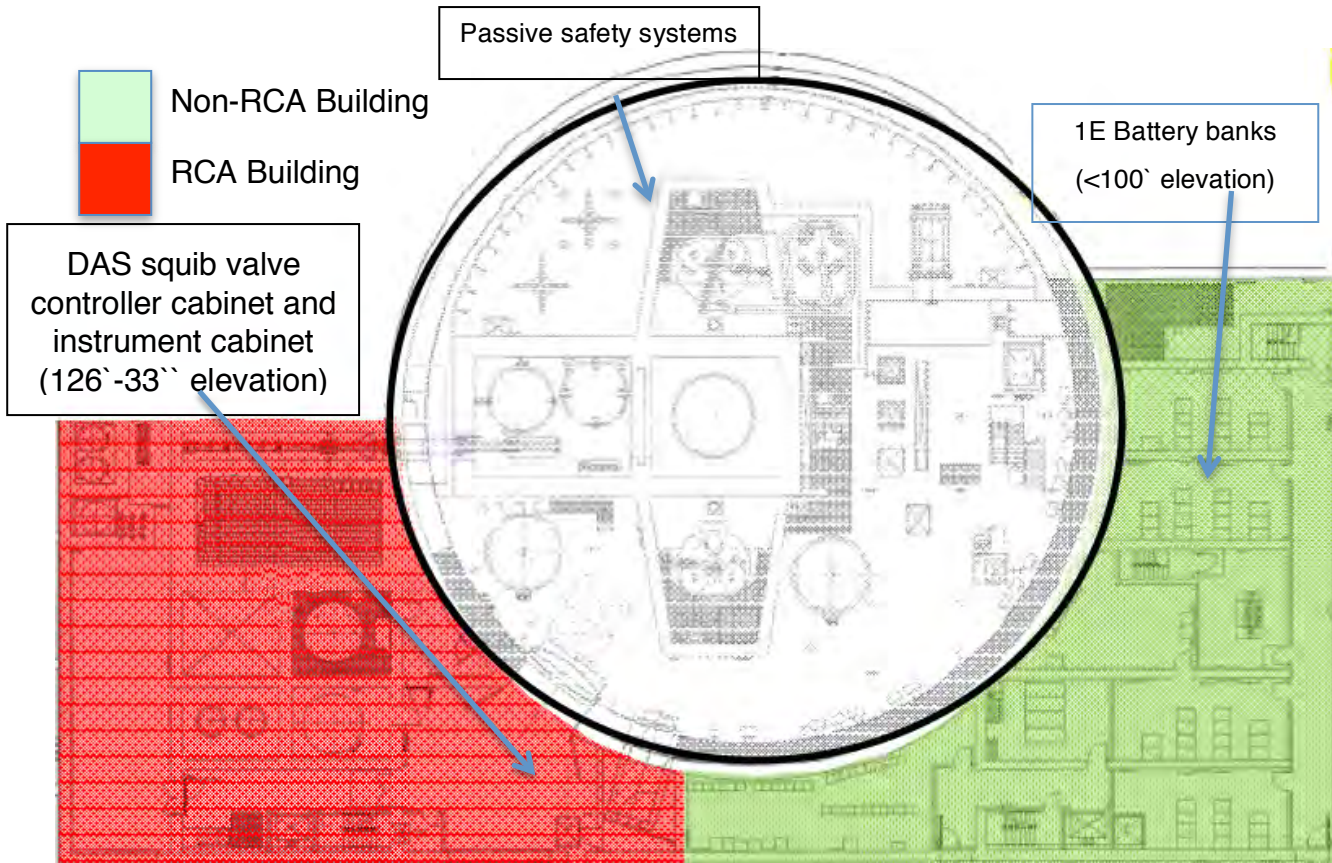

Fig 7: Generic Nuclear Island level (the grade elevation=100`)

➤ Fukushima-like event

At Fukushima the tsunami had hit the Dai-ichi about 50 minutes later after earthquake, In this report it's supposed a worse situation that could happen to a reactor, that the earthquake and flooding are occurred in the same time. It's also assumed that the reactor is at power.

As result of the earthquake and flooding, the most conservative situation is assumed in which all active non-safety related systems and those outside the nuclear island are lost, including:

- The loss of off-site power
- The loss of standby and ancillary diesel generators
- The loss of non-safety related battery banks
- The loss of main and startup feedwater systems
- The loss of normal residual heat removal systems

And the following safety related systems unavailable due to flooding:



- The loss of Class 1E battery banks
- The loss of Protection and Monitoring System (PMS)

It's also assumed that the Main Control Room (MCR) is inoperative, and the DAS squib valve controller cabinet and instrument cabinet, which is located inside RCA auxiliary building at 126` elevation with its independent battery supply is supposed to operate after earthquake and flood.

➤ Accident's evolution

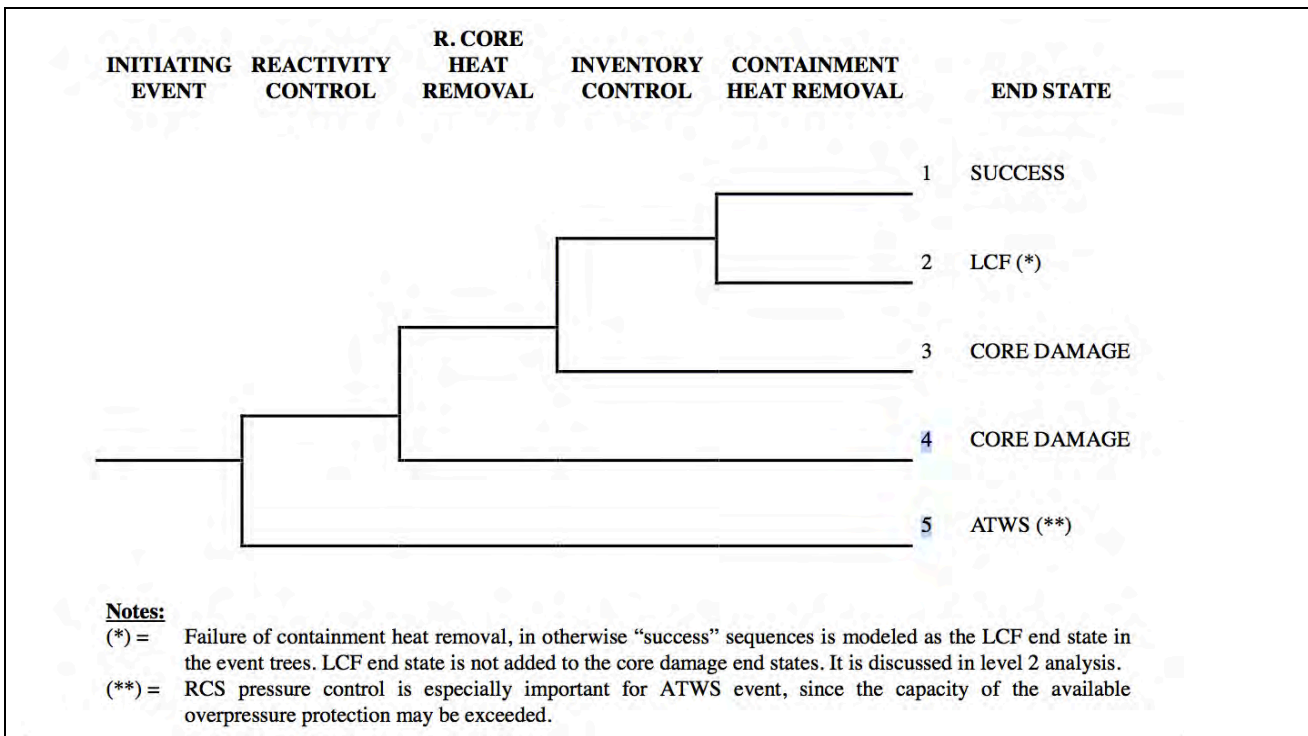

Fig 8: Event tree model

The reactor is automatically tripped after earthquake, the loss of AC power would de-energize the brakes that hold the control rods, and so the shutdown of the reactor is achieved successfully.



The seismic category I SSCs of AP1000 are supposed to resist the earthquake and the passive safety systems inside the steel containment vessel are not affected by the flooding event. Also the RCS, which is inside the steel containment vessel, is supposed to withstand following the accident, i.e. no loss of coolant.

Since the reactivity control is supposed to have success and RCS boundary is assumed to be intact; the reactor residual heat removal function is needed to prevent core damage. In a postulated SBO accident, the non safety-related DID active system (RNS, MFWS and SFWS) are assumed to fail or not properly operating, whatever lost due to initial external hazards or to loss of AC power. The only mean available in first stage of accident is the PRHR HX, as noted below its correct actuation is fundamental to the safety recovery of reactor.

The PRHR HX described in chapter 4, is a completely passive system, i.e. no need of either AC or DC power for this actuation. The AOVs at outlet line of PRHR HX (Fig 3) would be opened by loss of control power or compressed air, i.e. in its safe fail-open position, while the MOV of inlet line is already open. The residual heat removal is performed by water's natural circulation. The heat is transferred to IRWST's water by heat exchanger.

The IRWST's water will reach the saturated temperature in few hours and the steam generated is released to containment vessel and is cooled by PCCWST's water, the condensed water is collected and returned to IRWST.

With the plant in normal operation, the water dropped in containment vessel is collected to sump. The use of AOVs in the collect paths to IRWST and to sump, permit that in case of accident they will in their fail-safe position, i.e. the paths to IRWST will be opened and the ones to sump closed in a postured SBO.

To prevent the over-pressurization of the containment, i.e. the containment vessel heat removal, the PCS should be actuated and the amount of PCCWST's water ensures that the pressure of containment will be under the design pressure in the first three days (at least) after the accident occurrence.

In case of **SBO** the drain paths of PCS are three, while in case of **total SBO** the drain paths of PCS (Fig 5) are supposed to reduce to two instead of three. It's assumed that at loss of power or loss of compressed air, the paths with AOV are actuated since the AOVs



are in their safe fail-open position, while the MOV path one is assumed to fail since the MOV fails "as is". The PCS's success criterion is one drain path actuated.

To avoid core damage is necessary the successful actuation of PRHR HX, the availability of return paths of containment water to IRWST and one out of three drain paths of PCS. As reported the PCS have at least three days range of water supply. All this is done without operator actions by virtue of passive safety systems design of AP1000.

In an unlikely event sequence that the PRHR HX fails, the missed residual heat removal would over-pressurize the reactor and turn in to a potential high-pressure core damage state (see SBO event trees). Full depressurization of RCS should be actuated to prevent the core damage.

➤ Depressurization of RCS

In case of SBO, the battery banks are still available, the success criteria of full depressurization of RCS is

- Automatic actuation of 2 out of 4 of ADS 4<sup>th</sup> stage lines
- Automatic actuation of 3 out of 4 of ADS 2<sup>nd</sup> and 3<sup>rd</sup> stage lines.
- Manual actuation of 2 out of 4 ADS 4<sup>th</sup> stage lines

The depressurization of RCS allows the safety injection of borated cool water from ACCs and IRWST to the reactor. When the level of water in reactor cavity reach a designed level, the recirculation path is actuated for long term cooling. As for the PRHR HX success case, the reactor will be in a safety state for at least three days, assumed that the PCS is actuated.

In case of a Total SBO, the full depressurization of RCS is manual actuated from DAS instrument cabinet by opening of squib valves of ADS 4<sup>th</sup> stage lines, same for the squib valves of safety injection lines and of recirculation lines.

The adoption of the squib valves in ADS's 4<sup>th</sup> stage, IRWST's gravity injection lines and recirculation lines is justifies by the need to prevent spurious actuation that can result in adverse effects on the overall plant safety. The squib valves fail at their normal position



(closed) and this inhibit the accomplishment of their safety function in case of a complete loss of power.

## 5.1 Total Station Blackout PRA

Two event trees are proposed for **SBO** following the indication of ENSREG's "stress tests"

- SBO
- Total SBO: SBO + loss of batteries (except batteries of DAS at 126`-33`` elevation)

In case of SBO event (page 32), the total conditional probabilities for unsafe states are estimated as follows:

- **Core Damage with Reactor at High Pressure (HCD):** 1.05E-07 due to the PRHR's and ADS's failure.
- **Core Damage with Reactor Depressurized (LCD):** 2.33E-07 due to the failure of PRHR, success of ADS and failure of either IRWST's injection or reactor recirculation.
- **Late Containment Failure (LCF):** 9.86E-05 due to the failure of PCS after the success actuation of PRHR

In case of **total SBO** event (page 33), the total conditional probability for unsafe states are estimated as follows:

- **Core Damage with Reactor at High Pressure (HCD):** 2.36E-06 due to the PRHR's and ADS's failure.
- **Core Damage with Reactor Depressurized (LCD):** 3.01E-08 due to the failure of PRHR, success of ADS and failure of either IRWST's injection or reactor recirculation.
- **Late Containment Failure (LCF):** 9.86E-05 due to failure of PCS after the success actuation of PRHR.

For total SBO case it's assumed a conservative operator error, 1.16E-02, for manual actuation of squib from DAS squib valve controller cabinet

The conditional probability for HCD in case of SBO and Total SBO are illustrated in the following figure:

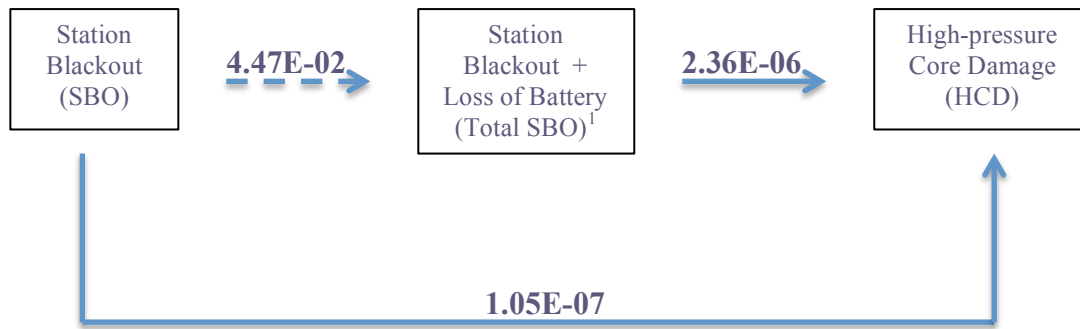

Late containment failure is a not immediate core damage state. The containment vessel would not fail if the containment cooling system were re-established within 24 hours.

## 5.2 Systems, Structures and Components important for safety of reactor

The PRA study has point out the SSCs that are fundament for the safety of reactor.

- The PRHR HX

In both SBO event tree, normal or total, the success actuation of PRHR system will bring the reactor to a safe state or to LCF, dependent on whether the PCS actuation is successful or not, i.e. the states correspond to its actuation are not an immediate core damage state like HCD or LCD and also means that the operators have at least three days in case of reactor in safe state and one day in case of LCF, to find alternative off-site options for plant recovery.

- DAS squib valve controller cabinet and instrument cabinet

The availability of these cabinets reduces the HCD conditional probability of a factor of 85 of conditioned probability of HCD in the worst situation of Total SBO.

These cabinet are located in the security station of the auxiliary building on the 126'-3" elevation. Protected from earthquake and flood. They provided an alternative redundant method for actuation of

ADS 4<sup>th</sup> stage squib valves

IRWST's safety injection line squib valves

Recirculation lines squib valves



And they have their own battery supplies.

- The 24h and 72h Class 1E batteries

The Class 1E batteries availability reduces the HCD conditional probability of a factor of 20, from 2.36E-06 (total SBO-no batteries) to 1.05E-07 (SBO-batteries available).

In AP1000 there are six banks of safety related Class 1E batteries, which power vital DC and AC loads; AC loads are powered through an Uninterruptible Power Supply (UPS) system. In particular the four banks of 24h batteries provide the alignment of valves (Air-operated, Motor-operated, squib) to guarantee the operability of PXS, PCS and CNS while the two banks of 72h batteries provide lighting for the Main Control Room and monitoring critical instrumentation.



## 6 Conclusion and considerations

In a severe accident situation, all auxiliary systems on-site could be destroyed and damaged by earthquake and flood. AP1000 will resist for at least 3 days, since it relies on passive systems.

The use of passive safety systems, which no dependent on active feature as pumps or diesel neither on AC power, reduce significantly the probability of core damage even in a Fukushima-like event. The conditional probability of a core damage starting from the worst case of a total station blackout is still very low: estimated  $2.38E-6^1$ . This means that the plant maintains, in this severe condition, a robust set of mitigating safety features to prevent core damage.

To gather the safety-related systems in a same basement of seismic category I and to put the passive safety systems inside the steel containment vessel reduced significantly the challenge from external hazards like flood and earthquake.

In addition the AP1000 has pre-built safety-related connections for off-site equipment adopted for emergency procedures aimed to recover the reactor after 3 days. These features have not been considered in the analysis but they can be used also to cope with a Fukushima like accident.

The batteries and all equipment rooms necessary for activation of squib valves could be more protected in event of flood by watertight doors.



Event trees

Normal SBO event tree

SBO	PRHR	CMT	ADS-F	ACC	IRWST	CIS	RECIRC	PCS	No.	Freq.	Conseq.	Code
									1		OK	
									2	9.86E-05	LCF	PCS
									3		OK	PRHR
									4	1.99E-08	LCF	PRHR-PCS
							1		5	1.93E-07	LCD	PRHR-RECIRC
									6	3.47E-07	OK	PRHR-CIS
									7	3.42E-11	LCF	PRHR-CIS-PCS
							2		8	1.57E-09	LCD	PRHR-CIS-RECIRC
					1				9	3.82E-08	LCD	PRHR-IRWST
			1						10	9.87E-08	HCD	PRHR-ADS-F
									11		OK	PRHR-CMT
									12	4.02E-12	LCF	PRHR-CMT-PCS
							1		13	3.89E-11	LCD	PRHR-CMT-RECIRC
									14		OK	PRHR-CMT-CIS
									15	6.91E-15	LCF	PRHR-CMT-CIS-PCS
							2		16	3.17E-13	LCD	PRHR-CMT-CIS-RECIRC
					2				17	1.08E-11	LCD	PRHR-CMT-IRWST
									18	2.82E-12	LCD	PRHR-CMT-ACC
			2						19	6.73E-09	HCD	PRHR-CMT-ADS-F



**TOTAL SBO EVENT TREE**

SBOBAT	PRHR	CMT	ADS-F	ACC	IRWST	CIS	RECIRC	PCS	No.	Freq.	Conseq.	Code
									1		OK	
									2	9.86E-05	LCF	PCS
									3		OK	PRHR
									4	1.99E-08	LCF	PRHR-PCS
							3		5	2.43E-09	LCD	PRHR-RECIRC
									6		OK	PRHR-CIS
									7	3.42E-11	LCF	PRHR-CIS-PCS
							4		8	5.06E-12	LCD	PRHR-CIS-RECIRC
						3			9	1.37E-08	LCD	PRHR-IRWST
									10	1.40E-08	LCD	PRHR-ACC
			3						11	2.36E-06	HCD	PRHR-ADS-F

**Titolo**
**Analisi di affidabilità dei misuratori di flusso neutronico in-core**
**Ente emittente** CIRTEN UNI PI

# PAGINA DI GUARDIA

**Descrittori**
**Tipologia del documento:** Rapporto tecnico

**Collocazione contrattuale:** ACCORDO DI PROGRAMMA Ministero dello Sviluppo Economico – ENEA sulla Ricerca di Sistema Elettrico PIANO ANNUALE DI REALIZZAZIONE 2010 Progetto 1.3.2.a: Fissione nucleare: Metodi di analisi e verifica di progetti nucleari di generazione evolutiva ad acqua pressurizzata.

**Argomenti trattati:** Fisica dei reattori nucleari, Metodi Montecarlo

**Sommario**

A reliability analysis of Self-Powered Neutron Detectors (SPNDs), used to measure the neutron flux distribution inside the reactor core, is performed with a Monte Carlo technique, based on the following hypotheses:

- 1) The detectors under consideration are electronic devices with a corresponding failure rate, which can be different from detector to detector (in particular, a Gaussian probability distribution function of the results of each measurements obtained with each detector can be simulated);
- 2) Based on the increment of the instrument error reading after a device failure, the evaluation of the measurement error can be performed as a consequence of localized neutron flux variation.

**Note**

Copia n.

In carico a:

2			NOME			
			FIRMA			
1			NOME			
			FIRMA			
0	EMISSIONE	30/11/2011	NOME	O. Aronica	P.C. Incalcaterra	M. Sepielli
			FIRMA			
REV.	DESCRIZIONE	DATA	CONVALIDA	VISTO	APPROVAZIONE	



**CIRTEN**

**Consorzio Interuniversitario per la Ricerca TEcnologica Nucleare**

**UNIVERSITY OF PISA**

## **Analisi di affidabilità dei misuratori di flusso neutronico in-core**

**Autori**

**Francesco d'Errico**

**Riccardo Ciolini**

**CERSE-UNUPI RL 1513/2011**

**Pisa, Novembre 2011**

Lavoro svolto in esecuzione dell'Obiettivo 4.2 Attività A2

AdP MSE-ENEA sulla Ricerca di Sistema Elettrico- Piano Annuale di Realizzazione 2010

Progetto 1.3.2.a "Fissione nucleare: Metodi di analisi e verifica di progetti nucleari di generazione evolutiva alimentati ad acqua pressurizzata"

## **Obiettivo 4.2 - Attività A.2 - Analisi di affidabilità dei misuratori di flusso neutronico in-core**

Si dovrà condurre un'analisi di affidabilità su un insieme di misuratori neutronici preposti alla ricostruzione della distribuzione del flusso all'interno del nocciolo. L'analisi si baserà sulle seguenti ipotesi:

- 1) trattasi di un dispositivo elettronico con associato un suo tasso di guasto;
- 2) il dispositivo elettronico fornirà una misura distribuita secondo una distribuzione di probabilità di tipo gaussiano;
- 3) a fronte di un guasto del dispositivo si suppone che sia noto di quanto il guasto del dispositivo stesso aumenti l'errore da esso commesso. Verrà esaminato anche il caso in cui il flusso neutronico ( $F$ ) della zona considerata non sia una variabile aleatoria  $F$ , bensì un processo aleatorio  $F(t)$ , come nel caso in cui nel modello venga considerata la fisica del reattore.

## **Introduction**

In the present work, a reliability analysis of Self-Powered Neutron Detectors (SPNDs), used to measure the neutron flux distribution inside the reactor core, is performed with a Monte Carlo technique. A brief overview is first given of the different types of nuclear reactor core instrumentation, with particular reference to the SPND instrumentation used in the European Pressurized Reactor (EPR).

The reliability analysis is based on the following hypothesis:

- 1) The detectors under consideration are electronic devices with a corresponding failure rate, which can be different from detector to detector (in particular, a Gaussian probability distribution function of the results of each measurements obtained with each detector can be simulated);
- 3) Based on the increment of the instrument error reading after a device failure, the evaluation of the measurement error can be performed as a consequence of localized neutron flux variation, whose time distribution can be obtained as a stochastic process or output of reactor physics calculations.

## **1. Description of the of SPNDs**

### *1.1 In-core and ex-core detectors*

For nuclear reactors, a major component of reactor operation and safety is the ability to predict and measure the nuclear power (or neutron flux) level and the three-dimensional distribution of power in the core. The measurement of the power level is normally performed using ex-core instrumentation, which give information only about the core integrated flux and provides signals to monitor core criticality, while the determination of the spatial variation of the neutron flux, required to control the axial power distribution, for core surveillance and protection and for fuel management, is obtained with in-core instrumentation.

The Self-Powered Neutron Detectors (SPND) belong to the category of in-core nuclear reactor instrumentation and they are part of the power reactor control system and the reactor safety system. This type of detectors are generally sensitive to thermal neutrons and their fundamental properties is their resistance to the extreme conditions inside the reactor core, which are normally not found in all the other fields of nuclear measurements.

The reactor instrumentation is subdivided in two broad categories:

- in-core detectors;
- ex-core detectors.

The in-core detectors are located inside the coolant channels of the reactor core to measure the point neutron flux level inside the core itself. They operate at very extreme conditions:

- neutron flux of  $5 \cdot 10^{13}$  n/(cm<sup>2</sup>s);
- gamma flux up to  $10^8$  R/h;
- operating temperature up to 300 °C;
- external operating pressure up to 170 bar.

Moreover, these detectors have to be very compact and miniaturized: for geometrical reasons, their external dimensions are normally less than 10 mm.

The only type of detectors that can satisfy all the previous requirements are fission chambers or self-powered neutron detectors (SPNDs), the latter are the subject of the present work.

This type of detectors can be repaired or replaced only during refuelling outages: this fact is considered as a limiting factor in the detector reliability, compared to the ex-core instrumentation.

Ex-core detectors are positioned outside the core to measure quantities related to the integrated neutron flux. These detectors can be inside or outside the vessel; in all cases their working conditions are less severe than for in-core detectors and their dimensions are not strictly determined by geometrical constraints.

The reactor instrumentation varies with the type of reactor, but there are some common aspects for all types of plants. In particular three power levels can be identified:

- 1) initial startup range;
- 2) low power range;
- 3) power range.

Each level corresponds to different types of detectors and/or different modes of operation of the same type of detector (Fig. 1). A minimum overlap of one decade of thermal neutron flux is recommended between successive ranges of instrumentation. This overlap permits to maintain a continuity of measurement between the ranges of sensitivity. The limit of each region can vary from plant to plant, but the logic is the same.

The initial startup range is characterized by a high gamma flux level with respect to the thermal neutron flux. This requires good gamma discrimination properties of the neutron detectors, normally obtained with fission chambers or BF<sub>3</sub> proportional counters in pulse mode operation. A typical solution is the use of two detectors placed on opposite sides of the core (Fig. 2).

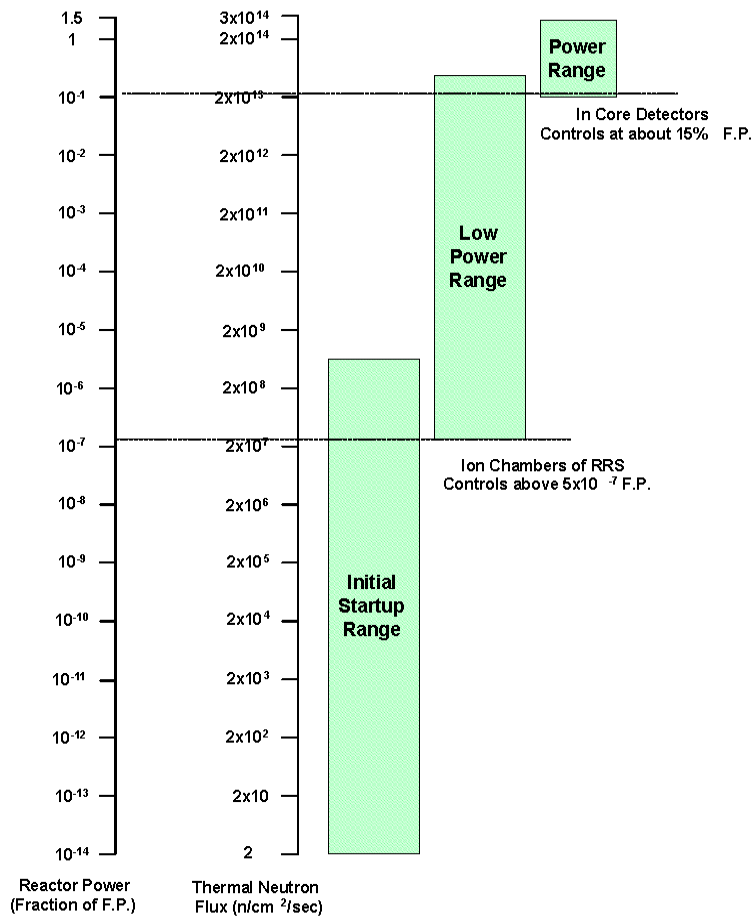

Figure 1: Working ranges of reactor core instrumentations [1].

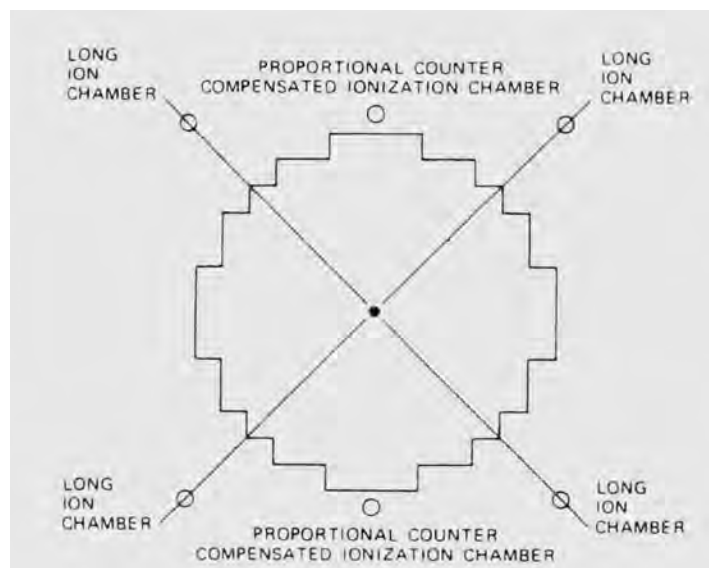

Figure 2: Schematic arrangement of ex-core detectors in the PWR core [1].

In the low power range (known also as intermediate range), the pulse mode operation is no longer possible because the neutron interaction rate is too high. However, the current operation mode is not yet applicable because the gamma flux level is not negligible with respect to the thermal neutron flux. As a consequence, in this range it is necessary to use the “Campbell method” with fission chambers or  $\text{BF}_3$  proportional counters, or a direct gamma ray compensation using a compensated ion chamber to discriminate the neutron signal from the gamma background. Normally, two detectors placed on opposite sides of the core are employed: they are located in the same position of the startup range detectors or on the two opposing sides (Fig. 2).

In the power range, the gamma contribution is negligible and thus simple ion chambers in current mode can be used. In most applications, four long ion chamber are used, located at  $90^\circ$  interval positions around the vessel so to have a radial control of the reactor flux. Each long ion chamber is formed by two uncompensated ion chambers arranged end-to-end, resulting in a total detector length of 3-4 m to provide also an axial monitoring of the power reactor flux. The SPNDs are used in the power range to give a measurement of reactor power from source level up to 150% of full power. The SPNDs are always operated in current mode, because pulse mode operation is impractical (the signal from a single neutron interaction is at best a single electron).

### *1.2 Operating principles of SPNDs*

This type of detectors does not require external bias voltage: they contain a material with high thermal neutron capture cross section, leading to subsequent beta or gamma decay to form the current signal detector.

Two possibilities can be exploited for SPNDs:

- 1) detectors based on beta decay: a direct measurement of the saturation beta decay current following capture of neutrons is the detector signal. This current is proportional to the rate of neutron captures in the detector;
- 2) detectors based on secondary electrons from gamma decay: the secondary electrons produced by the interaction of gamma rays following neutron captures determines the electric signal of the detector.

Some advantages of both type of detectors are small size, low cost and simple electronics. Some disadvantages relate to the low level of the output current and to the high sensitivity of the output current to variations in the neutron energy spectrum. The SPNDs based on beta decay are more sensitive than the others, but they have a slower response time.

In self-powered detectors, the effects of neutron and gamma-ray interactions occurring in the connection cable can be quite significant. Normally, the SPND is connected to an amplifier by a twin lead coaxial cable (compensation wire) for the elimination of the gamma background (a current produced as a result of the cable irradiation): one lead is connected through the cable to the emitter, whereas the other is included within the same cable but it terminates without electrical contact physically near the emitter. The signal is obtained by electronic subtraction of the unconnected lead signal from the current detected from the lead connected to the emitter. The use of a single cable is also possible.

### 1.3 SPNDs based on beta decay

The detectors comprises an emitter, which presents a high cross section for neutron capture leading to a beta-active radioisotopes, and a collector, which collect the beta electrons from the emitter (Fig. 3). Both the collector and the insulator are made with materials with low neutron cross sections. Between the emitter and the collector there is an insulator of magnesium or aluminium oxide: this has to withstand the high temperature and intense radiation environment inside the reactor core.

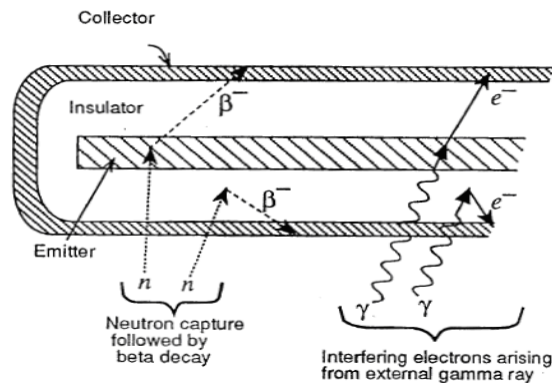

Figure 3: Events that take place in a SPND based on beta decay (the external diameter of the device is normally less than 2 mm) [1].

Examples of material for the emitter are vanadium or rhodium. Vanadium produces a beta decay with a half-life of 225 s, whereas rhodium produces two beta decays, one with 44 s half-life and the other with 265 s. Vanadium has a lower sensitivity and response than rhodium, but its rate of burn-up is less than rhodium. The collectors are made of high-purity stainless steel or Inconel.

At saturation, when the detector has been exposed to the neutron flux for a period of time that is long compared with the half-life of the induced activity, the steady-state current is given by:

$$I_{sat} = C\sigma N\varphi q \quad (1)$$

where  $C$  is a dimensionless constant reflecting the specific geometry and the collection efficiency of the detector,  $\sigma$  is the activation cross section of the emitter material (Table 1),  $N$  is the number of emitting atoms,  $\varphi$  is the neutron flux and  $q$  is the charge liberated per neutron absorbed. The saturation current is proportional to the neutron flux and consequently can be used as a monitor of the neutron flux level.

Table 1: Properties of emitter materials for SPND based on beta decays [1]

Emitter material	Nuclide of interest	Percent abundance (%)	Activation cross section at thermal energy (barn)	Half-life of induced beta activity (s)	Beta endpoint energy (MeV)	Typical neutron sensitivity ( $A \cdot cm^2 \cdot s$ )
Vanadium	$^{51}\text{V}$	99.750	4.9	225	2.47	$5 \cdot 10^{-23}$
Rhodium	$^{103}\text{Rh}$	100	139 ( $^{104}\text{Rh}$ )	44	2.44	$1 \cdot 10^{-21}$
			11 ( $^{104m}\text{Rh}$ )	265		

This is the ideal case, but in reality other phenomena are involved:

- neutron flux depression caused by the emitter self-shielding;
- Compton and photoelectrons produced from gamma rays;
- self-absorption of beta particles within the emitter;
- absorption of beta particles in the insulator before reaching the collector;
- production of electrons within the insulator, which can then move towards the emitter or the collector.

In every case, after some period of operation an equilibrium current is established inside the detector. All the previous “not ideal” processes contribute to less than 15% of the primary current.

#### 1.4 SPNDs based on secondary electrons from gamma decay

These detectors rely on the secondary electrons produced by prompt capture gamma rays that follow the neutron capture events in the emitter (Fig. 4). Capture gamma rays are typically emitted

within a very small fraction of a second, as opposed to the much slower decay of the SPNDs based on beta decay. For this reason the response time is faster than in the previous types of SPNDs, but the sensitivity is significantly lower.

Also in this case, gamma rays directly incident on the detector can give rise to secondary electrons which can contribute to the signal in a non-negligible way. This contribution can be positive or negative, because the net flow of current may be either in the same or opposite direction to the neutron-induced current, depending on the specific construction of the detector.

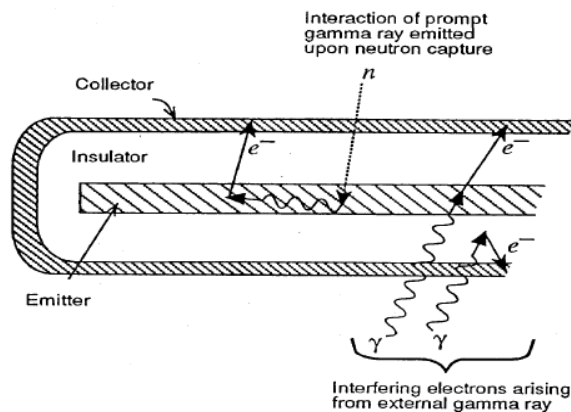

Figure 4: Events that take place in a SPND based on secondary electrons from gamma decay [1].

Normally, cobalt and cadmium are used prompt emitters in the EPR detector systems. For example, considering the physics of reaction in an EPR Co-SPND, we have the neutron absorption in the  $^{59}\text{Co}$  (with a 37 barn cross section) and the subsequent beta decay of the  $^{60}\text{Co}$ :

- 1)  $^{59}\text{Co}(n,\gamma)^{60}\text{Co}$ : the electron produced by the gamma interaction (photoelectric and Compton effect) constitute the prompt signal which is over 90% of the global current signal;
- 2)  $^{60}\text{Co} \rightarrow ^{60}\text{Ni} + \gamma + \beta^-$ : the decay electrons and the electron produced by the gamma interactions gives ionization and form the delayed current signal.

Thus, the cobalt emitter is a prompt neutron detector with a fast response to changes in the neutron flux. The corresponding burn-up rate is 0.094%/month in a thermal neutron flux of  $10^{13} \text{ n}/(\text{cm}^2\text{s})$ . Moreover, the instrument requires a long-term compensation due to build-up of the isotopes  $^{60}\text{Co}$  and  $^{61}\text{Co}$ : in some specially designed detectors the electronic systems permits to automatically correct for the build-up of the  $^{60}\text{Co}$  activity.

## 2. EPR in-core instrumentation

In the EPR, the fixed in-core instrumentation consists of neutron detectors and thermocouples to measure the neutron flux radial and axial distribution in the core, and temperature radial distribution at the core outlet, respectively.

The core outlet thermocouples measure the fuel assembly outlet temperature and provide signals for core monitoring in case of loss-of-coolant event; they also provide information on radial power distribution and thermal-hydraulic local conditions. Relying on temperature measurements in the cold and hot legs of the four primary loops, a quadruple-redundant primary heat balance is achieved and complemented by neutron flux measurements with very short response time.

Prediction and measurement of the three-dimensional power distribution relies on two types of in-core instrumentation [2]:

- “movable” reference instrumentation validates the core design and calibrates other core surveillance and protection sensors;
- “fixed” instrumentation delivers online information to the surveillance and protection systems, which actuate appropriate actions and countermeasures in case of anomalies or exceeding of predefined limits.

The movable reference instrumentation for power distribution assessment is an “aeroball” system (Fig. 5). Stacks of vanadium-alloy balls, inserted from the top of the pressure vessel, are pneumatically transported into the reactor core inside guide thimbles of fuel assemblies, then, after 3 minutes, to a bench where the activation of each probe is measured at 30 positions in 5 minutes. This gives values of the local neutron flux in the core that are processed to determine the three-dimensional power distribution map.

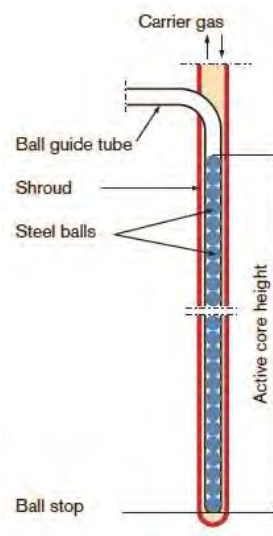

Figure 5: Aeroball system for EPR [2].

The arrangement of the in-core detectors is sketched in Fig. 6: each channel contains 6 detectors for a global number of 72 detectors.

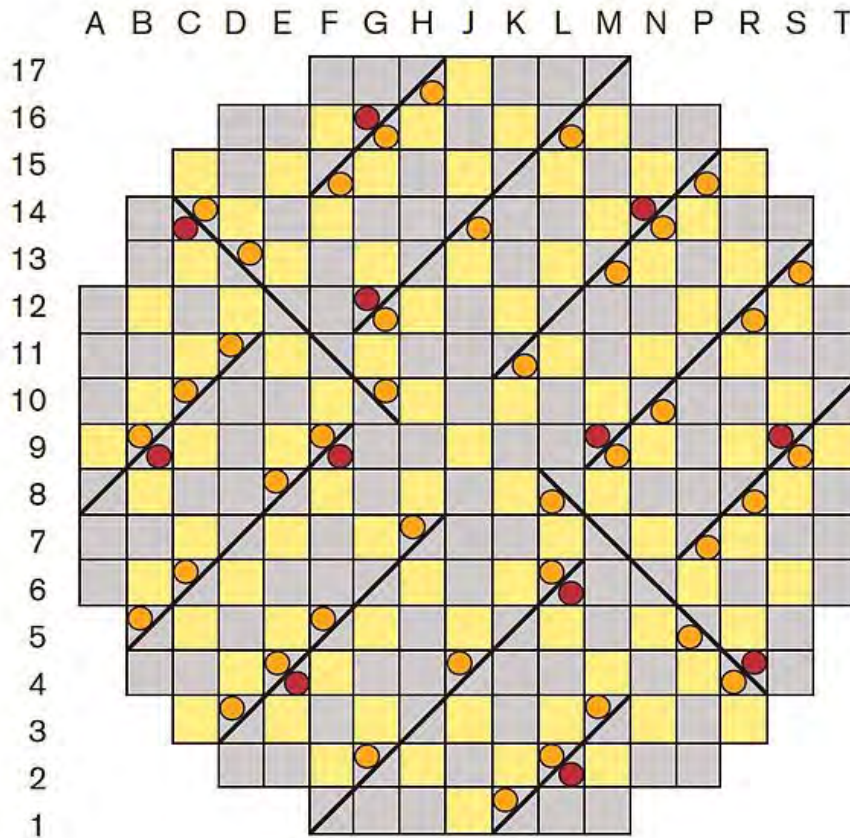

Figure 6: EPR core cross section formed of 241 fuel assemblies, 89 control rods (yellow squares), 12 in-core detectors (red circles), 40 aeroball probes (yellow circles) [2].

### 3. Monte Carlo reliability analysis of SPNDs

The SPND belong to the reactor safety system, so their simplicity and reliability are crucial elements. Nevertheless, as with other detectors, there is a finite probability of failure of the detectors. Most of the observed failures are “hard” failures, which developed primarily within less than one hour and are attributable to moisture-induced loss of cable insulation or, in a minor part, to cable lead breach. The other kind of failures (so called “soft type”) develop gradually during the reactor operation and lead to sensitivity losses or build-up of excessive background signals. Such

failures do not compromise plant availability, but they can determine errors in the neutron flux evaluation. A sum of soft errors can be considered equivalent to a hard error.

In the present work, we considered hard failures that determine the malfunction of the detector. The object of the work was evaluating if the SPND system can guarantee a functional reliability even if the individual detectors perform imperfectly. The two main design principles adopted for SPNDs can help to this purpose:

- in-situ calibration capability, allowing detector signals to be checked at any time, greatly aiding detector performance assessment
- redundancy allowing part of the SPNDs to be dispensed with if the need should arise.

As explained in the introduction, we assumed a known failure rate considering the cumulative experience with SPNDs in German 1300 MWe plants which shows a failure rate of typically 2% per operating year. The assumed EPR positions of the SPND instrumentation are shown in Fig. 6.

### *3.1 Description of the Monte Carlo method*

The SPND-EPR system reliability is simulated with an ad-hoc Monte Carlo code. It is assumed that the reliability values for each detector is known: the rate of failure is assumed to be 2%/year as with German PWRs [2]. Each detector can be considered an independent system: the failure of a detector is assumed to be independent on the failure of the other in-core detectors. The flexibility of the code permit to manage also situations in which the failure of one detector can influence the answer of the other detectors: the system is more complex but the method can work the same way. Using a known component reliability, with the Monte Carlo code it is possible to evaluate the reliability of the entire detector system.

The Monte Carlo method generates random failure times from each detector's failure distribution probability. Generating a large number of these configurations, for the central limit theorem, the EPR detector system reliability is obtained with the Monte Carlo simulation.

In a first simple case, the probability for each detector to fail at a time  $t$  is the product of the probability to survive up to the time  $t$  multiplied by the probability to fail in the interval between  $t$  and  $t + dt$ . This is assumed to be:

$$p(t) = \frac{1}{\tau} e^{-t/\tau} \quad (2)$$

where  $\tau$  is the average life of each detector, calculated as the inverse of the number of failure in a considered period, one year in the present case (for example, if the failure rate is 2% at year, the

average life of each detector is 50 years). From equation (2) it is possible to calculate the cumulative probability as follows:

$$P(t) = \int_0^t p(t) = \frac{1}{\tau} \int_0^t e^{-t/\tau} = 1 - e^{-t/\tau} \quad (3)$$

which represents the probability to have a failure time shorter than  $t$ . It is easy to verify the normalization condition:

$$P(\infty) = 1 \quad (4)$$

Now considering a random number uniformly distributed between 0 and 1, we can write:

$$P(t) = 1 - e^{-t/\tau} = r \quad (5)$$

from which we obtain the failure time:

$$t = -\tau \log(1 - r) \quad (6)$$

If the failure time is shorter than the time increment, a failure will be counted. The same method can be used without any restrictions for the probability distribution functions of other types of detector failure.

### 3.2 Monte Carlo reliability simulation procedure

The code comprises an inner loop and an outer loop of iterations: each inner loop iteration corresponds to the generation of a random number for one of the  $N_d = 72$  detectors, i.e. the determination of the failure time of the detectors. For each inner loop, the number of failure in the considered period is evaluated. The number of outer loops  $N_e$  is the number of repetitions of the inner loop: it corresponds to the number of simulation points to be generated for each component. By repeating the cycle (outer loop) a large number of times, the number of failure in the considered period is calculated.

The simulation procedure is composed of the following steps:

- 1) selection of the number of outer loops (Monte Carlo iteration);
- 2) start of the internal loop: generation of a random number for each detector;

- 3) calculation of the failure time for each detector;
- 4) comparison between the failure time of each detector and the operating time: determination of the number of failures in the considered time interval and which components failure;
- 5) calculation of the reliability for the loop as a ratio between the number of failure  $N_{fail,i}$  and the number of detectors:

$$p_i = \frac{N_{fail,i}}{N_d} \quad (7)$$

- 6) return to step 2 and repeat the external loop for the desired number of cycles;
- 7) calculation of the system failure probability as the average failure probability in the outer loops:

$$p = \frac{1}{N_e} \sum_{i=1}^{N_e} p_i \quad (8)$$

- 8) The reliability  $r$  represent the success probability so it can be expressed as:

$$r = 1 - p \quad (9)$$

and it is a number between 0 and 1 (that can be multiplied by 100 to be expressed in percentage).

In Fig. 7 an application of the code to the calculate the reliability of the EPR-SPND system for fixed interval times (one year in the present case) and for a fixed end time of the reactor (30 years) is shown. As can be seen from Fig. 7, the overall reliability is strongly dependent on the failure rate of each detector. The parameter of the calculations can be freely changed and also different detectors reliabilities can be considered.

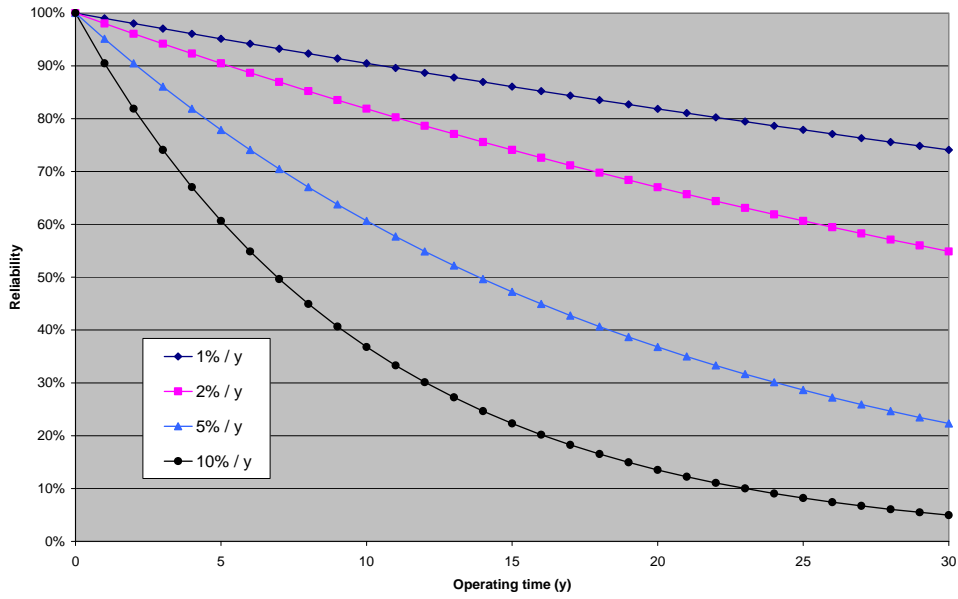

Figure 7: SPND-EPR reliability vs. operating time for different reliability of each detector.

The developed code contains the geometrical positions of the SPNDs of the EPR. Assuming stationary conditions, the neutron flux at each detector position can be evaluated with the following formula (for a cylindrical reactor with height  $H$  and radius  $R$ ):

$$\Phi = \Phi_0 J_0 \left( \frac{2.405r}{R} \right) \cos \frac{\pi z}{H} \quad (10)$$

The developed code is characterized by high flexibility in the reliability evaluation of the overall system:

- each detector can be characterized by a specific failure rate;
- a Gaussian distribution function of the detector measurements can be considered and the corresponding effect on the system reliability can be evaluated. For example, a soft failure can be considered when the error is higher than a fixed threshold; a sequence of a certain number of soft errors can be assumed to be equivalent to a hard failure;
- considering the localized neutron flux  $F$  as a time dependent stochastic process and knowing the increment of the instrument error reading after a device failure, it is possible to evaluate the reliability of the system and the variation of the error with time.

As found in previous studies [2], for a given perturbation the power shape perturbation profile of the reactor is not strictly dependent on the core status (loading pattern, burn-up, etc.). Thus the

tracking accuracy of the SPNDs, i.e. the error in the evaluation of the reactor power or in the evaluation of LPD (Local Power Distribution) and DNBR (Departure from Nuclear Boiling Ratio), is a property of the monitoring system itself .

## **Bibliography**

- [1] Knoll G.F., *Radiation detection and measurements*, John Wiley & Sons, 1989.
- [2] Düweke C., Thillosen N., Ziethe J., *Neutron flux incore instrumentation of AREVA's EPR<sup>TM</sup>*, First International Conference on "Advancements in Nuclear Instrumentation Measurement Methods and their Applications (ANIMMA)", 7-10 June 2009, pages 1-6, IEEE 2009.

**Appendix. Fortran subroutine to produce random numbers uniformly distributed in the (0,1) interval**

```
DOUBLE PRECISION FUNCTION RAN1(ISEED)
IMPLICIT DOUBLE PRECISION (A-H,O-Z)
C IF ISEED < 0 THERE IS AN INIZIALIZATION OF THE RANDOM SEQUENCE EACH
TIME THE MAIN PROGRAM CALLS THE FUNCTION
DIMENSION R(97)
PARAMETER (M1=259200,IA1=7141,IC1=54773,RM1=1.0D0/M1)
PARAMETER (M2=134456,IA2=8121,IC2=28411,RM2=1.0D0/M2)
PARAMETER (M3=243000,IA3=4561,IC3=51349)
DATA IFF /0/

IF (IDUM.LT.0.OR.IFF.EQ.0) THEN
  IFF=1
  IX1=MOD(IC1-IDUM,M1)
  IX1=MOD(IA1*IX1+IC1,M1)
  IX2=MOD(IX1,M2)
  IX1=MOD(IA1*IX1+IC1,M1)
  IX3=MOD(IX1,M3)

  DO 11 J=1,97
    IX1=MOD(IA1*IX1+IC1,M1)
    IX2=MOD(IA2*IX2+IC2,M2)
    R(J)=(FLOAT(IX1)+FLOAT(IX2)*RM2)*RM1
  11 CONTINUE

ENDIF

IX1=MOD(IA1*IX1+IC1,M1)
IX2=MOD(IA2*IX2+IC2,M2)
IX3=MOD(IA3*IX3+IC3,M3)
J=1+(97*IX3)/M3
IF (J.GT.97.OR.J.LT.1) PAUSE
RAN1=R(J)
R(J)=(FLOAT(IX1)+FLOAT(IX2)*RM2)*RM1

RETURN
END
```