



Agenzia Nazionale per le Nuove Tecnologie,
l'Energia e lo Sviluppo Economico Sostenibile



Ministero dello Sviluppo Economico

RICERCA DI SISTEMA ELETTRICO

Specifiche tecniche per la realizzazione degli switching network unit
dei solenoidi centrali del tokamak JT-60SA

Alessandro Lampasi



SPECIFICHE TECNICHE PER LA REALIZZAZIONE DEGLI SWITCHING NETWORK UNIT DEI SOLENOIDI CENTRALI DEL TOKAMAK JT-60SA

Alessandro Lampasi (ENEA)

Novembre 2011

Report Ricerca di Sistema Elettrico

Accordo di Programma Ministero dello Sviluppo Economico – ENEA

Area: Governo, gestione e sviluppo del sistema elettrico nazionale

Progetto: Fusione nucleare: Attività di fisica e tecnologia della fusione complementari ad ITER, denominate "Broader Approach"

Responsabile Progetto: Aldo Pizzuto, ENEA

Sommario

Lista delle tabelle	5
Lista delle figure	5
Acronimi, termini e definizioni (in lingua originale).....	6
1 Obiettivi del rapporto e delle attività.....	10
2 Descrizione funzionale del sistema di alimentazione di JT-60SA	12
3 Il ruolo dello SNU negli scenari di corrente	13
4 Lo schema di riferimento ibrido	15
5 Introduzione alle specifiche tecniche degli switching network unit	15
6 Scope of the Procurement.....	15
6.1 Warranty.....	16
7 Functional description of the JT-60SA power supply system	16
7.1 Overall description of the power supply system	17
7.1.1 Overview of the poloidal field (PF) coil power supply.....	17
7.1.2 Role of the SNU in a current scenario	19
7.1.3 Other coil power supplies.....	19
8 SNU specifications and requirements	20
8.1 SNU basic scope.....	20
8.2 SNU functional parameters and operating mode	21
8.3 Control strategy.....	22
8.4 SNU cooling system	24
8.5 Layout and installation requirements	25
8.6 Enclosures.....	25
8.7 Interfaces.....	26
8.7.1 General	26
8.7.2 Interface with the DC power and the coil	26
8.7.3 Interface with the low voltage distribution system	26
8.7.4 Interfaces with the fluids systems.....	27
8.7.5 Interface with the grounding grid	27
8.7.6 Interfaces with the building.....	27
8.7.7 Interfaces with PS SC, SCSDAS, GPS and SIS	27
8.8 SNU reference scheme	28
8.8.1 Typical operation sequence of the reference scheme	28
8.9 Requirements on the SNU main components.....	29
8.9.1 By-pass switch (BPS).....	29
8.9.2 Static circuit breaker (SCB)	30
8.9.3 Breakdown resistors.....	31
8.9.4 Power connections	31
8.9.5 Grounding connections	31



Italian National Agency
for New Technologies,
Energy and Sustainable
Economic Development



UTFUS
Fusion
EURATOM-ENEA
Association

Report Ricerca di Sistema Elettrico
Accordo di Programma Ministero dello Sviluppo Economico:
Specifiche tecniche per la realizzazione degli switching network
unit dei solenoidi centrali del tokamak JT-60SA

ENEA ID:
RT-JT60-SA-007

Page: **4/37**

Autore:
Alessandro Lampasi

Rev. **0**
Nov 2011

8.9.6	Safety grounding switches.....	31
9	Testing and approval requirements	32
10	Packing and transport requirements.....	33
11	Identification and traceability requirements	33
12	Documentation to be supplied.....	33
13	Training.....	33
14	Site conditions	34
14.1	Ambient conditions	34
14.2	Seismic events (only for information)	34
14.3	Facilities in the PS buildings.....	34
15	Quality assurance documents	34
16	International standards	35
17	Annexed drawings	36
18	Annexed documents.....	36
19	Reference documents.....	37

Liste delle tabelle

Table 1: Caratteristiche dei resistori degli SNU, determinanti per fissare i limiti delle prestazioni.	14
Table 2: Main components of the SNU (see Fig. 4-1 of the technical specifications).	14
Table 3: Specifications for Base/Booster PSs and SNU for CS1-4 and EF1-6 [ANX1].	18
Table 4: Main parameters of the SNU.	21
Table 5: List of signals transferred to/from LCC from/to PS SC.	23
Table 6: Auxiliary voltages for the four CS SNU.	27
Table 7: Basic technical data of the BPS (see also Table 4).	30
Table 8: Basic technical data of the SCB (see also Table 4).	30

Liste delle figure



Fig. 1: Schema delle alimentazioni degli avvolgimenti CS1, CS2, CS3 e CS4.	11
Fig. 2: Schema funzionale di uno SNU.	12
Fig. 3: Esempio di scenario di corrente per un CS. La fase di break down è ingrandita per enfatizzare il ruolo dello SNU.	13
Fig. 4: Schema di riferimento ibrido proposto (schermata di un modello di simulazione).	14
Fig. 6: Schematic diagram of the AC PS for JT-60SA [ANX1].	17
Fig. 7: Schematic of the TF coil circuit configuration [ANX1].	19
Fig. 8: Example of switching operations in the hybrid scheme. At the breakdown, the current abruptly decreases with two different slopes due to the SNU resistors R1 and R2.	29

Acronimi, termini e definizioni (in lingua originale)



Acronym	Term	Definition
AoC	Agreement of Collaboration	Framework between F4E and VC-DI to reinsure its commitments towards JAEA under the Procurement Arrangements
–	Annex	Drawings and documents considered as integrant parts of this Technical Specifications and provided to the potential ISs during the Call for Tender
BA	Broader Approach	Agreement between the Government of Japan and the European Atomic Energy Community for the joint implementation of the activities in the field of fusion energy research
BPS	By-Pass Switch	Electromechanical device that conducts the coil current before and after the breakdown phase in the reference scheme
CBU	Crow-bar Unit	Electrical circuit used to prevent an overvoltage of a power supply
CRL	Current Reversing Link	Links inserted in the PSs to reverse the polarity of the magnetic field
CS	Central Solenoid	Nb ₃ Sn conductor consisting of 4 independent modules
CT	Current Transducer	Transducers for current measurements in the SNU
–	Customer	VC-DI responsible for handling financially and legally the Procurement of its in-kind contributions: for this Procurement, the Customer is ENEA
DDP	Detailed Design Phase	In this phase, the ISs shall detail the technical solutions selected to comply with the requirements
DEMO	DEMO	DEMONstration Power Plant intended to build upon the success of ITER
DMS	Document Management System	BA Document Management System (also known as IDM)
ECRF	Electron Cyclotron Radio-Frequency	Electron Cyclotron Radio-Frequency system for additional heating
EF	Equilibrium Field	Equilibrium Field (coil)
EMC	Electromagnetic Compatibility	Correct operation of different objects in the same electromagnetic environment
ENEA	ENEA	Italian National Agency for New Technologies, Energy and Sustainable Economic Development
EU	EU	Europe

F4E	Fusion for Energy	European joint undertaking for ITER and the Development of Fusion Energy: integral part of the JT-60SA Project EU Home Team ensuring the coordination of implementation of the PA and its interfaces with other PAs in BA activities
FPGA	Field Programmable Gate Array	Integrated circuit designed to be configured by the customer or designer after manufacturing
FPPC	Fast Plasma Position Control	Coils used to control the plasma position
GPS	Global Protection System	System for handling the protection signals received from the equipment and distributing the protection commands
GS	Grounding Switch	Switches for SNU safety grounding
HMI	Human Machine Interface	Hardware/software to for friendly high-level management
IAs	Implementing Agencies	F4E and JAEA
IDC	Identification Code	Code used for identification and traceability of JT-60SA components
IGCT	Integrated Gate Commutated Thyristor	Power semiconductor electronic device used to switch electric current
IP code	International Protection code	International Protection rating code as defined in Standard IEC 60529
IPS	Internal Protection System	System to coordinate protective actions among all JT-60SA PS components and among them and the remaining parts of the JT-60SA system
IS	Industrial Supplier	The company selected by ENEA to provide the supplies, services or works described in these Technical Specifications, according to a Procurement Contract
ITER	International Thermonuclear Experimental Reactor (ITER)	International research and engineering project which is currently building the world's largest and most advanced experimental tokamak nuclear fusion reactor
JA JAEA	Japan Japan Atomic Energy Agency	-
JT-60SA	JT-60SA	JT-60 Super Advanced tokamak, the construction and exploitation of which shall be conducted under the Satellite Tokamak Programme and the Japanese national programme
LCC	Local Control Cubicle	SNU Local Control Cubicle
LCM	Local Control Mode	Local Control Mode of the SNU operations
LSOHFR	Low Smoke, Zero Halogen, Fire Retardant	Type of insulation for cables and optical fibers
MS	Making Switch	Switch able to insert the second resistance R2 to support the plasma breakdown phase
NBI	Neutral Beam Injector	Positive (P-NBI) and negative (N-NBI) neutral beam injectors for additional heating

PF	Poloidal Field (coil)	In a tokamak, the poloidal field travels in circles orthogonal to the toroidal field
PID	Plant Integration Document	Document defining the technical basis of the JT-60SA Project
PoE	Port of Entry	Port of Entry in Japan
PA	Procurement Arrangement	Framework between F4E and JAEA for the main governing, financial and collaborative requirements for the supply of a procurement package
PS	Power Supply	–
PS SC	Power Supply Supervising Computer	Computer provided by JAEA that communicates with SCSDAS, GPS and SIS and includes an IPS
PSV	Vertical power supply	Vertical field coil power supply already present in JT-60U
QPC	Quench Protection Circuit	System to protect superconducting coils
RCM	Remote Control Mode	Remote Control Mode of the SNU operations
RM	Reflective Memory	Real-time Local Area Network in which each computer always has an up-to-date local copy of the shared memory set
rms	Root Mean Square	Standard Parameter of an alternating electrical quantity
RWM	Resistive Wall Mode	Issue related to plasma stabilization
SCB	Static Circuit Breaker	Switch system based on static devices that supports the BPS to satisfy the time specifications
SCSDAS	Supervisory Control System and Data Acquisition System	JT-60SA system
SIS	Safety Interlock System	JT-60SA system
Site, Naka Site	–	The location where the system object of these technical specifications will be installed: Naka, Japan
SNU	Switching Network Unit	The main object of this Procurement
SS	Fast SNU Switch	Functional component of a SNU, that can be implemented by several physical devices, able to divert the coil current to a specific set of resistors
STP	Satellite Tokamak Programme	One of the three projects in the BA activities with the purpose to develop JT-60SA
TF	Toroidal Field (coil)	In a tokamak, the toroidal field travels around the torus in circles
–	Tokamak	Device using a magnetic field to confine a plasma in the shape of a torus
UID	Unique Identifier	Code identifying a DMS document with current status, version, and so on
VC-DI	Voluntary Contributor Designated Institution	Institution appointed by the Government of the countries (Voluntary Contributors) that give voluntary contributions to

 <i>Italian National Agency for New Technologies, Energy and Sustainable Economic Development</i>	 UTFUS <i>Fusion EURATOM-ENEA Association</i>	Report Ricerca di Sistema Elettrico Accordo di Programma Ministero dello Sviluppo Economico: Specifiche tecniche per la realizzazione degli switching network unit dei solenoidi centrali del tokamak JT-60SA	ENEA ID: RT-JT60-SA-007	Page: 9/37
			Autore: Alessandro Lampasi	Rev. 0 Nov 2011

		Euratom for the implementation of the BA activities
XFMR	Transformer	–

 Italian National Agency for New Technologies, Energy and Sustainable Economic Development	 UTFUS Fusion EURATOM-ENEA Association	Report Ricerca di Sistema Elettrico Accordo di Programma Ministero dello Sviluppo Economico: Specifiche tecniche per la realizzazione degli switching network unit dei solenoidi centrali del tokamak JT-60SA		ENEA ID: RT-JT60-SA-007	Page: 10/37
				Autore: Alessandro Lampasi	Rev. 0 Nov 2011

1 Obiettivi del rapporto e delle attività

Il presente rapporto presenta le attività svolte nell'ambito della Ricerca di Sistema Elettrico per il Piano Annuale di Realizzazione (PAR) 2010 dell'Obiettivo A.3 (Progettazione degli "switching network unit") dell'Accordo di Programma tra Ministero dello Sviluppo Economico ed ENEA (Area: Governo, gestione e sviluppo del sistema elettrico nazionale. Progetto: Fusione nucleare: Attività di fisica e tecnologia della fusione complementari ad ITER, denominate "Broader Approach").

Lo scopo principale delle attività presentate in questo rapporto consiste nella realizzazione degli switching network unit dei solenoidi centrali del tokamak JT-60SA situato a Naka in Giappone.

JT-60SA è un progetto "satellite" frutto della collaborazione tra Unione Europea e Giappone nell'ambito dell'accordo internazionale denominato Broader Approach (BA), la cui finalità principale è di fornire indicazioni utili per lo sviluppo e le operazioni dei progetti internazionali ITER e DEMO. Il tokamak JT-60SA è un aggiornamento superconduttore ("super, advanced") del preesistente tokamak denominato JT-60.

Una descrizione dettagliata della macchina JT-60SA e dei suoi sistemi ausiliari è fornita dal Plant Integration Document (PID) [ANX1], un documento ufficiale aggiornato periodicamente dal gruppo di ricerca internazionale coinvolto nel progetto.

L'accordo BA stabilisce che alcune nazioni europee, tra cui l'Italia, contribuiscono "volontariamente" (Voluntary Contributor, VC) alle tecnologie ed agli esperimenti di JT-60SA. Ogni contributo al sistema è regolato da un Agreement of Collaboration (AoC) tra l'agenzia europea Fusion for Energy (F4E) e l'ENEA finalizzato all'attuazione congiunta del Procurement Arrangement (PA) per la realizzazione del Satellite Tokamak Programme.

In questo scenario, l'ENEA ha il compito di fornire 4 switching network unit (SNU) per gli alimentatori dei 4 solenoidi centrali (CS1, CS2, CS3 e CS4) di JT-60SA. A questo scopo, l'ENEA ha elaborato le specifiche tecniche e gli altri documenti necessari alla realizzazione ed alla integrazione finale degli SNU. In seguito, in conformità di queste informazioni, l'ENEA selezionerà e supervisionerà un fornitore industriale (Industrial Supplier, IS). Inoltre, mediante procedure indipendenti, l'agenzia giapponese JAEA acquisterà altri 2 SNU per gli avvolgimenti EF3 e EF4 degli Equilibrium Field (EF) coil, con caratteristiche simili a quelle stabilite per gli SNU dei CS.

Le prime sezioni di questo rapporto presentano le funzionalità generali di una SNU ed il suo ruolo negli esperimenti sul plasma finalizzati alla fusione nucleare. In principio, uno SNU può essere visto come un interruttore per la corrente continua che inserisce molto rapidamente un resistore nel circuito di alimentazione allo scopo di produrre l'alta tensione necessaria al breakdown ed alla formazione del plasma. È utile rilevare che le prestazioni non comuni richieste agli SNU (in termini di corrente, tensione, tempi di intervento) non possono essere ottenute mediante dispositivi commerciali esistenti e richiedono quindi un progetto specifico basato su configurazioni innovative.

Le specifiche tecniche e i disegni schematici per la realizzazione dei 4 SNU dei solenoidi centrali di JT-60SA costituiscono i principali risultati/deliverable delle attività del PAR nel periodo considerato (dicembre 2010 – novembre 2011). Questi risultati sono presentati nella seconda parte di questo rapporto.

I disegni di layout o comunque relativi ad edifici, strutture e servizi di JT-60SA sono stati discussi e concordati con F4E e JAEA e possono esistere diverse versioni adattate alle esigenze di ciascuna agenzia. I disegni forniti ai potenziali fornitori come allegato alle specifiche tecniche sono elencati nella Sezione 17 del presente rapporto.

Poiché le specifiche tecniche presentate sono state scritte in esecuzione dell'AoC tra F4E e l'ENEA finalizzato all'attuazione congiunta del PA relativo, esse sono state discusse con i partner europei e giapponesi e sono state ufficialmente approvate da F4E. Proprio perché destinate ad interlocutori stranieri, le specifiche tecniche e i disegni sono stati redatti in lingua inglese e saranno riportate in lingua originale.

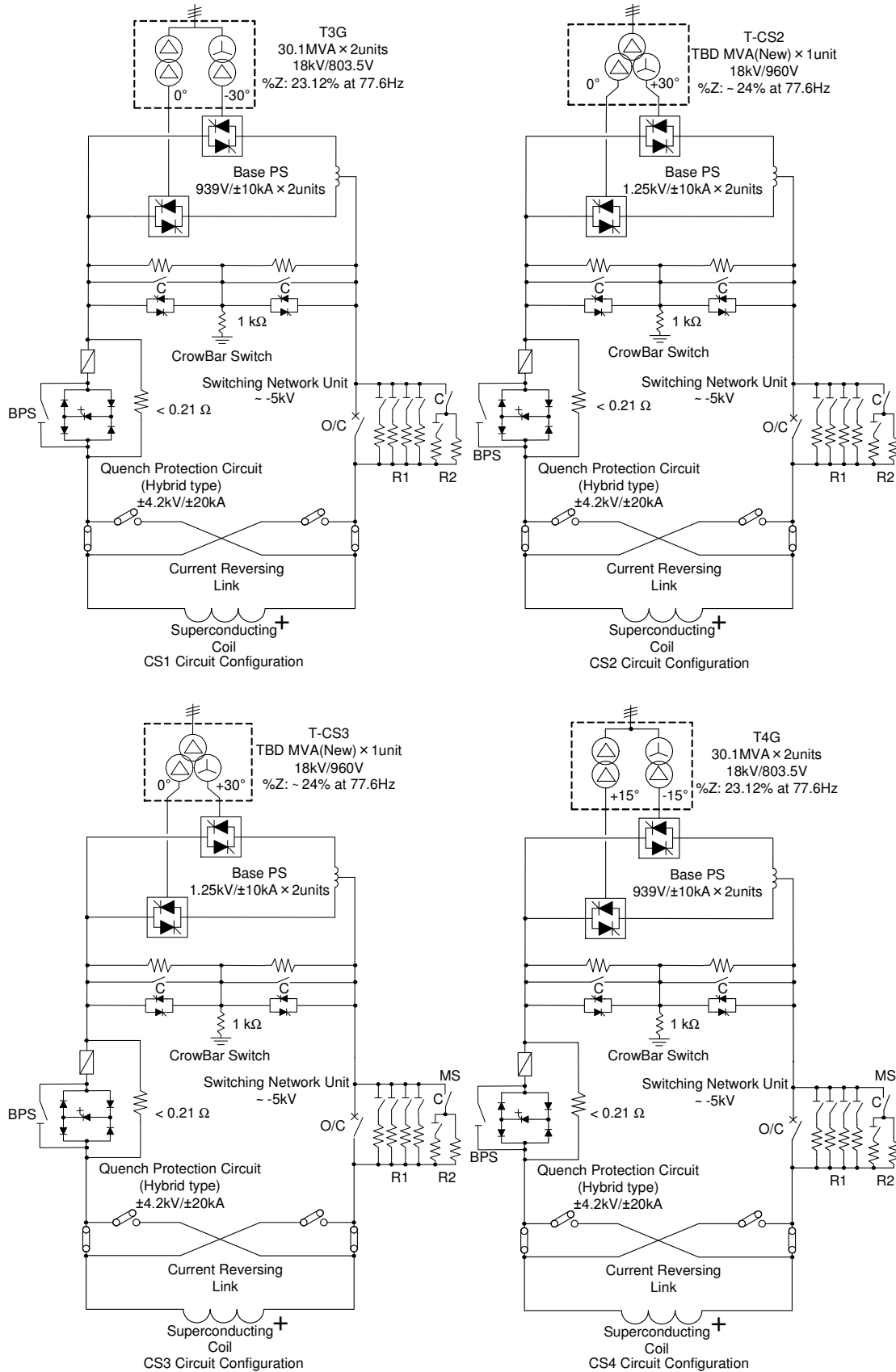

Fig. 1: Schema delle alimentazioni degli avvolgimenti CS1, CS2, CS3 e CS4.

2 Descrizione funzionale del sistema di alimentazione di JT-60SA

Le alimentazioni elettriche (power supply, PS) degli avvolgimenti di un tokamak devono essere in grado di fornire una corrente continua regolabile in grado di riprodurre gli scenari di corrente desiderati e determinati dalla fisica dell'esperimento in corso.

Fig. 1 schematizza l'ultima versione ufficiale del circuito di alimentazione dei CS [ANX1]. In particolare, sono mostrati i seguenti elementi funzionali:

- Trasformatori di potenza (anche per ragioni di economicità, gli accordi internazionali prevedono di riutilizzare per quanto possibile i trasformatori esistenti in JT-60);
- Convertitori AC/DC a tiristori a 4 quadranti (Base PS);
- Crow-bar (circuito di protezione, soprattutto per le sovratensioni);
- SNU;
- Quench protection circuit (QPC) che scarica l'energia magnetica accumulata nel superconduttore in caso di quench del superconduttore stesso o in caso di altri guasti o spegnimenti;
- Current reversing link (CRL) per consentire operazioni con un capo magnetico toriodale di polarità inversa;
- Avvolgimenti a superconduttori.

Lo schema funzionale di uno SNU è illustrato in Fig. 2. Il fornitore IS è libero di proporre delle scelte progettuali per la realizzazione di questo schema di principio. La soluzione finale sarà accettata dall'ENEA durante la fase di progetto dettagliata (Detailed Design Phase, DDP). L'ENEA, in accordo con i partner internazionali, ha comunque elaborato uno schema di riferimento che verrà illustrato nel seguito.

Ogni SNU fornita consiste in un interruttore veloce principale (SS), un making switch (MS), due set di resistori di break down (R1 e R2) regolabili tramite i relativi selettori, due interruttori di sicurezza per la messa a terra (GS). Inoltre, deve essere supportata da ogni sistema di controllo, protezione, misura, raffreddamento necessario al suo funzionamento.

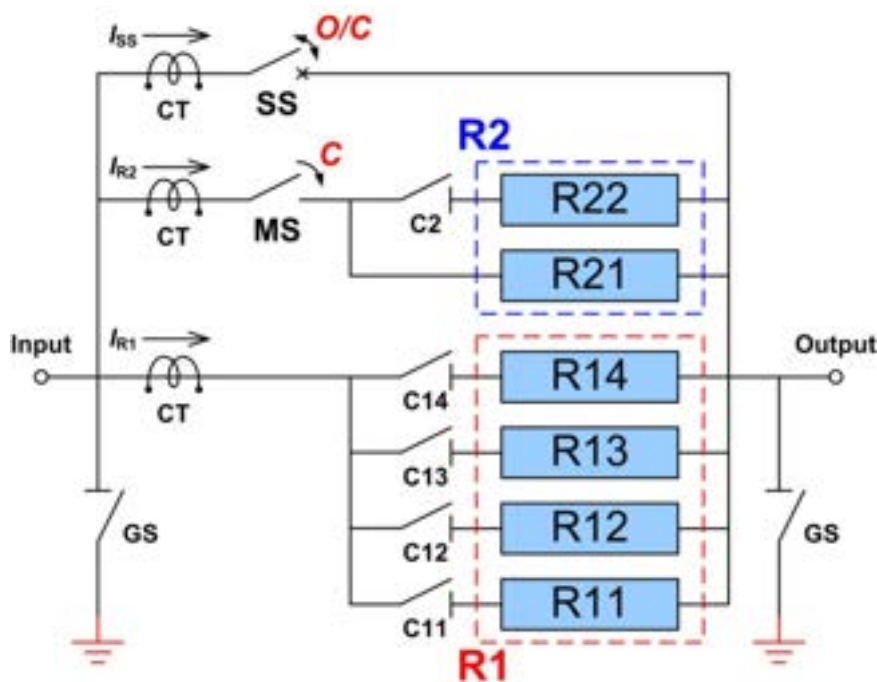

Fig. 2: Schema funzionale di uno SNU.

3 Il ruolo dello SNU negli scenari di corrente

Fig. 3 schematizza uno “scenario” di corrente (andamento della corrente in funzione del tempo) tipico di un CS, enfatizzandone alcune fasi salienti.

Generalmente, gli scenari di corrente di un tokamak prevedono una prima fase caratterizzata da una lenta salita (ramp-up) della corrente prodotta dal convertitore a tiristori (Base PS), fino a un massimo valore prestabilito (inferiore a 20 kA nel caso dei CS). Quando questo valore è stato raggiunto, lo SNU, inserendo una opportuna resistenza R1 in serie all’avvolgimento, produce una brusca derivata di corrente che non potrebbe essere sostenuta dal solo convertitore a tiristori. Tale derivata di corrente induce la necessaria tensione toroidale nel plasma.

Dopo l’avvio del plasma (tipicamente dopo qualche decina di millisecondi), lo scenario può richiedere una seconda fase di funzionamento dello SNU in cui la derivata di corrente è meno ripida. Questa variazione viene ottenuta inserendo, tramite il MS, una seconda resistenza R2 in parallelo a R1 che riduce la resistenza equivalente in serie all’avvolgimento.

I valori delle resistenze R1 and R2 (resistenze di breakdown) possono essere cambiati pre-selezionando (prima dell’inizio dell’esperimento), tramite i selettori C2, C11, C12, C13 and C14 mostrati in Fig. 2, un’opportuna combinazione di resistori. Questo consente di cambiare le cadute di tensione ai capi delle resistenze e quindi le caratteristiche degli scenari di corrente.

Quando la corrente di plasma ha raggiunto il valore desiderato, lo SNU può cortocircuitare i resistori tramite l’interruttore SS, escludendoli di fatto dal sistema per il resto dello scenario che può durare fino a 250 s con una ripetizione dopo 1800 s e con esperimenti per circa 10 ore al giorno.

È importante sottolineare che le caratteristiche dei resistori (soprattutto la massima energia dissipabile da essi), fissate dagli accordi internazionali e riportate in Table 1, sono in pratica il limite delle capacità di tutta lo SNU. Su di essi dovrebbe essere regolato il tempo massimo di funzionamento dello SNU e dei suoi componenti. In pratica, lo SNU può operare al massimo pochi secondi per una corrente di scenario positiva.

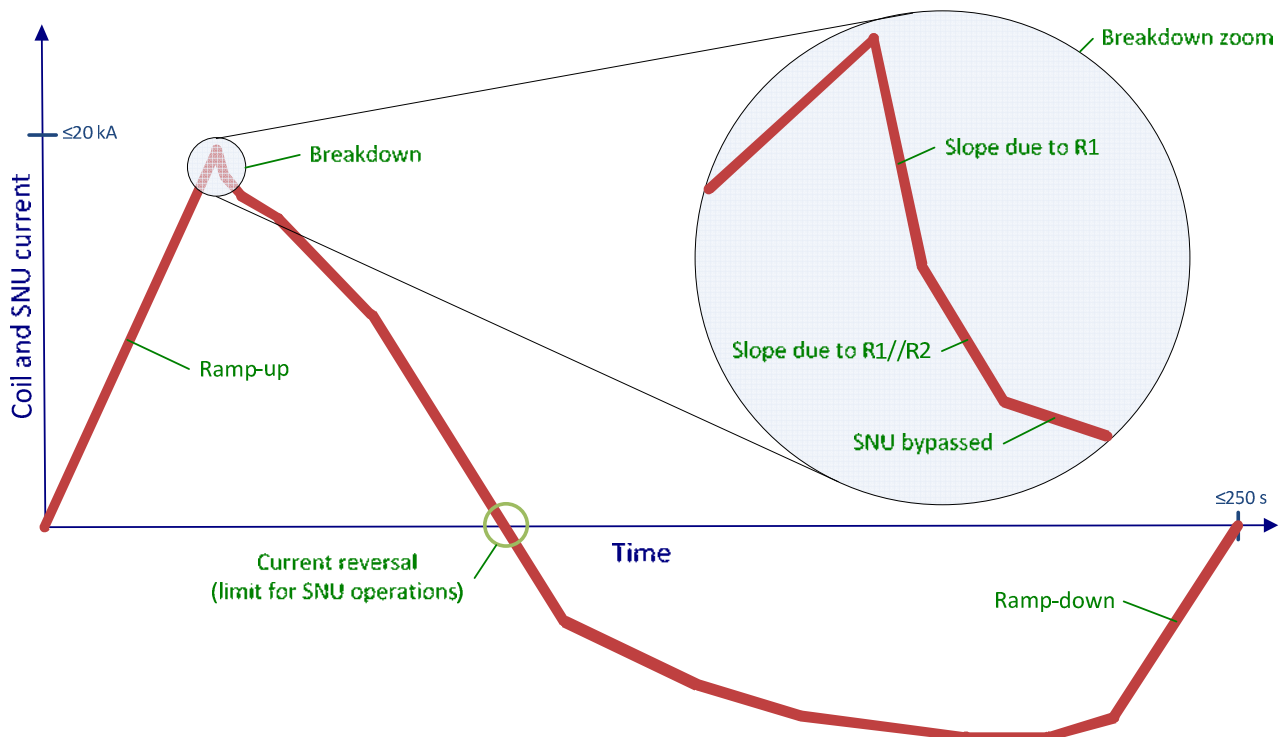

Fig. 3: Esempio di scenario di corrente per un CS. La fase di break down è ingrandita per enfatizzare il ruolo dello SNU.

Table 1: Caratteristiche dei resistori degli SNU, determinanti per fissare i limiti delle prestazioni.

Item	Resistance	Rated Current	Dump Energy		Max voltage	Voltage (IEC 60071)	
R1	R14	3.75 Ω	1.333 kA		2 MJ	5 kV DC	7.2 kV rms
	R13	1.875 Ω	2.667 kA		4 MJ	5 kV DC	7.2 kV rms
	R12	0.9375 Ω	5.333 kA		8 MJ	5 kV DC	7.2 kV rms
	R11	0.4688 Ω	10.667 kA		16 MJ	5 kV DC	7.2 kV rms
R2	R21	0.05 Ω	10.0 kA	CS1, CS4	CS2, CS3	5 kV DC	7.2 kV rms
				30 MJ	20 MJ		
	R22	0.05 Ω	10.0 kA	CS1, CS4	CS2, CS3	5 kV DC	7.2 kV rms
				30 MJ	20 MJ		

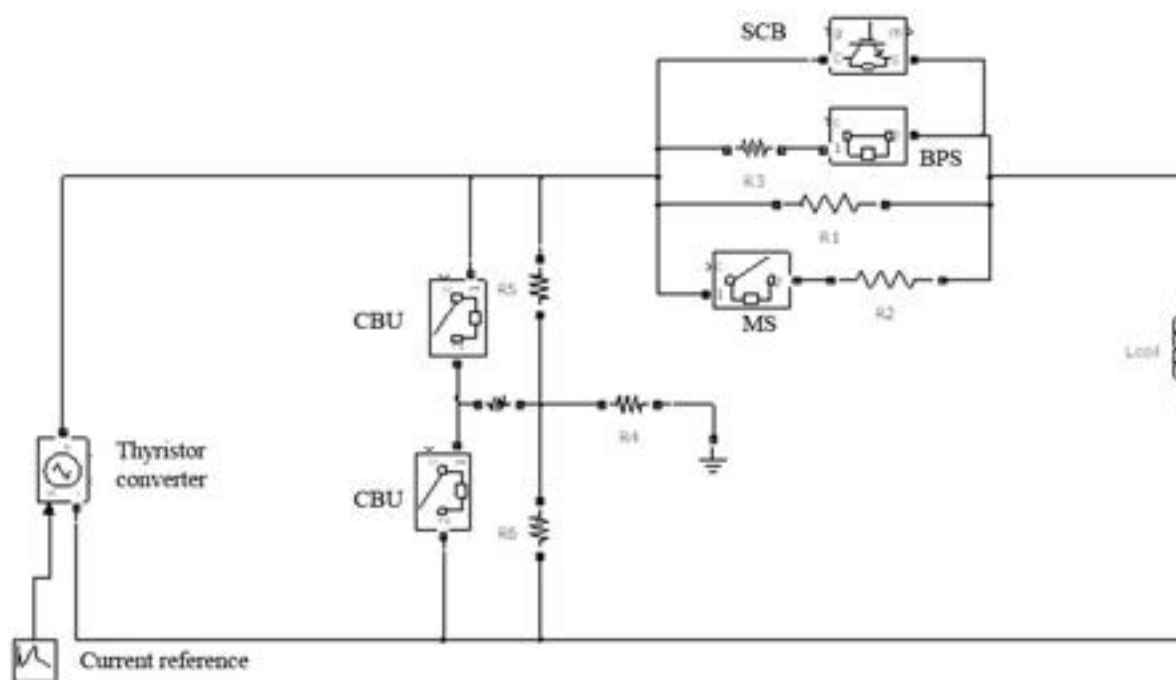



Fig. 4: Schema di riferimento ibrido proposto (schermata di un modello di simulazione).

Table 2: Main components of the SNU (see Fig. 4-1 of the technical specifications).

SNU Components	Quantity
Fast SNU switch (SS)	1 for each SNU
Making switch (MS)	1 for each SNU
Breakdown resistors (R1 and R2) with associated selectors	2 sets for each SNU
Grounding switches (GSs)	2 for each SNU
SNU control, protection and measurement system	1 single system for all the 4 SNUs
Cooling and compressed-air (if required) systems, enclosures, internal connections	As many as necessary

 Italian National Agency for New Technologies, Energy and Sustainable Economic Development	 UTFUS Fusion EURATOM-ENEA Association	Report Ricerca di Sistema Elettrico Accordo di Programma Ministero dello Sviluppo Economico: Specifiche tecniche per la realizzazione degli switching network unit dei solenoidi centrali del tokamak JT-60SA	ENEA ID: RT-JT60-SA-007	Page: 15/37
			Autore: Alessandro Lampasi	Rev. 0 Nov 2011

4 Lo schema di riferimento ibrido

Le operazioni precedentemente descritte non sono affatto banali con i dispositivi elettrici normalmente utilizzati. In particolare, occorre tener presente che la sincronizzazione degli eventi è indispensabile per la creazione del plasma e che questa è richiesta con un'accuratezza e ripetibilità inferiori a 1 ms.

Per questi motivi, l'unica soluzione pratica percorribile è quella di realizzare l'interruttore SS con un approccio "ibrido", cioè sfruttando il parallelo di più dispositivi, in parte elettromeccanici in parte statici.

L'accuratezza temporale può essere ottenuta solo utilizzando uno static circuit breaker (SCB) in grado sia di aprire sia di chiudere il circuito sotto carico. Esso deve essere composto da almeno 6 IGCT in parallelo (in base alla ridondanza desiderata). Rimane ancora aperta la questione se occorre utilizzare 2 IGCT in serie per ogni ramo parallelo (questo dovranno garantirlo i costruttori dei componenti anche tenendo conto dei risultati dei primi test). È importante rilevare che sia la serie che il parallelo degli IGCT sono critici e necessitano di un'attenta selezione dei componenti nonché una rete di componenti aggiuntivi (snubber, diodi di protezione, ecc.).

Poiché i componenti dell'interruttore SCB non potrebbe mai supportare (specialmente per motivi termici, ma anche perché è unidirezionale) tutto lo scenario di corrente, è necessario inserire un by-pass switch (BPS) elettromeccanico dimensionato per un funzionamento di ± 20 kA (più un margine di ± 3 kA in caso di disruzione del plasma) per 250 s.

L'interruttore BPS potrebbe interrompere la corrente anche da solo, ma lo farebbe con una grande incertezza rispetto ai tempi e producendo un arco elettrico ad ogni operazione che richiederebbe interventi di manutenzione frequenti (si tenga presente che lo SNU interviene normalmente in ogni esperimento sul plasma). Per questo, la parte SCB deve sostenere una chiusura e riapertura per ogni operazione sia di apertura che di chiusura dell'interruttore BPS. I tempi e la sincronizzazione di questi automatismi devono essere attentamente studiati e regolati, inviando il comando in anticipo quando necessario.

Il controllo generale delle operazioni è affidato ad un controllore locale (LCC) connesso al resto del sistema da una rete deterministica basata su reflective memory (RM). Sono anche previsti segnali di emergenza con connessioni dedicate. Per garantire un'efficiente diagnostica delle operazioni sono richieste misure di corrente in ogni ramo con una banda di almeno 5 kHz.

5 Introduzione alle specifiche tecniche degli switching network unit

Le prossime sezioni del rapporto presentano (in lingua originale inglese) le specifiche tecniche dettagliate che saranno utilizzate dall'ENEA per la realizzazione dei 4 SNU dei CS del tokamak JT-60SA (e, con le modalità descritte, per gli EF).



Come previsto dagli accordi internazionali (AoC e PA), le specifiche sono state discusse con i partner europei e giapponesi ed ufficialmente approvate da F4E. In particolare, la versione corrente delle specifiche è stata rilasciata il 27 luglio 2011 (ENEA ID: SPT-JT60SNU-01; JT-60SA DMS: BA_D_226442) ed è l'evoluzione delle precedenti stesure (ENEA ID: ING A JT0030/R; vecchio JT-60SA DMS UID: AST_D_224GNK; nuovo JT-60SA DMS UID: BA_D_224GNK).

Sono stati esclusi dalla seguente esposizione i dettagli commerciali, le informazioni derivate da documenti interni del progetto JT-60SA ed alcuni riferimenti incrociati presenti nelle specifiche ufficiali.

6 Scope of the Procurement

The technical specifications of this Call for Tender regard the design, manufacturing, factory testing, packaging, transportation to the Port of Entry in Japan (PoE) [ANX6], installation on site, commissioning and final testing of the 4 SNU of the CSs of the new JT-60SA tokamak. These 4 coils are classified as CS1, CS2, CS3 and CS4.

The SNU main components included in the present Procurement are listed in Table 2.

 <i>Italian National Agency for New Technologies, Energy and Sustainable Economic Development</i>	 UTFUS <i>Fusion EURATOM-ENEA Association</i>	Report Ricerca di Sistema Elettrico Accordo di Programma Ministero dello Sviluppo Economico: Specifiche tecniche per la realizzazione degli switching network unit dei solenoidi centrali del tokamak JT-60SA	ENEA ID: RT-JT60-SA-007	Page: 16/37
			Autore: Alessandro Lampasi	Rev. 0 Nov 2011

In addition to the main components of Table 2, the Supply shall also include the following items:

- The draft and the detailed design of the components object of the Supply (see Section 8.3 of the technical specifications).
- The manufacturing of the components.
- A basic set of spare parts (see Section 4.10.8 of the technical specifications).
- The tests at the IS's facilities (following the requirements described in Section 5.2 and 5.3 of the technical specifications).
- The packaging of the Supply (see Section 6 of the technical specifications).
- The delivery of all the components to the PoE in Japan (see Section 6 of the technical specifications). JAEA will be responsible for transportation from the PoE to Naka Site, including formalities and temporary storage.
- The assembly, installation and commissioning of all the components at Naka Site (see Section 4.5 of the technical specifications). The installation is an option: if this option is not activated by the Customer, the Supplier shall provide a self-consistent documentation containing any information necessary to complete the installation in good conditions and respecting the time schedule.
- The Site Acceptance Tests at Naka Site (following the requirements described in Section 5.4 and Section 5.5 of the technical specifications).
- Any set of special handling gears and appliances that may be necessary to handle the equipment safely and conveniently during its receipt and assembly on Site (these items shall remain property of JAEA).
- Any special tool and equipment necessary for the operation and maintenance of the equipment included in the Supply (these items shall remain property of JAEA).
- The documentation as described in Section 8 of the technical specifications.
- Any set of testing tools and instruments needed to commission and test the system (these items shall remain property of the IS).
- The training of the operating staff (see Section 9 of the technical specifications).

Everything that is not unequivocally included in the technical specifications is excluded. In particular, the SNU interfaces with several systems of the machine (coils' bus-bars, protection and control systems, cooling system, compressed air, buildings, low voltage auxiliaries power supplies, grounding grid, etc.) are not included in the Procurement (see also Section 4.7 of the technical specifications).

6.1 Warranty

All the components shall have a warranty for defects in the manufacture for a period of two years starting from the acceptance of the components. The warranty is limited to the direct costs of repair or remanufacturing of the components. Any other warranty is excluded.

Some extensions could be requested by the Customer, as described in Section 4.10.8 of the technical specifications.

7 Functional description of the JT-60SA power supply system

This section provides a short description of the JT-60SA power supply (PS) systems in order to introduce and identify the SNU functions and features. Such PS systems are widely addressed in the Section 2.7 of the PID [ANX1].

The PID might be updated during the Contract period. The Customer shall inform the IS about PID changes relevant for this Procurement and an agreement between the Customer and the IS shall be taken on how to cope with these changes.

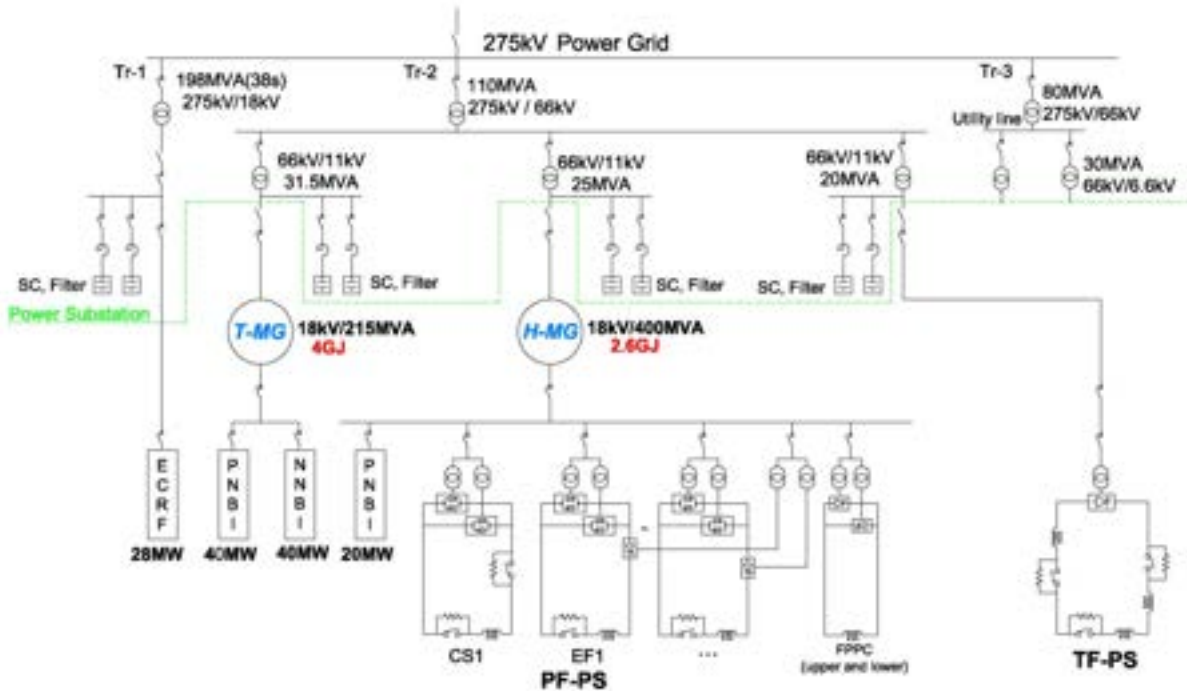

Fig. 5: Schematic diagram of the AC PS for JT-60SA [ANX1].

7.1 Overall description of the power supply system

The JT-60SA PS system mainly consists of:

1. The PSs for the superconducting coils;
2. The PSs for the Fast Plasma Position Control (FPPC) normal conductor coils;
3. The PSs for the additional heating systems, as the positive (P-NBI) and negative (N-NBI) neutral beam injectors and the Electron Cyclotron RF (ECRF) system.

As a common understanding for design of the magnet power supplies of JT-60SA, the presently available JT-60U equipment shall be reused as much as possible.

Fig. 6 shows a schematic diagram of the AC PS system for JT-60SA at Naka Fusion Institute (Japan). The figure corresponds with Fig. 2.7-1 of the PID [ANX1].

The new PS systems will be designed and manufactured to feed the superconducting toroidal field (TF) and poloidal field (PF) coils.

The ECRF system (41 MW for 100 s plasma heating) will be connected to the 275 kV commercial power grid. The P-NBI (60 MW power demand), N-NBI (40 MW power demand) and PF coil PSs will be connected to two existing motor generators (215 MVA / 4.0 GJ, 400 MVA / 2.6 GJ).

7.1.1 Overview of the poloidal field (PF) coil power supply

The PF coil PS shall provide a bipolar DC current adequate to achieve the required scenarios. The existing JT-60 TF transformers will be re-used for 8 of the CS and equilibrium field (EF) PSs as they result compatible with the scenarios.

The basic circuit components are a Base PS, a Booster PS and a SNU.

It is planned to re-use the existing vertical field coil PS (PSV) as a Booster PS.

The SNU is added into each CS PS and into the EF3 and EF4 PS to produce the high voltage necessary for the plasma breakdown and plasma current ramp-up. In principle, the SNU consists of DC current interrupters and tunable resistors, as described in the following.

As shown in the schemes, the Base PS includes the power transformers, the thyristor converters and the crow-bar switch.

Table 3: Specifications for Base/Booster PSs and SNUs for CS1-4 and EF1-6 [ANX1].

	BASE PS (1)(2)(3)(8) (duty cycle: 250s/1800s)				BOOSTER PS(5) (short time rating)						SNU (kV) Repetition time 1800s (7) (9)	
					Forward			Reverse				
	XFMR $U_{10\text{rms}}=18\text{kV}$		V_{dc0} (kV)	I_{dc} (kA)	XFMR $U_{10\text{rms}}=18\text{kV}$		V_{dc0} (kV)	I_{dc} (kA)	XFMR $U_{10\text{rms}}=18\text{kV}$			V_{dc0} (kV)
	$U_{20\text{rms}}$ (kV)	Z% (4)		$U_{20\text{rms}}$ (kV)	Z% (4)			$U_{20\text{rms}}$ (kV)	Z% (4)			
CS1	0.8 ⁽⁶⁾	23	1.0	$\pm 2*10$								-5.0
CS2	0.96	24	1.25	$\pm 2*10$								-5.0
CS3	0.96	24	1.25	$\pm 2*10$								-5.0
CS4	0.8 ⁽⁶⁾	23	1.0	$\pm 2*10$								-5.0
EF1	0.8 ⁽⁶⁾	23	1.0	$\pm 1*10$	2.9				3.16			
	0.8 ⁽⁶⁾	23	1.0	$-1*10$	+ 2.9	24	7.8	+4	+ 2.1	24	7.1	-14.5
EF2	0.72 ⁽⁶⁾	18	0.97	$\pm 2*5$	2.9				3.16			
	0.72 ⁽⁶⁾	18	0.97	$-2*5$	+ 2.9	24	7.8	+4	+ 2.1	24	7.1	-14.5
EF3	0.72 ⁽⁶⁾	18	0.97	$\pm 4*5$								-5.0
EF4	0.72 ⁽⁶⁾	18	0.97	$\pm 4*5$								-5.0
EF5	0.72 ⁽⁶⁾	18	0.97	$\pm 2*5$	2.9				3.16			
	0.72 ⁽⁶⁾	18	0.97	$-2*5$	+ 2.9	24	7.8	+4	+ 2.1	24	7.1	-14.5
EF6	0.8 ⁽⁶⁾	23	1.0	$\pm 1*10$	2.9				3.16			
	0.8 ⁽⁶⁾	23	1.0	$-1*10$	+ 2.9	24	7.8	+4	+ 2.1	24	7.1	-14.5

NOTE :

(1) Back-to-back four quadrants (with circulation current), 12 pulses (6 pulses during circulation current operation), demineralised water cooled converters including crow-bar unit. For each 12-pulses converter the following demi-water cooling main characteristics are needed (to be confirmed):

- $Q = 24 \text{ m}^3/\text{h}$
- $T_{\text{in}} \leq 35 \text{ }^\circ\text{C}$
- $\Delta T_{\text{in,out}} = 10 \text{ }^\circ\text{C}$
- $P_{\text{in}} = 450 \text{ kPa}$
- $\Delta P_{\text{in,out}} = 250 \text{ kPa}$
- $\rho \geq 1 \text{ M}\Omega\cdot\text{cm}$

(2) Insulating voltage to ground : $U_{\text{M}} = 9 \text{ kV}$ (ref. IEC 146-1-1 sections 4.2.1.3 and 4.2.1.4, where factory test voltage is defined as $V_{\text{test}} = 4 + 1.8U_{\text{M}}/1.41$ and U_{M} is defined as " highest crest voltage".)

(3) DC current accuracy (%) = $\pm 1\%$ of nominal value

(4) Tentative values referred to XFMR power at secondary side, at 77.6Hz

(5) Two quadrants converters

(6) Already existing XFMR

(7) Reference highest voltage for equipment (IEC 60071) = 7.2 kVrms

(8) Reverse-side converters for EF1, EF2, EF5, and EF6 have two quadrants (with circulation current).

(9) For each SNU unit a cooling water flow $Q = 6 \text{ m}^3/\text{h}$ is requested. In principle raw water is acceptable, if available otherwise demineralised water should be provided.

The specification of inter-phase reactor shall be defined to be compatible to the thyristor converter and transformers.

The current reversing links (CRLs) are inserted in the CS and EF coil PSs to allow plasma operations with a reversal in the polarity of the toroidal magnetic field.

In case of a quench of a superconducting coil or of a failure in the PS, the magnetic energy stored in the coil must be rapidly extracted in order to protect the conductor and to shut down the plasma operation. For this purpose, a quench protection circuit (QPC) consisting of a DC current interrupter, a dump resistor and a Pyrobreaker for back-up protection has to be provided for each superconducting coil. The SNU (and the Booster) shall be by-passed in case of operation of the related QPC to avoid overvoltages on the coil [ANX1]. The QPC is not included in this Procurement.

Table 3 shows the basic specifications of the Base PSs, Booster PSs and SNUs for the CS 1-4 and EF 1-6 coil PSs, as reported in Table 2.7-6 of the PID [ANX1].

7.1.2 Role of the SNU in a current scenario

Generally, the current scenarios of a tokamak have a first phase where the current ramps up (supplied by the Base PS) until a maximum value. Once this maximum value is reached, a sudden decrease of the current is triggered by inserting a resistor or a Booster PS in order to produce the plasma current breakdown. In the JT-60SA CS1-4 and EF3-4, the sharp current variation required at the breakdown shall be realized by SNUs.

The SNU is purposely designed to insert a suitable resistor in series with the coil circuits, just immediately before the plasma breakdown. The sharp change in the coil current derivative induces a voltage in the plasma that triggers its ramp-up.

After the plasma start, there is a second phase of the scenario in which the SNU resistance generally needs to be changed in order to follow the scenario current reference.

When the plasma current exceeds a prefixed value, the SNU short-circuits the resistor(s) to exclude it from the power circuit.

7.1.3 Other coil power supplies

The EF coil PSs are basically based on the same principles presented for the CS PSs.

The circuit for the TF coil PS is shown in Fig. 7, corresponding with Fig. 2.7-2 of the PID [ANX1]. The 11 kV network provides the AC source voltage of the TF coil PS.

The TF coil PS shall be able to provide the required 25.7 kA DC current continuously to the superconducting TF coils. The nominal DC voltage shall be sufficient to charge or discharge the full current within about 20 minutes. Typical operation of the TF coil PS is that the TF coils are energized every day in the morning before the starting of the plasma experiments and demagnetized after the experimental period.

The set of the JT-60SA PSs is completed by the PSs for upper/lower FPFC coils, for Resistive Wall Mode (RWM) suppression and for error field correction.

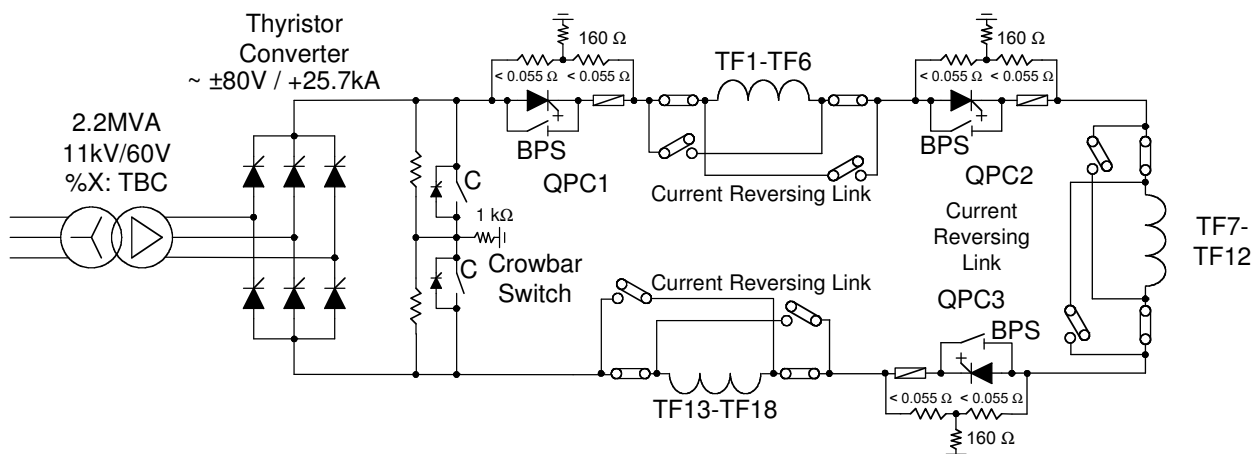



Fig. 6: Schematic of the TF coil circuit configuration [ANX1].

 <i>Italian National Agency for New Technologies, Energy and Sustainable Economic Development</i>	 UTFUS <i>Fusion EURATOM-ENEA Association</i>	Report Ricerca di Sistema Elettrico Accordo di Programma Ministero dello Sviluppo Economico: Specifiche tecniche per la realizzazione degli switching network unit dei solenoidi centrali del tokamak JT-60SA	ENEA ID: RT-JT60-SA-007	Page: 20/37
			Autore: Alessandro Lampasi	Rev. 0 Nov 2011

8 SNU specifications and requirements

The IS must develop his technical proposal in accordance with the functional specifications included in the present document.

A reference solution has been used for numerical simulations and verifications both for the single SNU and for the global coil PS circuit.

The final solution proposed by the IS shall be agreed with the Customer during the Detailed Design Phase (DDP). In any case, the IS shall take upon himself the comprehensive liability on the conformity of the technical proposal to the specifications and to the other documents and references related to the Procurement.

8.1 SNU basic scope

The SNU functional scheme is displayed in Fig. 2.7-11 of the PID [ANX1]. The SS has to close and open while the load current is flowing, in order to insert the resistance R1 in the coil circuit. The MS has to insert, during the shot, the resistance R2 that will be in parallel with R1.

The values of the resistance R1 and R2 change according to the resistors pre-inserted in the circuit. The values of the two sets of resistors R1 and R2 are arranged, before the start of the pulse, by the selectors C2, C11, C12, C13 and C14.

Since the voltage drops caused by R1 and R2 are directly proportional to the current amplitudes, different scenarios can be realized by modifying the resistances values. During a single shot it is possible to insert a resistance value for each resistor set R1 and R2, pre-arranged by an opportune combination of the values.

A typical current diagram in a tokamak coil is shown with the only purpose to clarify the SNU operational sequence. This sequence is summarized in the following:

1. In the ramp-up phase the Base PS, based on thyristor converters, increases the coil current up to a maximum positive value (20 kA). In this phase, the SS is closed and the MS is opened.
2. At the breakdown, the SS switches off. Consequently, the current changes over the resistor set R1 and its derivative changes immediately.
3. After some tens of milliseconds, if a smaller current derivative is needed, the MS inserts the resistor set R2 in the coil circuit. The timing accuracies of the SS and MS are particularly critical because strictly related to the plasma start-up.
4. After this phase, and in any case before the possible current reversal, the resistors will be disconnected from the power circuit closing again the SS (the MS can be opened at zero current flowing in its branch).
5. The state of the SNU does not change during the rest of the scenario. The entire scenario can last up to 250 s.

The switching commands for the SS and the MS come from the JT-60SA control systems. As their timing depends on the current scenario around the breakdown, the SNU Local Control Cubicle (LCC) shall check, also, the right sequence (interlocks) of the switching commands (SS opening → MS closing → SS closing).

The SS shall be sized for the nominal current (20 kA) and for the maximum pulse length (250 s). The data fixes also the characteristics of the switches related to the resistors. In particular, since the resistance R2 is inserted by the MS, the MS shall be sized considering the dump energies of the resistors R21 and R22.

The maximum operational voltage and the reference highest voltage for equipment (IEC 60071 [STD1]) are identical for all the resistors and correspond to the maximum values possible in the SNU.

The specifications of the SNU components and systems and their operation mode are described in the following sections.

Table 4: Main parameters of the SNU.

SNU Parameter	Value
Nominal current	±20 kA
Maximum current	±23 kA
Maximum pulse length	250 s
Minimum repetition time	1800 s
Current interruption	Unidirectional
Maximum voltage between terminals	5 kV
Reference highest voltage for equipment (IEC 60071)	7.2 kV rms
SS and MS maximum switch-on/off time	≤1 ms
SS operation accuracy/repeatability	≤0.5 ms
MS operation accuracy/repeatability	≤1 ms
SNUs installation	Indoor
Indoor maximum to minimum temperature	40/5 °C
Maximum monthly average relative humidity	87%
Accuracy of each breakdown resistor (at 20°C)	±2%
Maximum variation of resistors with temperature	±10%
Number of operations without maintenance (excluding sacrificial contacts)	10000

8.2 SNU functional parameters and operating mode

Table 4 summarizes the main parameters on which the SNU design shall be based, as explained in the following.

The nominal current reported in the table refers to the expected standard operational conditions. In addition, it is necessary to consider that a plasma disruption can induce in the coil current a step increasing of 2.6 kA (see also Section 4.9.1 of the technical specifications).

The repetition time is the time interval between two following experimental pulses (see Table 1.2-1 of the PID [ANX1]). A pulse can last a maximum of 250 s including a maximum initial ramp-up time of 40 s. The JT-60SA working time for the experiments shall be 10 hours per day.



The operations shall be performed except in the case of dew condensation. JAEA will stop the operations in case of risk of dew condensation.

The scenarios included in the PID [ANX1] could be changed during the project. In case of changes, the possible consequent modifications in the SNUs shall be agreed between the Customer and the IS.

All the PF coil PSs are 4-quadrants type, so both the voltage and the current can reverse. As the SNUs operate in a fixed phase of the scenario (see Section 3.1.2 and Section 4.1 of the technical specifications) in which the current direction does not change, the current can be considered unidirectional to the SNU aim. If the inversion of the coil currents is needed, it could be realized by the CRL polarity changers. In any case, the SS shall be re-closed before the reversing of the load current.

The maximum voltage between the SNU terminals is 5 kV (this value may be reached at the breakdown). As a consequence, in compliance with the Standard IEC 60071 [STD1], the insulation level of the device should be 7.2 kV rms. In fact, according to the Table 2 in Standard IEC 60071-2 [STD1], the corresponding standard rated short-duration withstand voltage is 20 kV rms.

The SS operation controls the plasma start-up, so it must be very fast and accurate. In particular, the SS has to switch-off (namely, its current decreases under the 2% of its initial value) in less than 1 ms after the activation of the related command and the accuracy of the timing of the operation must be better or equal to 500 μs (see Section 5.2.2 of the technical specifications). Therefore, in the worst-case the SS switch-off time can be 1.5 ms. The same requirements will be assumed for the SS turn on.

 Italian National Agency for New Technologies, Energy and Sustainable Economic Development	 UTFUS Fusion EURATOM-ENEA Association	Report Ricerca di Sistema Elettrico Accordo di Programma Ministero dello Sviluppo Economico: Specifiche tecniche per la realizzazione degli switching network unit dei solenoidi centrali del tokamak JT-60SA	ENEA ID: RT-JT60-SA-007	Page: 22/37
			Autore: Alessandro Lampasi	Rev. 0 Nov 2011

If the SS turn on and off commands consist in a sequence of commands, the value for the “Maximum switch on/off time” refers to the final command that inserts or removes the resistors in/from the coil circuit.

The MS switch-on time can be identical to the SS one (1 ms), while the accuracy can be up to 1 ms (worst-case switch-on time 2 ms).

8.3 Control strategy

The JT-60SA Supervisory Control System and Data Acquisition System (SCSDAS) is described in Section 2.17 of the PID [ANX1]. The JT-60SA control system will also include a system for handling the protection signals received from the equipment and distribute the protection commands (GPS) and a system for managing the safety interlock signals (SIS). The detailed design of such systems is yet under development.

The JT-60SA PS system will be directly managed by a dedicated Power Supply Supervising Computer (PS SC), provided by JAEA, that communicates with SCSDAS, GPS and SIS. The PS SC includes an Internal Protection System (IPS) that coordinates protective actions among all JT-60SA PS components and among them and the remaining parts of the JT-60SA system.

The SNU Procurement includes a dedicated LCC with functions of control, backup, protection, interface and information. The LCC hardware essentially consists of a central unit based on PLC or industrial PC devices and of a set of interfaces towards the SNUs and the human-machine interface (HMI). The HMI hardware shall contain an LCD screen with touch commands or keyboard to display and control friendly high-level panels, possibly including graphic mimics of the devices.

Each SNU can operate either in local control mode (LCM) or in remote control mode (RCM), depending on the state of a key selector placed on each SNU. The HMI monitors the plant status and measurements in both modes. The safety signals are independent of the selected mode. Each SNU shall have a panel signaling the LCM/RCM and on/off operations, just as the interlock devices (alarm push button, safety interlocks).

In the LCM case, the HMI provides an easy management of all the input/output actions (commands, sequences, status monitoring, measurements, and so on) necessary for effective SNU commissioning, testing and troubleshooting. Also in LCM, the LCC transmits the signals from the SNU to the PS SC.

When the RCM is activated, the SNU will be under the control of the PS SC. In this case, the switching commands will come directly from the PS SC and the LCC will transfer them, after checking all the necessary conditions, to the implementing device with the time constraints summarized in Table 5.

In general, the signals can be classified according to the type of connection as:

1. Signals transmitted through the Reflective Memory (RM);
2. Signals transmitted through optical links (single signals or encoded signals);
3. Hardwired protection commands;
4. Ethernet-based links for process control and trouble-shooting.

Moreover, from the point of view of their updating rate, the signals can be classified as:

1. Slow signals, intended for system configuration, monitoring (including status and alarm visualization), slow measurements and safety interlock signals (typically managed by the SIS);
2. Fast signals, intended for purposes of timing, data acquisition and real time control (typically managed by the GPS).



The IS shall provide the RM units, produced by General Electric (see [REF3]), for the communications (alarms, states, commands and measurements) with the control systems. The architecture of the RM loops for the power supply control system is sketched in Fig. 1 of [REF3]. The IS shall also provide Ethernet access to its CPUs/controllers by using only standard ways of communications and software interfaces.

The IS has to evaluate if the management of the fast signals and of the sequence need a specific hardware (e.g. FPGA), while the slow signals can be usually handled by PLCs or industrial PCs.

Table 5 reports a tentative list of the signals between each SNU, the LCC and the control systems. A more detailed list of the status, command, alarm, measurement signals to be exchanged in JT-60SA is provided in [REF2]. The final list with the related features shall be fixed during the DDP.

Table 5: List of signals transferred to/from LCC from/to PS SC.

	Description	Accuracy / Values	Band / Rate	Path (from/through/to)
Measurements	Voltage at the SNU terminals	±1%	Analog band ≥3 kHz	Each SNU → LCC → PS SC
	Total current	±1%	Sampling frequency ≥4 kHz	Each SNU → LCC → PS SC
	SS current (CT in Fig. 4-1)	±1%	Sampling frequency ≥4 kHz	Each SNU → LCC → PS SC
	R1 current (CT in Fig. 4-1)	±1%	Sampling frequency ≥4 kHz	Each SNU → LCC → PS SC
	R2 current (CT in Fig. 4-1)	±1%	Sampling frequency ≥4 kHz	Each SNU → LCC → PS SC
	Resistor temperature	±2.5%	Analog band ≥10 Hz	From each SNU resistor (6 per SNU)
	Cooling/water temperature	±2.5%	Analog band ≥10 Hz	Each SNU → LCC → PS SC
	Spare	±1%	Analog band ≥3 kHz	LCC
	Spare	±2.5%	Analog band ≥10 Hz	LCC
Status and Alarm Signals	SNU LCM/RCM	On/Off	Slow	Each SNU → LCC → PS SC
	Input GS closed	On/Off	Slow	Each SNU → LCC → PS SC
	Output GS closed	On/Off	Slow	Each SNU → LCC → PS SC
	Resistor(s) pre-arrangement	Encoded	Slow	Each SNU → LCC → PS SC
	SS close/open	On/Off	Fast	Each SNU → LCC → PS SC
	MS close/open	On/Off	Fast	Each SNU → LCC → PS SC
	SNU ready	On/Off	Slow	Each SNU → LCC → PS SC
	SNU fault	On/Off	Fast	Each SNU → LCC → PS SC
	SNU fault description	Encoded	Slow	Each SNU → LCC → PS SC
	Upload log file	Encoded	Slow	LCC → PS SC
	Emergency (Stop)	On/Off	Fast	Each SNU → PS SC
	Spare	On/Off	Slow	Each SNU → LCC → PS SC
	Spare	On/Off	Fast	LCC → PS SC
	Commands	SNU on (auxiliaries on, initial arrangement, etc.)	On/Off	Slow
SNU off		On/Off	Slow	PS SC → LCC → Each SNU
Selector C2 close/open		On/Off	Slow	PS SC → LCC → Each SNU
Selector C11 close/open		On/Off	Slow	PS SC → LCC → Each SNU
Selector C12 close/open		On/Off	Slow	PS SC → LCC → Each SNU
Selector C13 close/open		On/Off	Slow	PS SC → LCC → Each SNU
Selector C14 close/open		On/Off	Slow	PS SC → LCC → Each SNU
SS open		On/Off	Fast	PS SC → LCC → Each SNU
SS close		On/Off	Fast	PS SC → LCC → Each SNU
MS open		On/Off	Slow	PS SC → LCC → Each SNU
MS close		On/Off	Fast	PS SC → LCC → Each SNU
SNU local mode		On/Off	Slow	PS SC → LCC → Each SNU
Spare		On/Off	Fast	PS SC → LCC → Each SNU
Spare		On/Off	Slow	PS SC → LCC

 Italian National Agency for New Technologies, Energy and Sustainable Economic Development	 UTFUS Fusion EURATOM-ENEA Association	Report Ricerca di Sistema Elettrico Accordo di Programma Ministero dello Sviluppo Economico: Specifiche tecniche per la realizzazione degli switching network unit dei solenoidi centrali del tokamak JT-60SA	ENEA ID: RT-JT60-SA-007	Page: 24/37
			Autore: Alessandro Lampasi	Rev. 0 Nov 2011

The IS shall provide all the measurements (voltage, current, temperature, water/air flow, etc.) necessary to control and protect the system, including proper adjustable thresholds. The signals defined as “spare” in Table 5 will be defined in the DDP or will be available for later modifications/integrations.

The measurement accuracy required in Table 5 must be evaluated considering the total measuring chain from the probe to the interface with the PS SC. The percentage is referred to the measurement full scale. The analog measurement band is the signal maximum useful frequency, corresponding to the cut-off frequency at -3 dB.

All the alarms from/to the SNU, the LCC and the PS SC will be of fail-safe type. This means that the absence of the signal (light, voltage, current) must be considered as an alarm’s presence.

The LCC shall elaborate, display and save a log file in which all the changes in the SNU’s conditions and states are recorded with the corresponding time.

Both in LCM and in RCM, the LCC shall be able to pre-arrange the resistor sets by the C2, C11, C12, C13, C14 selectors according to the desired pulse characteristics.

In every condition, the LCC has to check the right working of the SNU components and systems and carry out all the procedures, of fail-safe type, to protect them. They shall be defined in the DDP according to proposals made by the IS [ANX5].

The subject of the human safety regarding the activities on the SNU’s shall be carefully analyzed by the IS. The human safety must rely on fail-safe and hardware components (mechanical interlocks, grounding connections and switches, circuit breakers, screens, etc.). During the DDP, all the information necessary to design the system in compliance with the safety rules will be given. Detailed information on the JT-60SA safety rules can be found in [ANX2].

8.4 SNU cooling system

The SNU’s will be cooled by the cooling water plants of Naka Site. The inner cooling plants of the SNU are included in this Procurement. The SNU IS should terminate the internal cooling plants with proper flanges. The connections from these flanges to the Naka Site cooling water plants are not included in the Procurement. The mechanical interfaces for such connections shall be defined during the DDP.

The SNU will be installed at the second floor of the Rectifier building (see [DWG1]). In this room, a demineralized water cooling system for aluminum components and a raw water cooling system (JT-60SA Secondary Cooling System) are available.

The available flow rate of raw water for the SNU (breakdown resistors) cooling is 6 m³/h (see Table 2.7-6 of the PID [ANX1] and the water cooling diagram in Fig. 2.7-12 of the PID [ANX1]).

SNU losses cannot be directly dissipated into the installation room, so the heat losses must be transferred to the raw water.



The IS shall assess if the demineralized water cooling is necessary for the SNU static switches (mainly considering the results of his fault analysis). This option shall be agreed with the Customer during the DDP.

The sizing, layout and cooling of every power component should be analyzed in order to fulfill, with adequate safety factors, its temperature limits. The IS, considering also the dump energies and resistors specifications, shall design the cooling system to ensure that the temperatures of the SNU components go back to the initial values within 30 minutes.

The available measurement systems shall monitor the hottest points of the SNU, identified during the DDP and modified, if needed, after the testing phase. The temperature measures coming from the SNU should be collected and elaborated by the LCC that controls the cooling system and provides summarized information to the PS SC.

The water circulation in the SNU shall be checked by flow switches. Insulating valves shall be installed at the interface points with the Site plant and anywhere needed to facilitate the maintenance procedures. Furthermore, proper automatic air bleed valves, filters and drain valves shall be fitted up.

Section 10 of the technical specifications presents some details of the available cooling systems and provides other relevant information (ambient conditions, air ventilation, site facilities, and so on).

 Italian National Agency for New Technologies, Energy and Sustainable Economic Development	 UTFUS Fusion EURATOM-ENEA Association	Report Ricerca di Sistema Elettrico Accordo di Programma Ministero dello Sviluppo Economico: Specifiche tecniche per la realizzazione degli switching network unit dei solenoidi centrali del tokamak JT-60SA	ENEA ID: RT-JT60-SA-007	Page: 25/37
			Autore: Alessandro Lampasi	Rev. 0 Nov 2011

8.5 Layout and installation requirements

The IS shall be responsible for the assembly and installation on Site. The IS shall submit an installation plan as described in Section 8.3.3 of the technical specifications.

Before the start of the installation phase, JAEA will make available all the areas where the SNUs will be installed. Moreover, JAEA will make available for the ISs the services described in [ANX2] and [ANX3].

During the assembly and installation activities, the IS shall apply and follow all the requirements and rules reported in [ANX2] and [ANX4].

If needed, additional layout drawings of the relevant JT-60SA buildings will be provided by the Customer during the DDP. Possible revisions necessary during the development of the design will be agreed as applicable.

The design of the SNU system shall be compatible with the JT-60SA layout and with the provided information.

The SNU shall be installed where indicated in the drawing [DWG1]. The SNU size shall be consistent with the available dedicated area and access gates showed in the drawings [DWG1] and [DWG2]. The four SNU shall be installed in the Rectifier Room of the Rectifier Building as shown in the drawing [DWG1]. This drawing includes the areas available for the SNU (diagonal broken lines) and some possible space allocations (rectangles SS, MS, R, S1). The space allocations suggested by the rectangles SS, MS, R, S1 are only indicative.

The average load to the floor shall be less than 700 kg/m² for Rectifier Room (see [DWG3]). This value will be confirmed during the DDP. The basement geometry of the devices shall be agreed with the Customer during the DDP.

No crane is available in the areas where the SNU will be installed.

An overall description of the JT-60SA Site and buildings is reported in Section 2.22 of the PID [ANX1].

8.6 Enclosures

All the live parts of the SNU shall be housed in cubicles and cabinets to avoid the access to hazardous parts.

The enclosures must comply with the Standard IEC 60529 [STD6]. The protection degree of the cabinets containing the switches and the resistors must be at least IP 52DH. The IP codes could be reviewed and agreed with the Customer during the DDP.

The signals terminal blocks and the command/control boards should be separated, by a protection shield, from the hazardous parts.

The SNU internal circuits shall be protected by proper main circuit breakers. Additional circuit breakers must be inserted to separate and effectively protect different subsets of equipment according to their location or functionality. Each circuit breaker shall interrupt all the AC phases and the neutral or both the DC polarities ($\pm V_{DC}$).

A 200 V AC mains plug shall be fitted inside each cabinet and shall be protected by a differential circuit breaker (16 A, 300 mA). All the circuit breakers shall be in accordance with the IEC standards.

A holder for documents shall be fitted outside one of the cabinet doors.



The cubicles shall be fitted with low-consumption lamps for internal lighting, turned on by the opening of the doors.

Dimensions of any panel, box and cabinet shall contain a minimum of 20% of spare area (for panels) or volume (for boxes and cabinets). The wiring channels shall contain a minimum of 20% of spare space.

The wiring channels shall be halogen-free and flame retardant (see Section 4.10.4 of the technical specifications), fitted with a cover and secured by screws.

The doors shall be provided with locks. In any case, the internal parts of the SNU will be accessible only in compliance with the safety procedures described in Section 4.9.6 of the technical specifications.

The thickness of the steel of the cabinets will be at least 1.5 mm. The plates will be passivated and painted by epoxy polyester powder coating. The color code will be given in the DDP.

 <i>Italian National Agency for New Technologies, Energy and Sustainable Economic Development</i>	 UTFUS <i>Fusion EURATOM-ENEA Association</i>	Report Ricerca di Sistema Elettrico Accordo di Programma Ministero dello Sviluppo Economico: Specifiche tecniche per la realizzazione degli switching network unit dei solenoidi centrali del tokamak JT-60SA	ENEA ID: RT-JT60-SA-007	Page: 26/37
			Autore: Alessandro Lampasi	Rev. 0 Nov 2011

The mechanical cabinets must be connected to the ground grid of the Site. All its metallic parts (frame, doors, panels, etc) will be linked to the ground bolt. The grounding circuits should be designed for a single short-circuit withstand and consistent with the Standards IEC 60204-11 [STD3] and IEC 62271-200 [STD10]. All the ground connections shall be easily spotted. JAEA will connect the ground terminal of the SNU system (see Section 4.7.5 of the technical specifications) to the closest terminal of the grounding network of the building.

Adequate test points, with easy access, shall be included in the equipment to allow quick maintenance and troubleshooting. The test points will be defined during the DDP according to a proposal from the IS.

Each cubicle must be properly cooled/heated, also taking into account the site conditions described in Section 10 of the technical specifications, to ensure that all the internal components can properly operate and that no damage occurs to them.

The IS should provide all the documents certifying the conformity of the equipments to the IEC standards and the shielding code (EM) according to the Standard IEC 61000-5-7 [STD8] of the electronic cards enclosures.

8.7 Interfaces

8.7.1 General

The JT-60SA interfaces are widely presented in the PID [ANX1]. The IS shall particularly take care of all the information concerning the integration of the SNUs in JT-60SA (see in particular Section 4 of PID [ANX1]).

Fig. 2.7-6 in the PID [ANX1] shows the interfaces of each unit of the coil PSs with respect to the rest of JT-60SA systems. In the scheme, the interfaces are represented with circles. The colors of the interfaces indicate the respective procurement. The color of the line connecting two interfaces indicates the organization providing the physical connection between the interface points.

8.7.2 Interface with the DC power and the coil

The two power terminals of each SNU will be mechanically connected to the corresponding converter and coil through DC bus-bar/cables not included in the present procurement. For this purpose, the IS shall provide aluminum connection terminals, including flexible links, with suitable cross-sections. The related final design, including final position and mechanical details, shall be agreed with the Customer during the DDP.

8.7.3 Interface with the low voltage distribution system

JAEA will provide for the four CS SNUs the auxiliary electrical supplies reported in Table 6. The IS shall verify these data with respect to his requirements.

The JAEA 400 V AC normal and emergency (Emergency Generator and UPS) networks will supply the control and auxiliary plants of the SNU system.

The Emergency Generator is activated in case of failure in the normal power network. Since the generator takes few tens of seconds to start up, the power to the loads is interrupted during this time.

The IS shall design, and agree with the Customer during the DDP, the low voltage internal distribution system to be provided.

The interface between the SNU and the JAEA AC systems consists in the connections of the supply cables to the SNU terminal blocks. The IS shall install the terminal blocks of the low voltage cables in the SNU cabinets.

JAEA will provide the low voltage distribution board including the circuit breakers and the low voltage supply cables. Moreover, JAEA will lay down the low-voltage supply cables to the SNU and will terminate them at the SNU cubicles.

Table 6: Auxiliary voltages for the four CS SNUs.

Type	Network	Emergency Generator	UPS
Nominal voltage	400 V AC	400 V AC	400 V AC
Phases and wires	3ph 4w	3ph 4w	3ph 4w
Voltage variations	±10%	±10%	±5%
Nominal frequency	50±0.1% Hz	50±5% Hz	50±0.1% Hz
Total harmonic distortion	–	–	<5%
Maximum available power	40 kVA	20 kVA	6 kVA

8.7.4 Interfaces with the fluids systems

An industrial standard compressed air plant, with the features described in Section 10.3.3 of the technical specifications, is available in the installation area. If needed, the IS shall identify the features of the compressed air facilities.

The internal distribution system of the compressed air is a task of the IS. The IS shall connect his apparatus to the JAEA compressed air distribution system, adapt it to the specific needs of the apparatus (valves, measurements, filtering, lubrication, drying, pressure value, and so on) and distribute it among all devices where necessary.

Enough compressed air shall be stored in the procured apparatus to operate a full cycle (open-close-open) of all the switches. The pressure level of the stored compressed air shall be monitored and controlled, also by including suitable status/alarm signals.

JAEA provides the pipes close to the SNU cubicle and connect the local compressed air distribution system to the SNU pipes. The interface between the SNU and the JAEA compressed air distribution system consists in the termination of the pipes in the SNU cubicles.

8.7.5 Interface with the grounding grid

Each SNU, LCC and cabinet shall have a ground bolt. JAEA will connect one of them to the nearest grounding terminal of the grid. The IS shall realize the internal grounding connections among the SNU parts with copper conductors of adequate section, able to carry the fault current without voltage rises dangerous for the human safety.

All the power ground connections for the SNU high-voltage equipment shall be sized in compliance with the IEC standards.

8.7.6 Interfaces with the building

A proposal for the SNU layout is described in Section 4.5 of the technical specifications. All the SNU components will be installed indoor, in the Rectifier Room of the Rectifier Building in Naka Site. The drawing [DWG1] shows the areas available for all the SNU equipment. No extra areas will be available for the assembling.



Water cooling, compressed air and low voltage distribution plants are available in the installation room, as described in Section 4.4, in Section 10.3.3, Section 4.7.3 of the technical specifications, respectively. The building air ventilation system is described in Section 10.3.2 of the technical specifications.

The IS shall design the SNUs taking into account the constrains on the maximum load of the Rectifier Room floor as reported in Section 4.5 of the technical specifications.

JAEA will provide to the IS's staff the services described in [ANX2] and [ANX3].

8.7.7 Interfaces with PS SC, SCSDAS, GPS and SIS

The SNU LCC will exchange slow and fast signals with the PS SC. The interfaces for such signals should be mainly based on Ethernet and RM cards.

 <i>Italian National Agency for New Technologies, Energy and Sustainable Economic Development</i>	 UTFUS <i>Fusion EURATOM-ENEA Association</i>	Report Ricerca di Sistema Elettrico Accordo di Programma Ministero dello Sviluppo Economico: Specifiche tecniche per la realizzazione degli switching network unit dei solenoidi centrali del tokamak JT-60SA	ENEA ID: RT-JT60-SA-007	Page: 28/37
			Autore: Alessandro Lampasi	Rev. 0 Nov 2011

The general architecture, the communication principles, the exchanged signals and the RM loops are described in [REF2] and [REF3].

The exact rules for the selection of the interface type shall be agreed during the DDP. In general, only the RM-based signals should be adopted for communications necessary during the experiments, while Ethernet should be used only for diagnostic purposes.

The IS shall provide the suitable terminations for the interface to the PS SC. JAEA will provide the optical fibres to connect the PS SC to the SNU LCC and will terminate them in the LCC with complementary connectors. The IS shall select the most suitable connector type on the basis of his own experience. In case of selection of not-widely available connectors, the IS shall provide also the complementary connectors.

8.8 SNU reference scheme

This section presents a reference scheme for the SNU design. Obviously, the IS is free to propose another scheme that he consider more suitable to meet the technical specifications on the basis of his own experience. The final scheme shall be agreed with the Customer during the DDP. In any case, independently from the selected scheme, the IS takes upon him the full responsibility of the procured components included in the present technical specifications.

The most relevant requirements of the SNU are the time accuracy and repeatability of the SS and MS operations. In addition, these performances should be obtained minimizing the maintenance time necessary for the re-establishment of the switch contacts.

Especially for these reasons, the proposed reference design is based on the “hybrid scheme”. This name is due to the fact that the SS is implemented by two systems in parallel: the former is based on a electromechanical by-pass switch (BPS), the latter on a static circuit breaker (SCB), implemented by Integrated Gate-Commutated Thyristors (IGCTs). The SCB must meet the requested switch-on/off times supporting the BPS in diverting the current to the resistance R1.

The resistance R3 is connected in series with the BPS to create the minimum voltage drop that ensures a full conduction in the SCB, thus reducing the opening current in the BPS. Since, of course, this resistor introduces also heat dissipation, its utility and optimal value must be evaluated by the IS.

8.8.1 Typical operation sequence of the reference scheme

The basic principles of the proposed SNU scheme are here described with the help of Fig. 8. The time and current values in the graphs are only examples for preliminary simulations and not necessarily consistent with a real case. The first row in Fig. 8 reports the coil current, practically coincident with its reference signal (current scenario). The other three sub-figures display the sequence of opening/closing actions of the three switches (when the signal is high the switch is closed and vice versa).

The operation sequence is summarized in the following:

1. Before the breakdown (magnetization phase) the current in the coil increases up to its nominal maximum (20 kA). In this phase, the BPS is closed, the SCB and the MS are opened.
2. Shortly before (hundreds of milliseconds) the breakdown, the SCB switch is closed, the current diverts from the BPS to the SCB.
3. The BPS and, successively, the SCB are opened, pushing the current in the resistor R1.
4. The MS inserts the second resistance R2. This terminates the breakdown phase.
5. The cycle goes on returning to the initial conditions: the SCB and, successively, the BPS are closed, diverting the current from the resistors
6. At the end of the SNU operations, the SCB is opened and only the BPS is connected in the circuit. It is interesting to stress that in this circuit topology the current in the MS is very low and it can be easily opened.
7. After the SNU operations, the current is controlled only by the thyristor-based converter
8. If the coil current changes direction, the negative current flows only in the BPS. Anyway, the coil current can be inverted by the CRL.

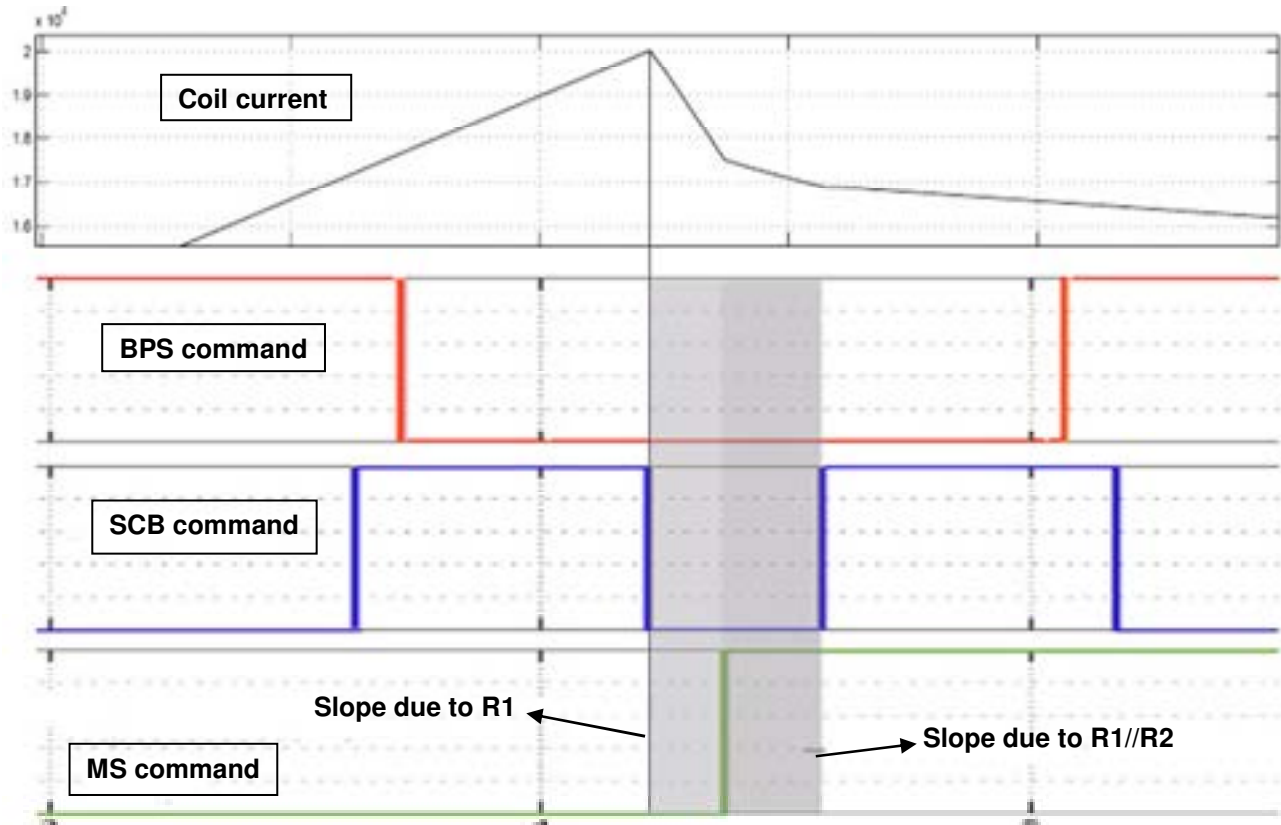

Fig. 7: Example of switching operations in the hybrid scheme. At the breakdown, the current abruptly decreases with two different slopes due to the SNU resistors R1 and R2.

8.9 Requirements on the SNU main components

8.9.1 By-pass switch (BPS)

The BPS, as proposed in the hybrid scheme, is an electromechanical device that conducts the coil current before and after the breakdown phase. Therefore, the BPS shall be designed to sustain the nominal current for the whole pulse length.

The main parameters concerning the BPS are summarized in Table 7. The IS design shall include a description of the main characteristics of the selected device in order to verify their agreement with the technical specifications.

The value of maximum current I_{BPSmax} takes into account that the plasma disruption can induce in the coil circuit a current step increase of maximum 2.6 kA for some milliseconds.

The maximum interrupting capability requested to the BPS depends on the selected operational scheme and could be reduced by the insertion of the resistance R3.

If the BPS is implemented by more parallel contacts, the current among them must be as uniform as possible. To this aim, the current unbalance factor for a parallel contact is defined in the technical specifications $\Delta I_{contact}$. Then, the maximum $\Delta I_{contact}$ allowed in the contacts should be under the 20%. Such value will be verified in Factory Tests.

The BPS component selection shall be focused on the maintenance requirements: the BPS shall ensure at least 10000 mechanical open/close operations without maintenance (excluding the sacrificial contacts). The IS shall indicate the nominal number of open/close operations at nominal current before maintenance, in particular for the sacrificial contacts. This number is expected to be not less than 300.

If the switch is operated by compressed air, it shall complete at least two open/close/open cycles when disconnected from the JAEA compressed air system.

Table 7: Basic technical data of the BPS (see also Table 4).

BPS Parameter	Value
Nominal current	±20 kA DC
Maximum current I_{BPSmax}	±23 kA DC
Maximum pulse length	250 s
Minimum repetition time	1800 s
Current direction	Bidirectional
Maximum voltage between terminals	5 kV
Highest voltage for equipment (IEC 60071)	7.2 kV rms
Opening time	≤10 ms
Operation accuracy/repeatability	≤5 ms
Number of operations without maintenance (excluding sacrificial contacts)	10000
Open/close/open cycles without compressed air	≥2

Table 8: Basic technical data of the SCB (see also Table 4).

SCB Parameter	Value
Nominal current I_{SCBn}	20 kA DC
Interrupting capability (including safety factor)	25 kA DC
Maximum current unbalance factor ΔI_{branch}	20%
Minimum repetition time	1800 s
Current direction	Unidirectional
Maximum voltage between terminals	5 kV
Highest voltage for equipment (IEC 60071)	7.2 kV rms
Switch-on/off time	≤1 ms
Operation accuracy/repeatability	≤0.5 ms
Accuracy of current measurements	1%
Bandwidth of current measurements	5 kHz

8.9.2 Static circuit breaker (SCB)



The specific aim of the SCB is to support the BPS in the diversion of the DC current towards the resistance R1 at the breakdown. When the SCB closes, most of the BPS current is diverted into the SCB, also thanks to the resistance in series with the BPS.

Table 8 summarizes some parameters on which the SCB design shall be based. Moreover, the IS shall consider all the other specifications included in this document.

On the basis of the technical specifications and of the information provided by the manufacturer of the static devices, the IS should select: the SCB scheme, the type of static device (e.g. IGCT) and the number of static devices and elements. The reasons for the choices shall be clearly pointed out in the technical section of the IS proposal, including both the manufacturer data and the IS valuations (scheme, calculations, simulations, etc.). The IS shall demonstrate the achievement of the required performances by the documents of the component manufacturer. The device data (type, size, numbers, etc.) can change in the final design by mutual consent between the IS and the Customer (anyway, the reasons for the modifications should be clearly pointed out).

The IS shall ensure and prove a current safety factor greater than 1.25 (on the basis of the selected component specifications), while the voltage safety factor shall be greater than 1.15, considering the value of the resistors resulting from an adiabatic heating.

The selected SCB semiconductors and related components shall sustain the maximum conduction time depending on the SNU operational sequence in both normal and fault conditions.

 Italian National Agency for New Technologies, Energy and Sustainable Economic Development	 UTFUS Fusion EURATOM-ENEA Association	Report Ricerca di Sistema Elettrico Accordo di Programma Ministero dello Sviluppo Economico: Specifiche tecniche per la realizzazione degli switching network unit dei solenoidi centrali del tokamak JT-60SA	ENEA ID: RT-JT60-SA-007	Page: 31/37
			Autore: Alessandro Lampasi	Rev. 0 Nov 2011

In case of a SCB designed by parallel branches, an equal sharing of the current in the branches should be ensured. This target will be quantified by the current unbalance factor ΔI_{branch} , defined in the technical specifications. Current measurements shall be performed in each branch to verify the level of ΔI_{branch} .

Independently of the values indicated in the tables, the measurement accuracy, bandwidth, sampling time and time delay shall be adequate to verify and control the current in each branch of the SCB and the SNU operational times.

Analogously, in case of a SCB designed by a series of static devices parallel branches, also the sharing of the voltage in every working state (switch on/off, transients) must be considered and tested.

In case of a fault that opens a single SCB branch, the other parallel branches shall sustain the consequent current increasing for the time needed to realize an internal protection (e.g. BPS closing and SCB opening).

Snubber and clamp circuits should be inserted in the SCB unit to guarantee a proper turn-on/off process and that the component always operates in its “safe operating area”.

8.9.3 Breakdown resistors

The accuracy on the resistor values at 20°C shall be within $\pm 2\%$ of the nominal values, while their increase due to the temperature shall be at maximum 10% of the nominal ones at the end of the operation shot.

The IS shall verify the compatibility between the voltage on the SNU terminals due to the resistors and the voltage limits of the SCB components (including the safety factor).

In order to facilitate the switch commutations and to prevent any dangerous overvoltage at the SCB switching off, the resistors and all the internal connections shall present very low stray inductances (anti-inductive type/arrangement).

The temperature of each SNU resistor shall be monitored by a measurement system. The SNU heat losses cannot be dissipated into the installation room, so the units shall be placed inside metallic enclosures from which the heat can be removed by the raw water plant.

8.9.4 Power connections

The internal power connections and terminations shall be mechanically strong and thermally adequate. The impedance of the connections among the BPS, the SCB and the resistors shall be minimized in order to guarantee that the current commutations are completed in a time consistent with the requirements on the SNU switching times.

The selectors C11, C12, C13, C14 and C2 shall be designed on the base of the specifications of the corresponding resistance. Their switching shall be commanded by the LCC through a servomechanism (pneumatic, electric). The pre-arranged opened/closed status of the selectors shall be stored in the LCC that will transmit it to the PS SC by a coded signal.

8.9.5 Grounding connections



The IS shall realize the internal grounding connections between the SNU parts with copper conductors of adequate cross-sections, sized to carry the fault current without voltage rises dangerous for the human safety.

All power ground connections for SNU high-voltage equipments shall be designed according to the IEC standards. All the ground conductors shall be easily accessible. The connection between one of the SNU ground bolts and the building grounding network will be realized by JAEA.

8.9.6 Safety grounding switches

The entire equipment shall be designed, manufactured and tested according to the IEC safety standards.

The access to the SNU high-voltage components must be possible only under the best safety conditions. Therefore, each SNU shall be equipped with two grounding switches (GSs) connected to its power input and output terminals. The doors (or any other entrance) of the SNU high-voltage enclosures

 <i>Italian National Agency for New Technologies, Energy and Sustainable Economic Development</i>	 UTFUS <i>Fusion EURATOM-ENEA Association</i>	Report Ricerca di Sistema Elettrico Accordo di Programma Ministero dello Sviluppo Economico: Specifiche tecniche per la realizzazione degli switching network unit dei solenoidi centrali del tokamak JT-60SA	ENEA ID: RT-JT60-SA-007	Page: 32/37
			Autore: Alessandro Lampasi	Rev. 0 Nov 2011

can be opened only after the closing of the grounding switches. Similarly, the grounding switches can be opened only after the closing of the enclosure doors.

The GS operation shall be motorized and allowed only in LCM. The GS operation shall be constrained by an interlock key system, connected with the high-voltage sources upstream and downstream the SNU. During the DDP, the Customer will give to the IS all the information and the procedures necessary to arrange the interlock system.

Limit switches will signal to the SCSDAS and SIS (through the LCC) the open/close status of the GSs (an open contact in the limit switch means that the GS is closed to ground). Besides, light indications will be placed on the SNU enclosure.

9 Testing and approval requirements

The whole of the provided equipment shall be subjected to inspections and tests to prove the compliance with the technical specifications both during manufacturing at the IS Facilities and during the commissioning at the JT-60SA Site.

The IS shall submit a Site Commissioning Program as described in Section 8.3.4 of the technical specifications.

During the testing activities, the IS shall apply and follow all the requirements and rules reported in [ANX2] and [ANX4].

The following sections outline the tests to be performed and the relevant test conditions determined on the basis of the reference design. The IS shall propose a complete testing plan, including modifications and integrations in relation to his design modifications, which shall be agreed with the Customer.

Factory Type Tests (see Section 5.24 of the technical specifications) shall be performed on the first SNU (prototype). The production of the other units shall depend on the positive results of such tests.

The IS shall prepare a document containing the procedures for the Factory Type Tests. This document shall be delivered at least 3 months before the starting of the tests. During the phase of manufacturing of the remaining units, the IS shall deliver the procedures for the Factory Routine Tests (see Section 5.34 of the technical specifications) at least 3 months before the starting of the Factory Routine Tests. Both the test procedures shall be approved by the Customer.

The Customer and/or F4E and/or JAEA representatives and/or the Project Leader or their delegated persons may witness all the Factory Type and Factory Routine Tests. To this aim, the Customer shall be informed about the relevant dates at least two weeks before their occurrence.



Within 45 days after the successful conclusion of each test, a report shall be prepared by the IS and submitted to the Customer for approval. This report shall include all the test conditions used testing procedures and all the records, certificates and performance curves resulting from the tests. These test records, certificates and performance curves shall be provided for all the tests, whether or not they have been witnessed by the Customer.

Site Acceptance Tests (see Section 5.44 of the technical specifications) shall be performed on the whole system and are aimed at verifying the equipment insulation and the coordinated performances of the equipment.

Before any equipment is packed and dispatched from the IS's works, all the requested factory tests shall have been successfully carried out in the presence of a representative of the Customer, unless otherwise agreed.

Any item of equipment or component failing to comply with the requirements of these specifications in any respect or at any stage of manufacture, or test, shall be rejected by the Customer either in whole or in part as the Customer considers necessary. The IS shall provide for the revised product, at his own charge, to fulfill the failed requirements. This fulfillment shall be proved by new inspections and/or tests.

Approval of any test by the Customer does not relieve the IS from his obligation to meet the requirements of the specifications.

 <i>Italian National Agency for New Technologies, Energy and Sustainable Economic Development</i>	 UTFUS <i>Fusion EURATOM-ENEA Association</i>	Report Ricerca di Sistema Elettrico Accordo di Programma Ministero dello Sviluppo Economico: Specifiche tecniche per la realizzazione degli switching network unit dei solenoidi centrali del tokamak JT-60SA	ENEA ID: RT-JT60-SA-007	Page: 33/37
			Autore: Alessandro Lampasi	Rev. 0 Nov 2011

10 Packing and transport requirements

The IS shall be responsible for the transport, including packaging, handling and storage during the transport, of his contributions to the PoE in Japan [ANX6]. JAEA shall be responsible for transport, including handling and storage, during the transport from the PoE to the Naka Site.

The IS shall issue, at least 10 months before transportation to Japan, the “Specifications for Handling and Transportation” of all the procured components. These specifications shall include, at least, the dimension and weight of each transported package and the detailed instructions to properly handle and transport each package.

In any case, the IS shall maintain, with respect to the Customer, the full responsibility of the procurement. For this scope, the IS shall include in each package any stress sensor and provision to effectively monitor and verify that the package itself and anything included is substantially sound.

11 Identification and traceability requirements

The IS shall identify all the components by a metallic or plastic plate attached to the component, in which the identification code (IDC) is written.

This IDC shall correspond to the name of the component that will be indicated by the Customer during the DDP. The same name shall be used in the technical documentation.

During the DDP, the IS shall propose a list of the components needing traceability. This list will be discussed and approved by Customer. The list shall include all the components/sub-systems whose failure could imply an out-of-service of the SNUs.

The IDC plate attached to a component belonging to this list shall also contain the serial number. The serial number shall allow the identification of the record containing information about the traceability of the component.

For the more standard components, not included in this list, the IS shall indicate however the necessary information for their easy procurement.

Records of the traceability of each component shall be stored and kept by the IS for at least 10 years (or the regulatory period of time, if longer). The records shall contain all the information to recognize the production process, utilized material, manufacturer, etc.

12 Documentation to be supplied



The final documentation shall include all the documentation described in the technical specifications, including all the revisions performed during the installation and the tests.

13 Training

The IS shall provide training for the JT-60SA operating staff, in the operation, maintenance and troubleshooting of the supply.

Training shall be in the following forms:

- Preparation of an “Operation and Maintenance Manual” written in such a way that on-site technical staff may get a good understanding of the equipment, of its mode of operation and of the procedures to carry out setting and checks of protections, controls loops, maintenance interventions, etc.
- Informal instruction during the execution of the Contract, especially during testing at the IS’s Facilities and Site testing and commissioning. When Representatives of the Customer/F4E/JAEA

 <i>Italian National Agency for New Technologies, Energy and Sustainable Economic Development</i>	 UTFUS <i>Fusion EURATOM-ENEA Association</i>	Report Ricerca di Sistema Elettrico Accordo di Programma Ministero dello Sviluppo Economico: Specifiche tecniche per la realizzazione degli switching network unit dei solenoidi centrali del tokamak JT-60SA	ENEA ID: RT-JT60-SA-007	Page: 34/37
			Autore: Alessandro Lampasi	Rev. 0 Nov 2011

are present they shall be allowed to ask a reasonable number of questions and/or seek clarifications without unduly delaying the IS activities.

- A formal presentation (in English) to the Site technical staff lasting up to two days. The IS shall give the presentation, unless differently agreed with the Customer.
- Instruction on the use of programmers and source code for any programmable device.
- Availability to provide additional training, at JAEA expenses, if requested within one year from the acceptance of the system.

14 Site conditions

14.1 Ambient conditions

The equipment shall be installed in Naka, Ibaraki, Japan, at the JAEA Site. The magnetic field in these areas, due to the JT-60SA operation, will be less than 5 mT.

The environmental conditions of the site are summarized in Table 10-1 of the technical specifications (see also Table 2.7-13 of the PID [ANX1]).

14.2 Seismic events (only for information)

Some information about seismic events in Naka Site are given in Section 1.8.3 of the PID [ANX1]. They are summarized in Table 10-2 of the technical specifications. The floor acceleration is calculated as the product of the ground acceleration, of the superelevation factor and of the direction factor.

14.3 Facilities in the PS buildings

The JAEA cooling system will provide raw water and a circuit for demineralized water dedicated to aluminum components.

The main parameters of the demineralized water cooling system for aluminum components and of the raw water cooling system (JT-60SA Secondary Cooling System) are summarized in Table 10-3 of the technical specifications. The reported values are derived from the Tables 2.7-14 and 2.7-15 of the PID [ANX1] in which some data are still to be confirmed.

The values reported for the water supply temperature refer to the operation periods. In other periods, the minimum water temperature can be 10 °C.

JAEA will provide air ventilation for the power supply rooms. The parameters of the air ventilation system are summarized in Table 10-4. These data can be derived from Table 2.7-13 of the PID [ANX1] referring to the Rectifier Room where the SNU shall be installed.

Without considering the equipment operations, the air ventilation system is designed to guarantee the maximum indoor temperature and indoor humidity indicated in Table 10-4 of the technical specifications. These values must be intended as averages in the whole room volume.

The ventilation is provided by ducts and openings whose layout is shown in [DWG4].

JAEA will distribute in the JT-60SA buildings compressed air with a pressure of 1.5 MPa without major impurities, dry and lubricated.

15 Quality assurance documents

The Quality Assurance provisions are regulated by the annexed document [ANX7].

The IS shall provide information and, preferably, evidences on the reliability of the offered equipment.

The IS shall indicate the times necessary for the substitution of the main components in case of faults.

The IS shall provide a realistic assessment of the necessary maintenance requirements over the first 10-year period of operation.

16 International standards

All the supplied equipment shall be designed, manufactured and tested in accordance with the most updated issues of the relevant IEC Standards and Recommendations.

In particular, the following standards are explicitly cited in the technical specifications.

Standard Reference	IEC Reference Code	Standard Title
[STD1]	IEC 60071 series	Insulation co-ordination
	IEC 60071-2	Part 2: Application guide
[STD2]	IEC 60146-1-1	Semiconductor converters – General requirements and line commutated converters – Part 1-1: Specification of basic requirements
[STD3]	IEC 60204-11	Safety of machinery – Electrical equipment of machines – Part 11: Requirements for HV equipment for voltages above 1000 V a.c. or 1 500 V d.c. and not exceeding 36 kV
[STD4]	IEC 60332 series	Tests on electric and optical fibre cables under fire conditions
[STD5]	IEC 60502 series	Power cables with extruded insulation and their accessories for rated voltages from 1 kV up to 30 kV
[STD6]	IEC 60529	Standard Degrees of protection provided by enclosures (IP Code)
[STD7]	IEC 60754 series	Test on gases evolved during combustion of materials from cables
[STD8]	IEC 61000 series	Electromagnetic compatibility (EMC)
	IEC 61000-5-7	Part 5-7: Installation and mitigation guidelines – Degrees of protection provided by enclosures against electromagnetic disturbances (EM code)
	IEC 61000-6-2	Part 6-2: Generic standards – Immunity for industrial environments
[STD9]	IEC 61800-3	Adjustable speed electrical power drive systems – Part 3: EMC requirements and specific test methods
[STD10]	IEC 62271 series	High-voltage switchgear and controlgear
	IEC 62271-102	Part 102: Alternating current disconnectors and earthing switches
	IEC 62271-200	Part 200: A.C. metal-enclosed switchgear and controlgear for rated voltages above 1 kV and up to and including 52 kV

17 Annexed drawings

The drawings in the table are provided to the potential IS.

The reference tables report, if available, the unique identifier (UID) of the documents in the Broader Approach Document Management System (JT-60SA DMS). The UID provides also a hyperlink to the JT-60SA DMS website containing the updated version of the documents (JAEA version) and the related information. The access to this website is restricted to the authorized users.

Drawing Reference	Drawing Title (JAEA version)	Drawing Title (ENEA version)	JT-60SA DMS (PDF format)
[DWG1]	JT60SA-G-000215, Layout of Devices on Power Supplies (second floor)	ENEA-ING-A-JT-009/L, Devices in Power Supplies Areas	BA D 2273HC
[DWG2]	JT60SA-G-000214, Layout of Devices in Power Supplies (first floor)	ENEA-ING-A-JT-006/L, Layout Power Supply main components. Rectifier Building 1 st floor	BA D 226HDY
[DWG3]	JT60SA-G-000287, Floor Load of JT-60 Rectifier Building (second floor)	ENEA-ING-A-JT-0010/L, Layout of Power Supply main components. Load capability of Rectifier Building 2 nd Floor	BA D 224F44
[DWG4]	JT60SA-G-000217-0, Cross section of Ventilation system in Rectifier Building (second floor)	Not available	BA D 2272UT

18 Annexed documents

The documents in the table are provided to the potential IS. The reference tables report, if available, the UID of the documents in the JT-60SA DMS.

Annex Reference	Annex Title	JT-60SA DMS
[ANX1]	Plant Integration Document (PID)	BA D 222UJY
[ANX2]	Power Supplies Installation Works at JT-60SA Site – General Conditions for EU-Suppliers	In preparation
[ANX3]	Services at Naka Site for Installation	BA D 22E3Z8
[ANX4]	Regulations at Naka Site for Installation	BA D 224GP3
[ANX5]	JT-60SA Power Supply System Recovery Sequence in Case of Fault	BA D 224GM4
[ANX6]	Definition of SNU PoE in Japan	BA D 22CRTA
[ANX7]	Industrial Supplier Quality Requirements (by ENEA)	In preparation

19 Reference documents

The reference tables report, if available, the UID of the documents in the JT-60SA DMS.

Document Reference	Document Title	JT-60SA DMS
[REF1]	Withstand Test Voltage (in .xls format)	BA_D_223XRJ
[REF2]	JT-60SA Power Supply, Summary of Signals to be exchanged among each components and magnet PS supervising controller	BA_D_224L2W
[REF3]	Address map of RM for PS control system	BA_D_229P2K